

Radio-TV SIGNAL DESCRAMBLING

\$1.95 AUGUST 1986
IN CANADA \$2.50

Electronics

TECHNOLOGY - VIDEO - STEREO - COMPUTERS - SERVICE

BUILD THIS RADAR SPEED-GUN CALIBRATOR

Generate false targets
on X and K bands!

COMPACT DISCS

They're more than digital audio

POCKET-TV ROUNDUP

Set-by-set descriptions

BUILD A STEREO AMPLIFIER

High power FET performance

BUILD A REMOTE POWER SWITCH

Add remote-control convenience
to all your line-powered devices

OSCILLATORS

Designing LC feedback oscillators

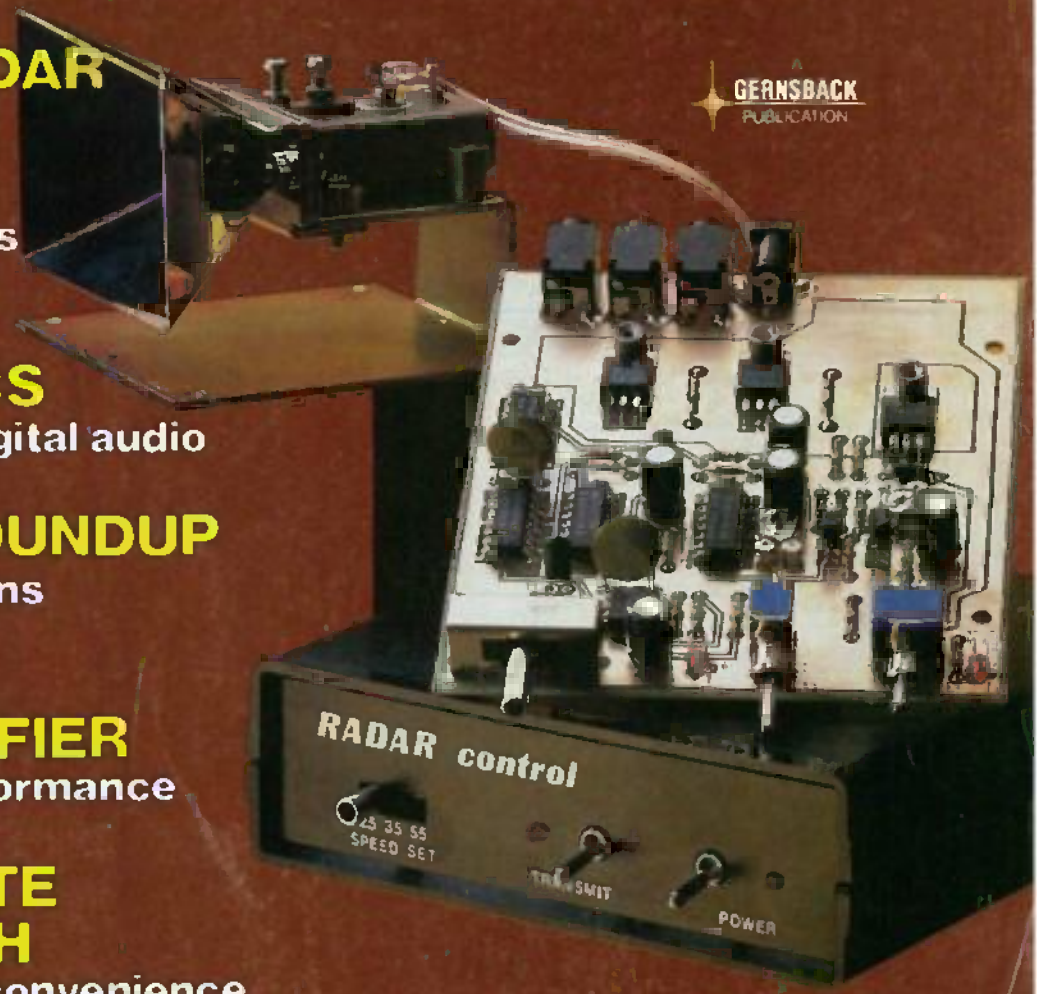

A
GERNSBACK
PUBLICATION

PLUS:

- ★ Ask R-E
- ★ Satellite TV
- ★ New Products
- ★ PC Service
- ★ Robotics
- ★ New Ideas
- ★ Antique Radios
- ★ **COMPUTER DIGEST**

Now! Tek quality and expert advice are just a free phone call away!

The industry standard in CRT performance.

Crisp, easy-to-read, bright CRT; 14kV accelerating potential, provides high writing rate and small spot size. Full size 8x10 cm display for measurement accuracy.

Display controls are flexible and easy to use.

Separate intensity controls reduce blooming in alternate sweep mode. Focus tracking minimizes control adjustment and BEAM FIND eliminates confusion.

Vertical system provides measurement assurance.

Flat transient response and high accuracy ensures true reproduction of your signals. Fast risetime and high bandwidth is well suited for a variety of measurement.

Perform delayed sweep measurements accurately and easily.

Both sweeps can be displayed alternately making differential measurements easy and accurate (1%). An interlocking SEC/DIV control simplifies set-up.

Stable hands-off triggering.

P-P AUTO detects signal peaks, then sets the trigger level for you. Display asynchronous signals using VERT MODE triggering. Independent TV field and line selection.

Front panel laid out by function for ease of use.

Color coding aids the user in operation. Functions and modes are placed logically. All nomenclature is clearly labeled, and protected behind a scratchless Lexan surface.

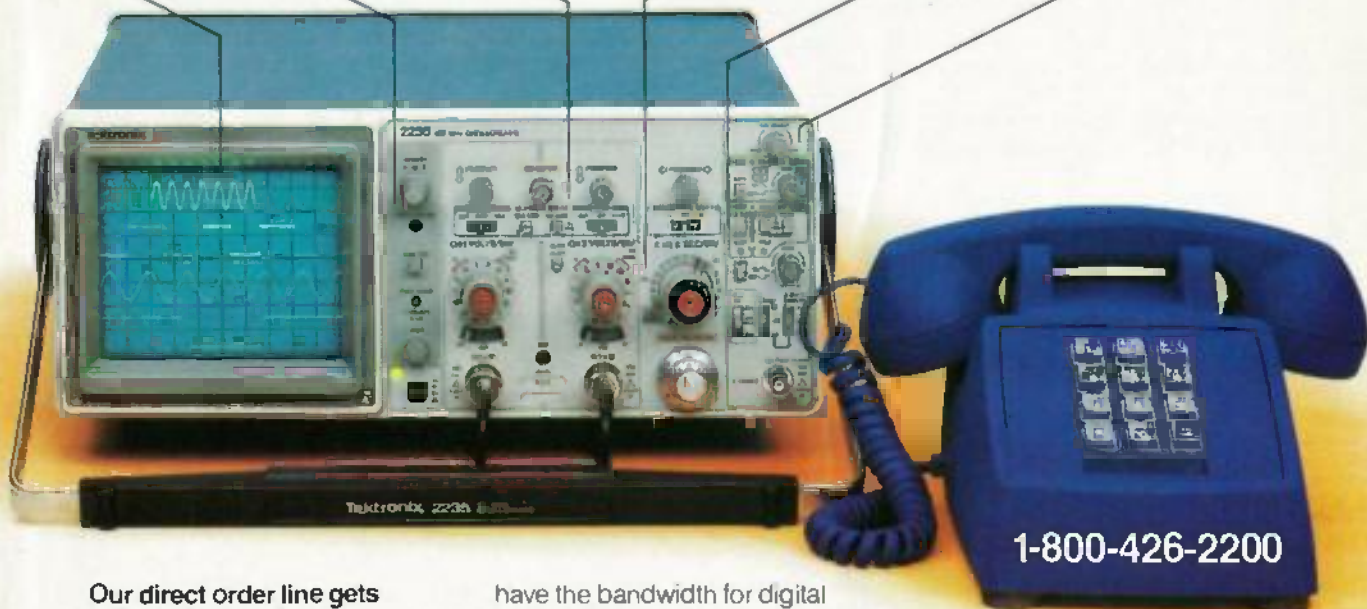

1-800-426-2200

Our direct order line gets you the industry's leading price-performance portables... and fast answers from experts!

The 60 MHz single time base delay 2213A, the 60 MHz dual time base 2215A and the 100 MHz dual time base 2235 offer unprecedented reliability and affordability, plus the industry's first 3-year warranty* on labor and parts. CRT included.

The cost: just \$1275 for the 2213A, \$1525 for the 2215A, \$1750 for the 2235.† Even at these low prices, there's no scrimping on performance. You

have the bandwidth for digital and analog circuits. The sensitivity for low signal measurements. The sweep speeds for fast logic families. And delayed sweep for fast, accurate timing measurements. All scopes are UL Listed and CSA approved.

You can order, or obtain literature, through the Tek National Marketing Center. Technical personnel, expert in scope applications, will answer your questions and expedite delivery. Direct orders include comprehensive 3-year warranty*, operator's

manual, two 10X probes, 15-day return policy and worldwide service backup.

**Order toll free:
1-800-426-2200,
Ask for Rick.**

In Oregon, call collect:
(503) 627-9000.
Or write Tektronix, Inc.
P.O. Box 1700
Beaverton, OR 97075

Tektronix
COMMITTED TO EXCELLENCE

AUGUST '86

**Radio-
Electronics**

Electronics publishers since 1908

Vol. 57 No. 8

SPECIAL FEATURE

- 39 POCKET TELEVISION RECEIVERS**
Part 2. Here's a round-up of the pocket-TV market. We show you what's available, for how much, and the performance you can expect.
Fred Blechman

BUILD THIS

- 47 RADAR SPEED-GUN CALIBRATOR**
You can also use it to test radar detector!
Anthony Stevens
- 43 REMOTE-CONTROLLED POWER SWITCH**
Add hi-tech convenience to all your equipment!
Daniel B. Cooper
- 57 HIGH-POWER FET STEREO AMP**
Here's an excellent way to upgrade your outdated system!
- 65 PC SERVICE**
Use our exclusive direct-etch foil patterns to make circuit boards for your radar-gun calibrator and remote power switch.

TECHNOLOGY

- 6 VIDEO NEWS**
Inside the fast-changing video scene.
David Lachenbruch
- 62 COMPACT DISCS BIT-BY-BIT**
What's on a compact disc? It's more than music!
Josef Bernard
- 69 SATELLITE TV**
MA/Com scrambling hardware.
Bob Cooper, Jr.
- 71 ROBOTICS**
Tactile sensors for robots.
Mark J. Robillard

CIRCUITS AND COMPONENTS

- 29 NEW IDEAS**
A simple cable tester
- 51 TV SIGNAL DESCRAMBLING**
Part 3. We continue our series with a look at suppressed-sync scrambling schemes.
William Sheets and Rudolf F. Graf
- 54 HOW TO DESIGN OSCILLATOR CIRCUITS**
Part 2. A look at L-C feedback oscillators.
Joseph J. Carr
- 75 SERVICE CLINIC**
Replacing transistors.
Jack Darr
- 76 SERVICE QUESTIONS**
Solutions to servicing problems.
- 79 STATE OF SOLID STATE**
Chopper-stabilized op-amps.
Robert F. Scott
- 83 DESIGNER'S NOTEBOOK**
A simple audio oscillator.
Robert Grossblatt

RADIO

- 77 ANTIQUE RADIOS**
Antique radio testing equipment.
Richard D. Fitch
- 81 COMMUNICATIONS CORNER**
Power-line spikes and solutions
Herb Friedman

COMPUTERS

Following
page 68

- COMPUTER DIGEST**
Speech synthesis, transistor switching circuits, retrofitting and printers, and more!
- 73 DRAWING BOARD**
Bank switching memory systems.
Robert Grossblatt

EQUIPMENT REPORTS

- 22 B + K Dynascan TTL IC Tester**
- 27 Nady WTS-1 Wireless Speaker System**

DEPARTMENTS

- 108 Advertising and Sales Offices**
- 108 Advertising Index**
- 10 Ask R-E**
- 109 Free Information Card**
- 12 Letters**
- 87 Market Center**
- 30 New Products**
- 4 What's News**

RADIO-ELECTRONICS, (ISSN 0033-7862) August 1986. Published monthly by Gernsback Publications, Inc., 500-B Bi-County Boulevard, Farmingdale, NY 11735. Second-Class Postage paid at Farmingdale, NY and additional mailing offices. Second-Class mail registration No. 9242 authorized at Toronto, Canada. One-year subscription rate U.S.A. and possessions \$18.97. Canada \$20.97, all other countries \$23.47. Subscription orders payable in US funds only, international postal money order or check drawn on a U.S.A. bank. Single copies \$1.95. © 1986 by Gernsback Publications, Inc. All rights reserved. Printed in U.S.A.

POSTMASTER: Please send address changes to RADIO-ELECTRONICS, Subscription Dept., Box 55115, Boulder, CO 80321-5115. A stamped self-addressed envelope must accompany all submitted manuscripts and/or artwork or photographs if their return is desired should they be rejected. We disclaim any responsibility for the loss or damage of manuscripts and/or artwork or photographs while in our possession or otherwise.

AUGUST 1986

COVER 1



Here's an easy-to-build instrument for calibrating radar speed guns. Simply set the calibrator's output to 25, 35 or 55 miles per hour, and your radar speed-gun should show the proper reading. A different reading indicates that your speed gun is out of calibration. The calibrator works by outputting a pulsed carrier on either the X or K radar bands. The signal appears to the radar gun to be the reflection of a speeding object.

Even if you have no need for a calibrator, this article is a good way to learn about Gunn diodes and radar technology.

NEXT MONTH

THE SEPTEMBER ISSUE IS ON SALE AUGUST

BUILD A PLANT-WATER MONITOR
Keep your plants thriving.

TV SIGNAL SCRAMBLING
Our series continues

BUILD A STUN GUN
High-voltage generator

THE 4007
An indepth look at one of the most versatile CMOS IC's.

Radio Electronics

Hugo Gernsback (1884-1967) founder
M. Harvey Gernsback,
editor-in-chief, emeritus

Larry Steckler, EHF, CET, editor-in-chief
and publisher

EDITORIAL DEPARTMENT

Art Kleiman, editorial director
Brian C. Fenton, managing editor
Carl Laron, WB2SLR, associate editor
Jeffrey K. Hiltzman,
assistant technical editor
Robert A. Young, assistant editor
Julian S. Martin, editorial associate
Byron G. Weis, editorial associate
M. Harvey Gernsback,
contributing editor
Jack Darr, CET, service editor
Robert F. Scott,
semiconductor editor
Herb Friedman,
communications editor
Bob Cooper, Jr., satellite-TV editor
Robert Grossblatt, circuits editor
David Lachenbruch,
contributing editor
Richard D. Fitch,
contributing editor
Mark L. Robillard, robotics editor
Teri Scaduto Wilson, editorial assistant
Judith Kaplan, editorial assistant

PRODUCTION DEPARTMENT

Ruby M. Yee, production director
Robert A. W. Lowndes,
editorial production
Andre Duzant, technical illustrator
Karen Tucker, advertising production
Geoffrey S. Weil, production traffic

CIRCULATION DEPARTMENT

Jacqueline P. Cheeseboro,
circulation director
Wendy Alanko,
circulation analyst
Theresa Lombardo,
circulation assistant

Cover photo by Robert Lewis

Typography by Mares Graphics

Radio-Electronics, Gernsback Publications, Inc., Executive Offices, 500-B Bi-County Blvd., Farmingdale, NY 11735, 516-293-3000

Radio-Electronics is indexed in *Applied Science & Technology Index* and *Readers Guide to Periodical Literature*.

Microfilm & microfiche editions are available. Contact circulation department for details.

Advertising Sales Offices listed
on page 108.



NEW! Lower Price Scanners

Communications Electronics,[™] the world's largest distributor of radio scanners, introduces new lower prices to celebrate our 15th anniversary.

Regency[®] MX7000-EA

List Price \$699.95/CE price \$399.95/SPECIAL
10-Band, 20 Channel • Crystalline • AC/DC
Frequency range: 25-550 MHz, continuous coverage and 800 MHz, to 1.3 GHz, continuous coverage.
The Regency MX7000 scanner lets you monitor Military, Space Satellites, Government, Railroad, Justice Department, State Department, Fish & Game, Immigration, Marine, Police and Fire Departments, Broadcast Studio Transmitter Links, Aeronautical AM band, Aero Navigation, Paramedics, Amateur Radio, plus thousands of other radio frequencies most scanners can't pick up. The Regency MX7000 is the perfect scanner to receive the exciting 1.3 GHz, amateur radio band.

Regency[®] Z60-EA

List Price \$299.95/CE price \$179.95/SPECIAL
8-Band, 60 Channel • No Crystal scanner
Bands: 30-50, 88-108, 118-138, 144-174, 440-512 MHz.
The Regency Z60 covers all the public service bands plus aircraft and FM music for a total of eight bands. The Z60 also features an alarm clock and priority control as well as AC/DC operation. Order today.

Regency[®] Z45-EA

List Price \$259.95/CE price \$159.95/SPECIAL
7-Band, 45 Channel • No Crystal scanner
Bands: 30-50, 118-138, 144-174, 440-512 MHz.
The Regency Z45 is very similar to the Z60 model listed above however it does not have the commercial FM broadcast band. The Z45, now at a special price from Communications Electronics.

Regency[®] RH250B-EA

List Price \$674.30/CE price \$329.95/SPECIAL
10 Channel • 25 Watt Transceiver • Priority
The Regency RH250B is a ten-channel VHF land mobile transceiver designed to cover any frequency between 150 to 162 MHz. Since this radio is synthesized, no expensive crystals are needed to store up to ten frequencies without battery backup. All radios come with CTCSS tone and scanning capabilities. A monitor and night/day switch is also standard. This transceiver even has a priority function. The RH250 makes an ideal radio for any police or fire department volunteer because of its low cost and high performance. A 60 Watt VHF 150-162 MHz, version called the RH600B is available for \$454.95. A UHF 15 watt version of this radio called the RU150B is also available and covers 450-482 MHz, but the cost is \$449.95.

NEW! Bearcat[®] 50XL-EA

List Price \$199.95/CE price \$114.95/SPECIAL
10-Band, 10 Channel • Handheld scanner
Bands: 29-54, 136-174, 406-512 MHz.
The Uniden Bearcat 50XL is an economical, hand-held scanner with 10 channels covering ten frequency bands. It features a keyboard lock switch to prevent accidental entry and more. Also order part # BP50 which is a rechargeable battery pack for \$14.95, a plug-in wall charger, part # AD100 for \$14.95, a carrying case part # VC001 for \$14.95 and also order optional cigarette lighter cable part # PS001 for \$14.95.

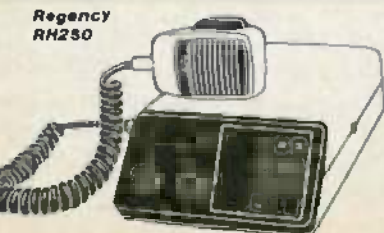

NEW! Scanner Frequency Listings

The new Fox scanner frequency directories will help you find all the action your scanner can listen to. These new listings include police, fire, ambulances & rescue squads, local government, private police agencies, hospitals, emergency medical channels, news media, forestry radio service, railroads, weather stations, radio common carriers, AT&T mobile telephone, utility companies, general mobile radio service, marine radio service, taxi cab companies, low truck companies, trucking companies, business repeaters, business radio (simplex) federal government, funeral directors, veterinarians, buses, aircraft, space satellites, amateur radio, broadcasters and more. Fox frequency listings feature call letter cross reference as well as alphabetical listing by licensee name, police codes and signals. All Fox directories are \$14.95 each plus \$3.00 shipping. State of Alaska-RL021-1; State of Arizona-RL025-1; Baltimore, MD/Washington, DC-RL024-1; Buffalo, NY/Erie, PA-RL009-2; Chicago, IL-RL014-1; Cincinnati/Dayton, OH-RL008-2; Cleveland, OH-RL017-1; Columbus, OH-RL003-2; Dallas/Ft. Worth, TX-RL013-1; Denver/Colorado Springs, CO-RL027-1; Detroit, MI/Windsor, ON-RL008-3; Fort Wayne, IN/Lima, OH-RL001-1; Hawaii/Guam-RL015-1; Houston, TX-RL023-1; Indianapolis, IN-RL022-1; Kansas City, MO/KS-RL011-2; Long Island, NY-RL026-1; Los Angeles, CA-RL016-1; Louisville/Lexington, KY-RL007-1; Milwaukee, WI/Waukegan, IL-RL021-1; Minneapolis/St. Paul, MN-RL010-2; Nevada/E. Central CA-RL028-1; Oklahoma City/Lawton, OK-RL005-2; Orlando/Daytona Beach, FL-RL012-1; Pittsburgh, PA/Wheeling, WV-RL029-1; Rochester/Syracuse, NY-RL020-1; San Diego, CA-RL018-1; Tampa/St. Petersburg, FL-RL004-2; Toledo, OH-RL002-3. New editions are being added monthly. For an area not shown above call Fox at 800-543-7892. In Ohio call 800-621-2513.

NEW! Regency[®] HX1200-EA

List Price \$369.95/CE price \$214.95/SPECIAL
8-Band, 45 Channel • No Crystal scanner
Search • Lockout • Priority • Scan Delay
Sidell liquid crystal display • EARMemory
New Direct Channel Access Feature
Bands: 30-50, 118-138, 144-174, 406-512 MHz.
The new handheld Regency HX1200 scanner is fully keyboard programmable for the ultimate in versatility. You can scan up to 45 channels at the same time including the AM aircraft band. The LCD display is even sidellit for night use. Order MA-256-EA rapid charge drop-in battery charger for \$84.95 plus \$3.00 shipping/handling. Includes wall charger, carrying case, belt clip, flexible antenna and nicad battery.

NEW! Bearcat[®] 100XL-EA

List Price \$349.95/CE price \$203.95/SPECIAL
8-Band, 16 Channel • Priority • Scan Delay
Search • Limit • Hold • Lockout • AC/DC
Frequency range: 30-50, 118-174, 406-512 MHz.
The world's first no-crystal handheld scanner now has a LCD channel display with backlight for low light use and aircraft band coverage at the same low price. Size is 1 1/2" x 7 1/2" x 2 1/2". The Bearcat 100XL has wide frequency coverage that includes all public service bands (Low, High, UHF and "T" bands), the AM aircraft band, the 2-meter and 70 cm, amateur bands, plus military and federal government frequencies. Wow...what a scanner! Included in our low CE price is a sturdy carrying case, earphone, battery charger/AC adapter, six AA nicad batteries and flexible antenna. Order your scanner now.

Bearcat[®] 210XW-EA

List Price \$339.95/CE price \$209.95/SPECIAL
8-Band, 20 Channel • No-crystal scanner
Automatic Weather • Search/Scan • AC/DC
Frequency range: 30-50, 136-174, 406-512 MHz.
The new Bearcat 210XW is an advanced 3rd generation scanner with great performance at a low CE price.

NEW! Bearcat[®] 145XL-EA

List Price \$179.95/CE price \$102.95/SPECIAL
10 Band, 16 channel • AC/DC • Instant Weather
Frequency range: 29-54, 136-174, 420-512 MHz.
The Bearcat 145XL makes a great first scanner. Its low cost and high performance lets you hear all the action with the touch of a key. Order your scanner from CE today.

TEST ANY SCANNER

Test any scanner purchased from Communications Electronics for 31 days before you decide to keep it. If for any reason you are not completely satisfied, return it in original condition with all parts in 31 days, for a prompt refund (less shipping/handling charges and rebate credit).

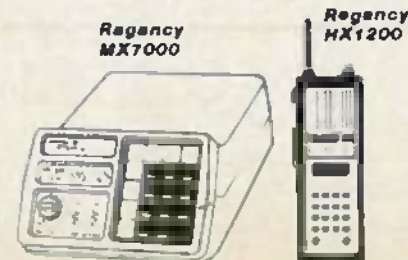

CIRCLE 79 ON FREE INFORMATION CARD

NEW! Bearcat[®] 800XLT-EA

List Price \$499.95/CE price \$317.95
12-Band, 40 Channel • No-crystal scanner
Priority control • Search/Scan • AC/DC
Bands: 29-54, 118-174, 406-512, 806-912 MHz.
The Uniden 800XLT receives 40 channels in two banks. Scans 15 channels per second. Size 9 1/2" x 4 1/2" x 1 1/2".

OTHER RADIOS AND ACCESSORIES

Panasonic RF-2800-EA Shortwave receiver... \$179.95
RD95-EA Uniden Remote Mount CB Detector... \$129.95
RD93-EA Uniden Visor Mount Radar Detector... \$98.95
RD9-EA Uniden "Passport" size Radar Detector... \$239.95
BC-WA-EA Bearcat Weather Alert... \$49.95
DX1000-EA Bearcat shortwave receiver SALE... \$349.95
PC22-EA Uniden remote mount CB transceiver... \$99.95
PC55-EA Uniden mobile mount CB transceiver... \$59.95
R1080-EA Regency 10 channel scanner SALE... \$92.95
MX3000-EA Regency 30 channel scanner... \$198.95
XL155-EA Regency 10 channel scanner SALE... \$129.95
UC102-EA Regency VHF 2 ch. 1 Watt transceiver... \$126.95
RH250B-EA Regency 10 ch. 25 Watt VHF trans... \$329.95
RH600B-EA Regency 10 ch. 60 Watt VHF trans... \$454.95
RU150B-EA Regency 10 channel UHF transceiver... \$499.95
P1405-EA Regency 5 amp regulated power supply... \$69.95
P1412-EA Regency 12 amp reg. power supply... \$168.95
MA256-EA Drop-in charger for HX1000 & HX1200... \$84.95
MA257-EA Cigarette lighter cord for HX1200... \$19.95
MA917-EA Ni-Cad battery pack for HX1200... \$34.95
SMMX7000-EA Svc. man. for MX7000 & MX5000... \$19.95
SMMX3000-EA Service man. for Regency MX3000... \$19.95
B-4-EA 1.2 V AAA Ni-Cad batteries (set of four)... \$9.95
FB-E-EA Frequency Directory for Eastern U.S.A... \$12.95
FB-W-EA Frequency Directory for Western U.S.A... \$12.95
ASD-EA Air Scan Directory... \$14.95
RRF-EA Survival Radio Frequency Directory... \$14.95
TS8-EA "Top Secret" Registry of U.S. Govt. Freq... \$14.95
TIC-EA Techniques for intercepting Comm... \$14.95
RRF-EA Railroad frequency directory... \$10.95
CIE-EA Cover Intelligence Elect. Eavesdropping... \$14.95
A60-EA Magnet mount mobile scanner antenna... \$35.00
A70-EA Base station scanner antenna... \$35.00
USAMM-EA Mag mount VHF/UHF ant w/ 12' cable... \$39.95
USAK-EA "K" hole mount VHF/UHF ant w/ 17' cable... \$35.00
USATLM-EA Trunk lp mount VHF/UHF antenna... \$35.00
Add \$3.00 shipping for all accessories ordered at the same time.
Add \$12.00 shipping per shortwave receiver.
Add \$7.00 shipping per scanner and \$3.00 per antenna.

BUY WITH CONFIDENCE

To get the fastest delivery from CE of any scanner, send or phone your order directly to our Scanner Distribution Center. Michigan residents please add 4% sales tax or supply your tax I.D. number. Written purchase orders are accepted from approved government agencies and most well rated firms at a 10% surcharge for net 10 billing. All sales are subject to availability, acceptance and verification. All sales on accessories are final. Prices, terms and specifications are subject to change without notice. All prices are in U.S. dollars. Out of stock items will be placed on backorder automatically unless CE is instructed differently. A \$5.00 additional handling fee will be charged for all orders with a merchandise total under \$50.00. Shipments are F.O.B. Ann Arbor, Michigan. No COD's. Most products that we sell have a manufacturer's warranty. Free copies of warranties on these products are available prior to purchase by writing to CE. Non-certified checks require bank clearance. Not responsible for typographical errors.

Mail orders to: Communications Electronics,[™] Box 1045, Ann Arbor, Michigan 48106 U.S.A. Add \$7.00 per scanner for U.P.S. ground shipping and handling in the continental U.S.A. For Canada, Puerto Rico, Hawaii, Alaska, or APO/FPO delivery, shipping charges are three times continental U.S. rates. If you have a Visa Master Card or Discover Card, you may call and place a credit card order. Order toll-free in the U.S. Dial 800-USA-SCAN. In Canada, order toll-free by calling 800-221-3475. WUI Telex anytime, dial 671-0155. If you are outside the U.S. or in Michigan dial 313-973-8888. Order today. Scanner Distribution Center[™] and CE logos are trademarks of Communications Electronics Inc.
† Bearcat[®] is a registered trademark of Uniden Corporation.
‡ Regency is a registered trademark of Regency Electronics Inc. AD #051586-EA2

Copyright © 1986 Communications Electronics Inc.
For credit card orders call
1-800-USA-SCAN

**COMMUNICATIONS
ELECTRONICS INC.**

Consumer Products Division
P.O. Box 1045 □ Ann Arbor, Michigan 48106-1045 U.S.A.
Cell 800-USA-SCAN or outside U.S.A. 313-973-8888

WHAT'S NEWS

AM-stereo maker believes Motorola violates FCC rules

Kahn Communications, Inc., a Westbury, NY manufacturer of AM-stereo transmitters and receivers, has filed a complaint with the Federal Communications Commission, requesting an investigation of possible violations of FCC rules by the Motorola Corporation.

Kahn Communications is a competitor of Motorola. A substantial number of AM-stereo broadcast stations in the United States, Canada, and Mexico make use of Kahn equipment.

The complaint was based on measurements of the Motorola equipment, which showed that it exceeded the prescribed bandwidth, and also on a statement that

appeared in a brochure bearing the Motorola logo. That passage in question reads: "It is possible to force the system to exceed the FCC bandwidth limits...by a few decibels." FCC rules state that the transmitted signal must meet the occupied bandwidth specifications "under all possible conditions of program modulation."

Motorola's type acceptance, says Kahn, was based on an application that shows measurements up to only 75% modulation, and at frequencies not exceeding 5,000 Hz. While those measurements may account for the acceptance of the Motorola application, they cannot possibly be considered to represent "all possible conditions of modulation;" broadcasters modulate up to at least 100% and to 15 kHz.

Kahn Communications has re-

quested that—if the FCC confirms the violations—Motorola's type acceptance be revoked. That would require all stations using Motorola equipment to discontinue stereo broadcasting and would also require Motorola to immediately cease marketing the broadcasting equipment in question.

Amateurs man superstation at Vancouver World's Fair

A state-of-the-art amateur station is one of the features of Expo 86, the World's Fair of Transportation and Communication, held in Vancouver, British Columbia, Canada from May 2 to October 13 this year. The station is in the main hall of the Canada Pavilion, which is dramatically located in a spectacular harbor setting linked to the rest of Expo by a rapid-transit "Sky-Train."

The station operates on all bands, from 1800 kHz (160 meters) through 1.2 GHz, and in all modes, including SSB, CW, RTTY, AMTOR, Packet, FM, ATV, and SSTV. The station's call sign is VE7EXPO. Operation is from 10 am to 10 pm local time daily; it should provide an interesting introduction to amateur radio for many of the more than 13 million visitors expected at Expo 86. A computer system that permits the public to ask questions about amateur radio is also featured.

Station VE7EXPO is manned entirely by volunteer amateur operators, providing not only a massive public-relations opportunity for ham radio, but an information center for many non-local amateurs. Local repeaters on 146.94, 224.30, and 443.525 MHz are monitored. Visiting hams who wish to take part as a group or to arrange contacts for special events may reach the VE7EXPO Amateur Radio Society at 202-13640 67 Ave., Surrey, BC, Canada V3W 6X5. R-E

Unique electronic device can curb perspiration

A device that will keep people with heavy sweating problems of the hands, feet, or underarms dry for periods of up to six weeks has been announced by General Med-

ical Co. (1935 Armacost Ave., Los Angeles, CA 90025).

Excess perspiration has long been an awkward social problem. In electronics and other high-technology industries it can also cause professional problems—in some industries people who perspire heavily are being banned from many production positions because they present a possible source of contamination.

The device, called the *Drionic*, consists of two metal plates that are placed close together but are insulated from each other. A mild electric current passes from one plate into the skin and from the skin into the other plate. The current tends to inhibit the action of the sweat glands in the skin, essentially plugging them for periods of up to six weeks.

The *Drionic* is available by prescription only.



NO SWEAT with *Drionics* from General Medical. That device is claimed to stop perspiration for up to six weeks.

VIDEO NEWS



DAVID LACHENBRUCH
CONTRIBUTING EDITOR

• **Upsurge for VHS-C.** It now appears that virtually the entire VHS group will embrace VHS-C, the miniature version of the the VHS standard, as a weapon against the 8mm-video system offered by Sony, Kodak, and others. To date, Matsushita (Panasonic and Quasar), Hitachi, Mitsubishi, Sharp, Toshiba, and Zenith, as well as JVC, the developer of both VHS and VHS-C, are backing the format. The action of that group of Japanese manufacturers came in response to pressure from JVC, which warned that adoption of the 8mm format by videocassette recorder manufacturers would deal a serious blow to the dominant VHS system.

Sony insists 8mm is the format of the future, and that it will eventually replace both VHS and Beta. The VHS group, on the other hand, sees 8mm as a threat only in the combination camera-recorder, or camcorder, field. The new, super-miniaturized VHS-C camcorder with the added extended play mode (one hour per cassette) is their answer.

It will be some time before we know which side is correct. Indeed, the industry continues to wonder just how big the camcorder market really is. The VCR came to prominence as the result of its time-shift and movie-showing capabilities. Its viability as a home-photography medium is yet to be proved in the marketplace.

• **Movies for 8mm.** If 8mm video is indeed the all-purpose videocassette medium of the future, as Sony insists, it will need pre-recorded material. Sony and Eastman Kodak have long been wooing the movie people to put their products on 8mm, and finally they have met with some success. Sony has reached agreement with Paramount Pictures and Kodak with Embassy Home Entertainment to release some of their more popular films on 8mm, to retail at about \$30.00.

Although initially there will be relatively few films available, both film makers have agreed to release more movies in the future, and both Sony and Kodak are using these new agreements as pump-primers to lure more programmers into the 8mm medium.

• **Happy VCR owners.** In the 10 short years it's been on sale, the VCR has seemingly become a household necessity. A new survey by the Electronics Industry Association (EIA) asked 2,749 VCR-owning families what they'd do if their recorders should fail "beyond repair." About 95% said they'd buy another.

Based on that response, and the responsibilities to its other questions, the survey indicated that a large replacement and second-VCR market is developing. Some 37% of all households surveyed said they planned to buy VCR's in 1986; that included 41% of non-owners and 32% of those who currently own VCR's. Some 17% of VCR owners bought a second machine in 1985. In a typical week the average household uses its VCR for 8.1 hours of recording and 9.3 hours of playback. (The playback of purchased or rental prerecorded videotape accounted for the discrepancy between those two figures.)

About 7% of VCR's receive service in the first year after purchase, 43% within the first 5 years—but 39% of all repairs were made without charge to the owner, presumably because the units were under warranty.

Of the VCR's requiring service, head cleaning was the most common reason (cited by 32% of VCR owners), followed by repair of the rewind mechanism (by 15%), head replacement (by 11%) and audio repair (by 9%).

• **Stereo-TV survey.** Another survey, this one by the National Association of Broadcasters, queried 200 TV stations that are broadcasting with multichannel TV sound. It found that 74% were broadcasting network stereo programs, averaging nine hours weekly; 63.5% were broadcasting syndicated stereo programming, averaging 5.1 hours; and 47% were putting on their own local stereo programming, averaging 5.6 hours.

On the other hand, the survey found that only 8.5% of stations were making use of the Secondary Audio Program (SAP), although another 16.5% said they planned to start using SAP "in the near future." The most common application of SAP was for bilingual programming.

What Pomona knows about cable assemblies would fill a book.

At Pomona Electronics we have assigned top priorities to the design and development of patch cords and cable assemblies. We know how important these quality products are to our customers.

Simply stated, our philosophy is to do whatever has to be done to make more and better interconnecting electronic test products. So we can make the professional life of the design engineer a little easier.

In our 1986 General Catalog you'll find almost 250 different variations of patch cords and cable assemblies with an almost endless variety of connector combinations, lengths and cable or wire characteristics. Cable breakouts are included too. Of course, new items have been added again this year.

Here's how to get your copy of our 1986 General Catalog: Just circle the reader service number below; call us at (714) 623-3463; write us at ITT Pomona Electronics, a division of ITT Corporation, 1500 East Ninth Street, P.O. Box 2767, Pomona, California 91769.

Our products are available through your favorite electronics parts distributor.



ITT
Pomona Electronics
CIRCLE 101 ON FREE INFORMATION CARD

ASK R-E

WRITE TO:

ASK R-E
Radio-Electronics
500-B Bi-County Blvd.
Farmingdale, NY 11735

COMPOSITE VIDEO FROM RGB INPUT

Is there a simple circuit for deriving a composite-video signal from a computer's RGB output? I'd like to feed the composite signal into a VCR.—R. W. L., Pittsburgh, PA.

The MC1377 color-television RGB to PAL/NTSC encoder IC from Motorola should give you a good start. It generates a composite TV signal from baseband red, blue, green, and sync inputs. It is ideal for encoding signals from color cameras and graphics generators. It appears that all you must do is provide a source of composite-sync signals that will be combined with the encoded video to produce the composite-video output.

I haven't located an IC to generate the composite sync; perhaps a reader can help. In the meantime, you might experiment with using an old TV set as a sync generator. Some of the older tube-type models had excellent sync separators. Horizontal and vertical sync signals stripped from an off-the-air TV signal should be more than stable enough for your VCR.

For a copy of the MC1377 data sheet and information on the availability of the IC, write to Motorola Semiconductor Products, P.O. Box 20912, Phoenix, AZ 85036.

BALUN FOR TV RHOMBIC

I am using a rhombic antenna to receive two TV stations. Reception is good but I believe that it will improve if I improve the match between the antenna and my 300-ohm transmission line. How do you make a balun that matches a 600-ohm antenna to a 300-ohm line?—T. P. L., Sturgis, Saskatchewan.

The balun will be a quarter-wave

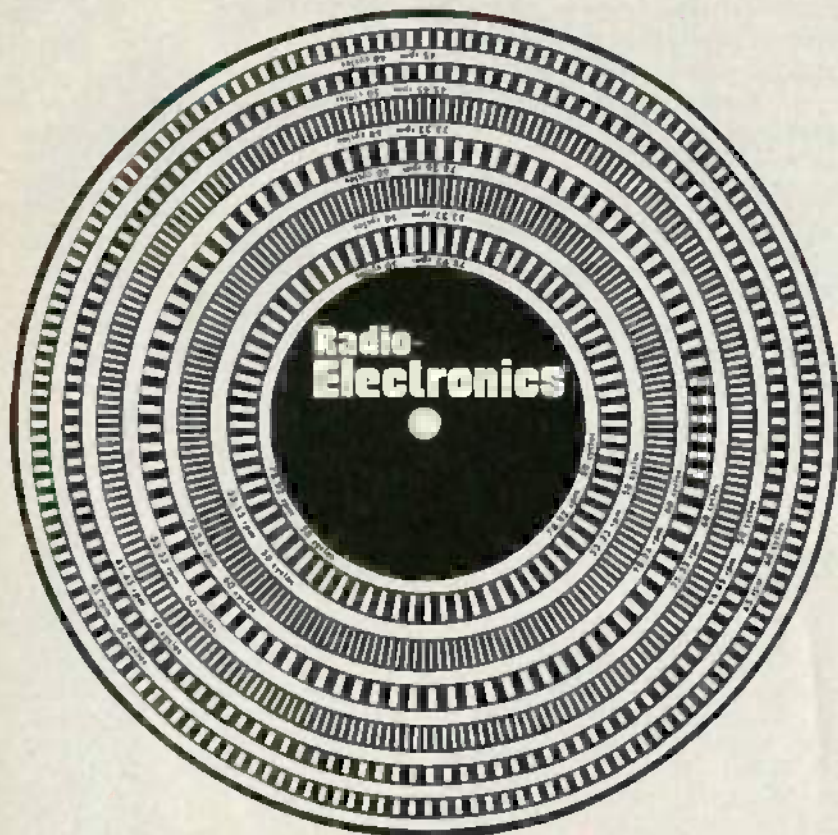

FIG. 1

SIMPLE STROBOSCOPE

Please print the circuit details for a simple hand-held strobe light that can be used for checking the speed of a turntable. Dealers in my area don't stock a useful strobe.—R. J. E., Delta, OH.

Here's a stroboscope you can throw together in a few minutes. You can use a commercial neon-lamp tester or you can assemble your own by wiring a 220K resistor in series with an NE-2 lamp and a 117-volt line cord. For convenience and safety, assemble the components in a plastic tube; the barrel of an old felt-tip or ball-point pen will serve nicely.

If your turntable has

stroboscopic markings around its perimeter, you're all set. Otherwise, cut out the disc shown in Fig. 1 and mount it on a piece of stiff cardboard. Our disc has markings for RPM's of 33½, 45, and 78, and it can be used in both the U. S. and Europe, because it contains separate sets of bands for both 50 and 60 Hz.

Apply power to your turntable and hold the neon-tester near the band of interest. The markings on the disc should appear to be stationary, or very nearly so. Use your turntable's speed control to adjust speed so that the markings appear perfectly still. That's all there is to it!

Electricity and water don't mix. At least not in our Heavy Duty Digital Multimeters. Because these Ops Proof™ instruments are protected by a system of seals to ensure contamination-free dependability in even the cruddiest conditions.

Other abuse-proof features include the best mechanical protection ever built into a precision Digital Multimeter. In fact, every one of our Ops Proof multimeters will survive a drop from ten feet onto a concrete surface!

All the Heavy Duty series meters measure up to 1000 volts AC and 1500 volts DC, with full overload protection to those maximum voltages even on the lowest range settings. Overload circuitry also provides transient protection to 6KV on all voltage ranges and up to 600 volts on all resistance ranges.

We also invented a unique, long-life rotary switch for our Digital Multimeters. You can actually feel the difference just by

rotating the function selector knob.

You'll find these features in a full line of Heavy Duty DMMs that offer a 4½ digit readout, 0.05% VDC accuracy, a 10-amp current range, a 2000-hour battery life, diode test, true RMS and temperature measurement. All this and a no-questions, one-year warranty.

You'll want to try one out, of course, so drop into your nearest electronics distributor and drop one.

Our lips are sealed.



section of transmission line having a characteristic impedance equal to the square root of the product of the two impedances it is to match. In other words,

$$Z_B = \sqrt{Z_A \times Z_L}$$

where Z_B is the impedance of the balun, Z_A is the impedance of the antenna, and Z_L is the impedance of the line to the TV set. So:

$$Z_B = \sqrt{300 \times 600} = 425\Omega$$

The characteristic impedance (Z_O) of an air-insulated (open-wire) parallel-conductor line is:

$$Z_O = 276 \log (b \div a)$$

where b is the center-to-center spacing between the conductors and a is the radius of the conductors. Also, b and a must be measured in the same units.

To solve the equation, you'll need a wire table and a table of common logarithms. For your specific case, you can use 14-gauge wires spaced 1¼ inch apart, or 12-gauge wires spaced 1½ inch apart, 10-gauge wire spaced 2 inches apart, or ¼-inch tubing spaced 4½ inches center-to-center.

The balun should be one-quarter wavelength long at the desired frequency. Allowing for a velocity factor of 0.90, the quarter-wave section will be $2656/f$ inches, where f is the center frequency of the desired channel (in megahertz). The section will be approximately 41 inches for a low-band TV rhombic, 14.25 inches for a high-band rhombic, and 4.25 inches for a UHF rhombic.

If you want to build either a single- or a multi-channel balun, Fig. 3-b and Fig. 3-c should give you a few ideas. You'll have to use spacers of some sort to hold the conductors apart. The spacers can be cut from any suitable insulating material such as fiberglass, polystyrene sheets, rods, or tubing, bamboo rods, or wooden dowels that have been waterproofed with several coats of shellac or polyurethane varnish. The wires can be passed through drilled holes or laid in slots cut in the spacers.

The size, weight, and strength of the spacers, as well as the wire diameter are interrelated. Spacers that are too heavy can stretch the wires or cause them to break in bad weather. Similarly, large diameter conductors will soon snap spacers that are too light. One good combination is to use 14-gauge wire for the conductors and spacers made from ¼-inch dowels or plastic rods.

For a single-frequency balun, the distance between spacers is not critical, but there should be enough spacers so that the wires do not change position as the transmission line sways in the wind.

A multi-frequency balun is more difficult to build. The space between the wires will be difficult to hold unless you put spacers about an inch or so apart. Even so, it may be hard to hold to an exponential curve.

So, you may do as one transmission-line maker did in the early days when TV stations were few and far between, and most TV viewers were DX'ers. Take a sheet of acrylic plastic or polystyrene that is about ¼ inch thick, 6 inches wide and 55 inches long. Lay out the exponential curves and anchor the wires along them with a heavy application of plastic cement. R-E

What is the quickest, most cost-efficient way to service TVs, VCRs and home computers?

Sams PHOTOFACT and COMPUTERFACTS

For 40 years, Sams PHOTOFACT has been the preferred source for television service data. Today, Sams is the preferred source for VCR, computer, and computer peripheral service data. Why? Because Sams service data is accurate, reliable, provided in a consistent format, and available at a very reasonable price. With more than 150,000 different models, you can depend on Sams to have the service data you need.

Sams works from actual production models, disassembling each unit and testing each board. Every component location, every circuit track, and every waveform is checked and rechecked. Sams exclusive time-saving features let you do repairs quickly, without guessing:



- **CAD-Generated Schematics** — our computer-aided design system gives you clear, readable data in Sams Standard Notation format.
- **GridTrace™** — a "roadmap" grid in our circuit board photos for easy parts location and identification.
- **CircuitTrace®** — helps to pinpoint circuit location saving tracking time.
- **Troubleshooting Tips** — solve problems without trial and error.
- **Easy-Read Waveforms** — clear reproductions of actual waveform photos show you exactly what your test waveform should look like.
- **Replacement Parts Cross References** — save costly and time-consuming trial and error.

To order call

800-428-SAMS

Ask for operator 831

In Indiana call 317-298-5566

At \$9.95 for PHOTOFACT and \$19.95 or \$39.95 for COMPUTERFACTS you receive all the data needed to service your equipment.

To order the service data you need call 800-428-SAMS or visit your local electronic distributor or computer store.

For a complete listing of Sams PHOTOFACT and COMPUTERFACTS coverage send \$3.00 (Product #22505) and you'll receive a FREE book catalog listing Sams electronic and computer books.

Name _____

Company _____

Address _____

City _____

State _____ Zip _____

Daytime Telephone No. _____

Bill my credit Card VISA MC AE

Account No. _____ Exp. Date _____

Signature (required) _____

Check or money order enclosed. Make checks payable to Howard W. Sams & Co. Mail this form with payment to Howard W. Sams & Co., Dept. DM • 4300 West 62nd Street • Indianapolis, IN 46268

DM831

Here's just a few of the brands covered:

PHOTOFACT

Curtis-Mathes®

Magnavox®

Panasonic®

RCA®

Sears®

Sony®

Zenith®

COMPUTERFACTS

Amdek®

Apple®

Commodore™

Epson®

IBM®

Okidata®

Radio Shack®

SAMS



Your guide to everything that's new in electronics, computers and technical education. Over 400 items. Discover fascinating kits to build, enjoy and learn with, as well as assembled high tech products for home, business and hobby.

Get our famous High Tech Catalog

FREE

Heathkit[®]
Heath
Company

A subsidiary of Zenith Electronics Corporation
CIRCLE 66 ON FREE INFORMATION CARD

Heath Company
Dept. 020-444
Benton Harbor, Michigan 49022

MAIL COUPON TODAY and receive the latest issue of the Heathkit Catalog free of charge

Name _____

Address _____

City _____ State _____

CL-783DR3 Zip _____

COMB

Authorized Liquidator

INTERSTATE™ BY FDX RADAR DETECTOR



FACTORY
NEW!
FIRST
QUALITY!

Super Sensitive! Alerts you to radar up to 5 miles away!

- **SENSITIVE!** Proven in lab tests to be as good or better than Escort, Cobra and Whistler models costing up to twice as much!
- **COMPACT!** Just 3¼" X 1½" X 3¼".
- **HIGHLY SENSITIVE!** Superheterodyne circuitry.
- **MORE RANGE!** Detects fringe signals and hand-held pulse radar.
- **HIGHLY SELECTIVE!** False alarms are reduced by narrower band width, video signal processing and built-in dielectric lens.
- **DOUBLE ALARMS!** When radar is detected, it triggers a red LED light and a buzzer.
- **LOUD ALARM!** Can be heard above traffic noise.
- **3-WAY SWITCH!** For off, city, long range highway use.
- **CONVENIENT!** Plugs into your cigarette lighter.

One-Year Limited Factory Warranty.

(Offer void where prohibited by law.)

Mfr. List \$239.95 **\$119**

Liquidation Price . . .
Item M-1373-2999-001 Ship. handling: \$3.75

Credit card customers can order by phone,
24 hours a day,
7 days a week.



Toll-Free: 1-800-328-0609

Your check is welcome!
No delays in orders paid by check.

Sales outside the 48 contiguous states are subject to special conditions. Please call or write to inquire.

C.O.M.B. Direct Marketing Corp. (Item M-1373)
14405 28th Ave. N./Minneapolis, MN 55441-3397

Send Radar Detector(s) Item M-1373-2999-001 at \$119 each plus \$3.75 each for shipping, handling. (Minnesota residents add 6% sales tax. Sorry, no C.O.D. orders.)

My check or money order is enclosed (No delays in processing orders paid by check, thanks to TeleCheck.)
Charge VISA® MasterCard® American Express®

Appl. No. _____ Exp. / /

PLEASE PRINT CLEARLY

Name _____

Address _____

City _____

State _____ ZIP _____

Phone (____) _____

Sign Here _____

COMB Direct Marketing Corp.

Authorized Liquidator
14605 28th Avenue North
Minneapolis, Minnesota 55441-3397

LETTERS

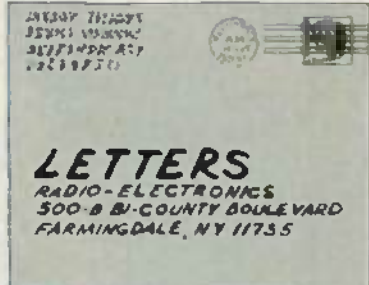

TESLA SYMPOSIUM

This is to inform your readers that the 1986 International Tesla Symposium will commemorate the 100th anniversary of Nikola Tesla's first U. S. patent; the patent was for an electric arc lamp. The symposium will provide a forum for the review and exchange of ideas pertaining to the many concepts that Tesla developed and patented. Topics to be discussed include: Tesla's life and times; electromagnetic theory; the tesla coil and high-voltage power-supply design; electric power generation and transmission; radio and telecommunications; lightning, weather and geophysical phenomena; ball lightning; nuclear fusion containment; Tesla turbine technology; curl-free magnetic vector potential (the ability to penetrate Faraday-shielded systems; see "Gravity Waves?" in the April 1986 issue of Radio-Electronics for more information); Ampere-Neumann theory of conduction in metals; aerospace and defense applications; social implications of Tesla technology.

The symposium will be held from July 30 to August 3, 1986 at Colorado College, Colorado Springs, CO. For additional information contact The International Tesla Society, 330-A West Uintah Street, Suite 215, Colorado Springs, CO 80905-1095.

TOBY GROTZ, CHAIRMAN
1986 International Tesla Symposium

GRAVITY WAVES

This letter is in response to the article, "All About Gravity Waves," by Gregory Hodowanec, in the April 1986 Radio-Electronics. I read that article with interest. Careful

scrutiny and further research has led me to some very basic disagreements with the author.

If the cosmology described is indeed a true representation of reality, then several questions arise:

1. If the edge of the universe is a perfect reflector, and if the sum total of the background flux in the universe gives rise to the background microwave temperature of 3° K, then, because of the multitude of fusion and fission reactions in the universe at all times, the background temperature should be increasing. No evidence of that rise in temperature can be proven at this time.

2. Which type of monopole does the circuit described in the article measure? There are two known types of monopoles: positive and negative. Due to the alignment of C1 in the input, the circuit detects positive monopoles.

The basic flaw in Mr. Hodowanec's theory is that, because he has chosen an inverting circuit, the output is 180 degrees out of phase with the input. He is, therefore, actually measuring "anti-rhythms."

After building the device and performing rigid tests, the data was examined by several colleagues and me. The data was as described in the article. However, when two such circuits were built and placed some distance apart, and the two outputs were examined on a dual-trace oscilloscope, the modulating waveforms were not the same. That indicates that Hodowanec's measurements were off, and that the monopole gravitational waves are in a much smaller grid pattern than he described.

Those findings, along with the work done in Rohnert Park and



SCOPE 3½ DIGIT LCD MINI-METER WITH THE MAXI-SPECS

Small enough to fit in your shirt pocket

\$29.95
ONLY Model DVM-630

Model CC-30 Deluxe
Zippered Carrying Case \$4.50

- 0.5% DC accuracy
- 6 Functions, 19 Ranges
 - DC Voltage, 0.1 mV to 1000 V
 - DC Current, 0.1 uA to 2A
 - Resistance, 0.1 ohm to 2 M ohm
 - Diode Test
 - Battery Test
- Measures approx. 5 x 2¼ x ¼ In.
- 300 hour battery life
- Automatic zero adjust
- Low battery indication
- Test leads included



SCOPE HAND-HELD DIGITAL CAPACITANCE and MULTIMETERS

- 0.5% DC Accuracy
- Highest Quality
- Highest Performance
- Lowest Prices



Model DCM-602
\$69.95

3½ Digit Capacitance Meter
8 ranges with full scale values to 2000 uF
FEATURES • Broad test range - 1 pF to 2000 uF • LSI circuit provides high reliability and durability • Lower power consumption • Crystal time base
• Protected from charged capacitors
• Frequency range - 800 Hz to 8 Hz

Model DVM-634
\$48.75
7 functions, 32 ranges.
Transistor measurement
Included.

Model DVM-638
\$79.95
11 functions, 38 ranges.
Includes logic level detector,
audible visual continuity,
capacitance and conductance
measurement.

Model DVM-636
\$62.75
8 functions, 37 ranges.
Capacitance measurement
included.

3½ Digital Multimeters
FEATURES • DC Voltage 100 uV - 1000 V • AC Voltage 100 uV - 750 V • AC/DC Current 200 uA - 10 Amps • Resistance 20 Megohms • Capacitance (DVM 636/638) 1 pF - 20 uF
• Overload Protection • Auto-decimal LCD readout • Polarity indication • 300 hour battery life with 9V transistor battery • Low battery indication

ASK FOR FREE CATALOG.
Money orders, checks accepted. C.O.D.'s require 25% deposit.

Fordham

260 Motor Parkway, Hauppauge, NY 11788



Toll Free
800-645-9518
In NY State 800-832-1446

Service & Shipping Charge Schedule Continental U.S.A.	
FOR ORDERS	ADD
\$25-\$100	\$4.50
\$101-\$250	\$6.00
\$251-\$500	\$8.00
\$501-\$750	\$10.50
\$751-\$1,000	\$12.50
\$1,001-\$1,500	\$16.50
\$1,501-\$2,000	\$20.00
\$2,001 and up	\$25.00

AUGUST 1986

The NutriWheat™ Diet Program: A Rational and Extremely Effective Program for Weight Loss and Management.



NutriWheat is 100% Natural High Protein and Fiber Food developed by one of 4 Famous Food Research Technologists chosen by NASA to develop Food for the Space Program.

The **NutriWheat** Diet Program Succeeds For Several Reasons:

- It's easy **not to cheat**. Because it's made with expanded high-fiber whole wheat, it will fill you up without filling you out. Hunger won't be a constant temptation.
- You will not stop eating, but will start eating in a smart, balanced way — a way that will help you arrive at your perfect weight and **stay there forever**.
- The program will satisfy your basic nutritional, physical and appetite-related psychological needs, including the need for variety, for biting and crunching — even for snacking. **NutriWheat** has been called the "ultimate munchy" — a crunchy, tasty snack food that's actually good for you!
- Not only is **NutriWheat** wholesome — it's delicious! It's low in sodium, contains no sugar, and comes in six flavors: apple cinnamon, sour cream and onion, original (malt), chocolate, peanut, and barbeque.
- The program is natural and safe — you can stay on it as long as it takes to meet your weight loss goals, and then continue to eat **NutriWheat** as a wholesome lifetime snack food.
- Spicer's MicroBalance Supplement was uniquely formulated to contain an optimal balance of all essential micro-nutrients makes this program nutritionally complete.
- **The Diet:** The program was designed for the dieter to set a weight reduction goal, then progress toward it at a safe pace which is in tune with his or her size, metabolism and nutritional requirements. When you're ready to start, all you do is replace two of your three meals with one 1 oz. pack of **NutriWheat**. Your third meal should be selected from the suggested meal plan provided, all of which contains approximately 800 calories. Depending on your body size and metabolic rate, it may be advisable to take more or even fewer **NutriWheat** packs than the daily suggested two. A 300 lb. ex-linebacker will obviously require more **NutriWheat** than a slightly overweight ballerina. By all means, if you become hungry, have another pack.

(It is important that anyone wishing to start a diet program consult his or her physician.)



Who Developed NutriWheat? Dr. Arnold Spicer a world renowned research scientist, educator, author, lecturer and one of the most esteemed inventors of our time. His cause is to improve our way of life with better nutrition, solutions for obesity, and solutions for common health threats.

His long list of achievements include: development of artificial blood plasma, artificial glycerine and a quinine substitute. He was also a major contributor to the NASA food for space program, and patented the important process of converting starch to protein in order to fight malnutrition in the third world.

NutriWheat represents the achievement of Dr. Spicer's goal to return to basic, time-tested nutritional truths and marry man's physiology to the finest food available today.

SEND ORDER TO: **bp** 260 Motor Parkway, Hauppauge, NY 11788

Please send me _____ Case(s) of NutriWheat (2 week supply 34 packagea) at \$49.95 per case.
Add \$4.50 shipping charge for each case. Total _____

Please send me _____ Bottle(a) of MicroBalance Supplement (1 month supply) at \$19.95 ea.
Add \$1.00 shipping charge for each bottle. Total _____

My Check or Money Order Is Enclosed.

Charge My Credit Card Visa MasterCard Amex

Card # _____

Signature _____ Exp. Date _____

Telephone: (_____) _____

Name _____

Address _____

City _____ State _____ Zip _____

Phone Orders Call Toll FREE out of state **800-645-9152**
NYS Toll FREE **800-832-1446 ext. 42**



STUN GUN



EQUALIZER

- The ultimate non-lethal defense weapon.
- In five seconds can immobilize your attacker, even through heavy clothing.
- Discharges over forty thousand volts of electricity from a nine volt nickel-cadmium battery.
- \$39.95, Mass 5% sales tax, \$3.00 shipping and handling.

1-800-522-2636
FOR ORDERS ONLY
617-871-5611
FOR INFORMATION

Cameo Enterprises, Inc.
P.O. Box 63, Accord, MA 02018

CIRCLE 89 ON FREE INFORMATION CARD

Santa Rosa by Professors Frank Nance, Brian Ekias, Jay Johnson, and John Macri support the hypothesis that, in order to prove Hodowanec's theories, not only must the logical complement be proven, but the entire concept of 1/f noise must be disproven without any doubt.

Further thought leads to the idea that gravitational waves can be transmitted and that they can be modulated to produce intelligent signals instantaneously at all places in the universe at any time. That would solve many of today's communications problems and would open up an area of intergalactic monopole gravitational-wave propagation theory. Among the questions to be discussed are: what would the antennas look like? What kind of attenuation takes place at various distances from the antenna? The antenna, of course, would be called a "Monopolic Rhythmic Gravitational-Wave Transducer."

I hope that my research has shed some light on the weighty topic of gravity waves. Remember that the difference between brilliant and crazy is often no more than the Nobel Prize.

JIM STERN
Petaluma, CA

While rhythmic cosmology does not deny that the microwave background temperature of the universe could increase (or decrease) in time, it should be remembered that in terms of rhythmonics that radiation processes in the universe are 1) reversible to some extent, in that radiation could create new particles and thus "freeze" some radiant energy back into mass, and 2) electromagnetic energy "degrades" to a cooler temperature in the process of propagating in this universe. Therefore the universe could reach an equilibrium state and remain there for eons.

Simple audio stereo-type tests, using two detectors (operating under similar electrical conditions) will demonstrate a large measure of correlation between the detectors. Since the detectors have a fine "pencil-width beam response," they can detect other effects when widely spaced. A

continued on page 20

Learn micro-processing with the new MICRO-PROFESSOR 1P



Students, engineers or technicians—upgrade your micro-processing skills with the new Micro-Professor 1P.

The MPF-1P features:

- extensive software support
- more built-in memory
- improved keyboard
- larger display

Three tutorial guides help cover all capabilities. The ideal training tool! MPF-1P will deliver you into the growing world of micro-processing. Invest now!

Plus—FREE GIFT Only \$199.95

Check this box for FREE Z-80 Microprocessor Programming and Interfacing textbook when you order within 7 days. \$16.95 value. (Includes \$7.50 postage & handling.)

ETRONIX

Dept RE0886
5326 9th Ave. N.E.
Seattle, WA 98105-3617

For immediate action call TOLL FREE:

1-800-426-1044

Full money back guarantee.

Pictured with optional printer



CIRCLE 111 ON FREE INFORMATION CARD

LOW COST PROBES FOR ALL SCOPES



\$43

MODEL SP1000
SWITCHABLE X1-X10
100 MHz

TPI offers equivalents to all makes of probes including modulars, at savings up to fifty percent. TPI probes compensate to all scopes. Slender, flexible cables are easier to handle yet more durable because of their unique center conductor. Performance is guaranteed.

FOR FAST RESPONSE CALL

800-368-5719

In Calif. 800-643-8382

TEST PROBES, INC.



Your Probe Specialists
CO-LINE U.S. SALES & STOCKING SOURCE

P.O. Box 2113, LA JOLLA, CALIFORNIA 92038 (619) 459-4197

CIRCLE 123 ON FREE INFORMATION CARD

AUGUST 1986

15

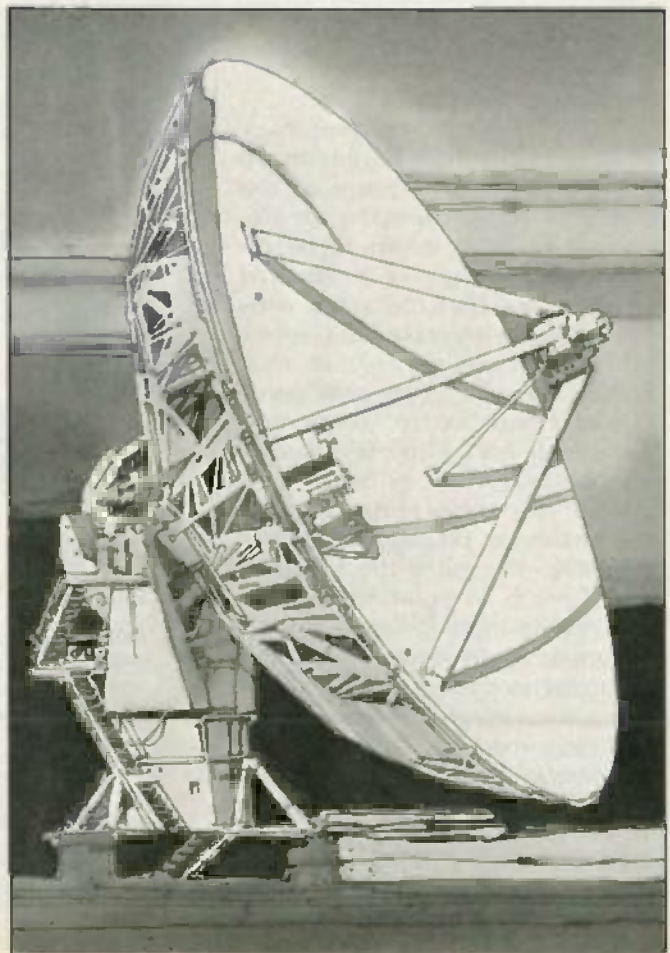
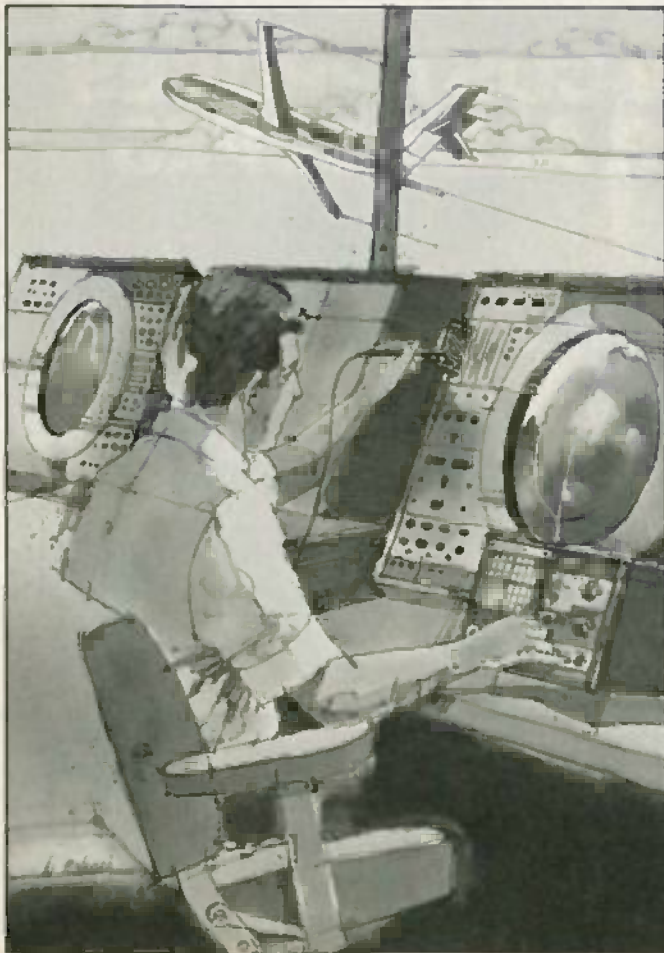
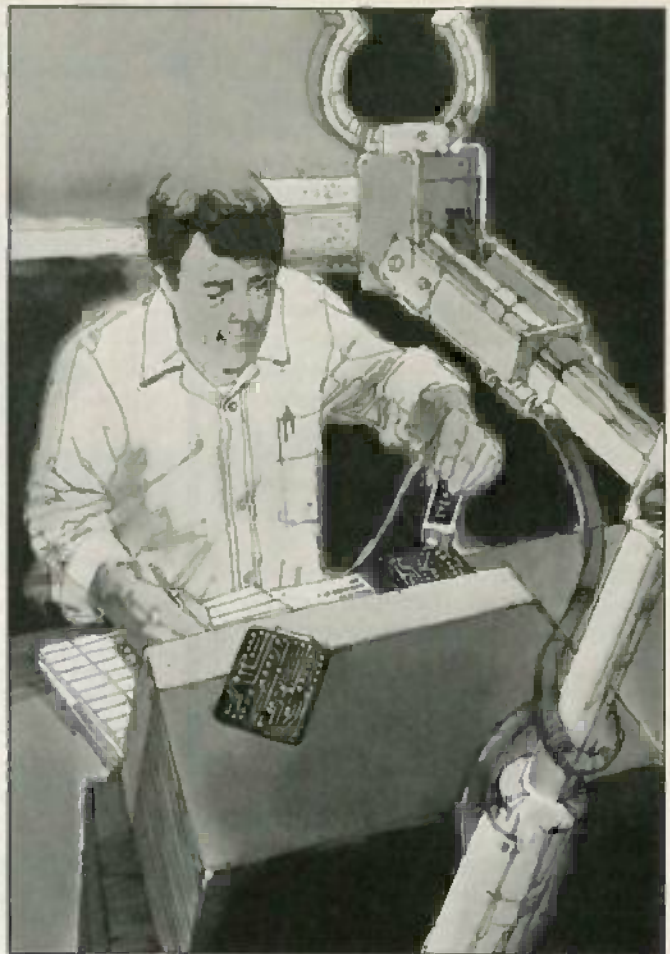

CIE MAKES THE WORLD OF ELECTRONICS YOURS.

Today's world is the world of electronics. To be part of it, you need the right kind of training, the kind you get from Cleveland Institute of Electronics, the kind that can take you to a fast growing career in business, aerospace, medicine, science, government, communications, and more.

Specialized training.

You learn best from a specialist, and that's CIE. We're the leader in teaching electronics through independent study, we teach only electronics and we've been doing it for over 50 years. You can put that experience to work for you just like more than 25,000 CIE students are currently doing all around the world.

Practical training.

You learn best with practical training, so CIE's Auto-Programmed® lessons are designed to take you step-by-step, principle-by-principle. You also get valuable hands-on experience at every stage with sophisticated electronics tools CIE-designed for teaching. Our 4K RAM Microprocessor Training Laboratory, for example, trains you to work with a broad range of computers in a way that working with a single, stock computer simply can't.

Personalized training.

You learn best with flexible training, so we let you choose from a broad range of courses. You start

with what you know, a little or a lot, and you go wherever you want, as far as you want. With CIE, you can even earn your Associate in Applied Science Degree in Electronics Engineering Technology. Of course, you set your own pace, and, if you ever have questions or problems, our instructors are only a toll-free phone call away.

The first step is yours.

To find out more, mail in the coupon below. Or, if you prefer, call toll-free 1-800-321-2155 (in Ohio, 1-800-523-9109). We'll send a copy of CIE's school catalog and a complete package of enrollment information. For your convenience, we'll try to have a representative contact you to answer your questions.

CIE Cleveland Institute of Electronics 1776 East 17th St., Cleveland, Ohio 44114

YES! I want to get started. Send me my CIE school catalog including details about the Associate Degree Program. I am most interested in:

- | | |
|--|---|
| <input type="checkbox"/> computer repair | <input type="checkbox"/> television/high fidelity service |
| <input type="checkbox"/> telecommunications | <input type="checkbox"/> medical electronics |
| <input type="checkbox"/> robotics/automation | <input type="checkbox"/> broadcast engineering |
| <input type="checkbox"/> other _____ | |

Print Name _____

Address _____ Apt. _____

City _____ State _____ Zip _____

Age _____ Area Code-Phone No. _____

Check box for G.I. Bulletin on Educational Benefits

- Veteran Active Duty

MAIL TODAY!

OR CALL TOLL FREE
1-800-321-2155
(In Ohio, 1-800-523-9109)

AUGUST 1986

RE-42

19

Special
Sale

MEGURO
MADE IN JAPAN

3½-DIGIT AUTORANGING MULTIMETERS

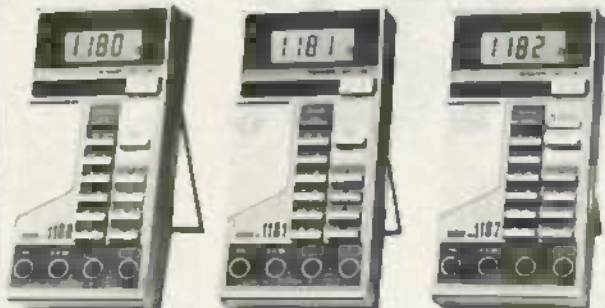

MDM-1180

~~\$495~~
\$395

MDM-1181

~~\$95~~
\$65

MDM-1182

~~\$95~~
\$53

FEATURES:

- Automatic and Manual Ranging Selectable (except current measure.)
 - Large and High Contrast LCD
 - Custom and Power Saving ICs:
500 hours on just two AA-Batteries
 - Accuracy (DC Volt): MDM-1181 0.1%,
MDM-1182 0.25%, MDM-1180 0.7%
 - Data Hold Function (MDM-1182 only)
 - 9 Measurement Functions
 - 2 AA-size Batteries, Safety
Measurement Leads and Fuse Included
 - ONE YEAR WARRANTY
 - QUANTITY LIMITED
- PLEASE ADD FOR SHIPPING AND INSURANCE
- \$39.00-\$250.00: \$4.50/\$251.00-\$600.00: \$6.50
\$601.00-\$750.00: \$8.50/\$751.00-\$1,000.00: \$12.50
\$1,000.00 and more: \$15.00
- WE ACCEPT ONLY MONEY ORDERS OR CHECKS TO SAVE YOUR COST.
- PLEASE ADD 6.5% FOR TAX (CA ONLY)

HI-SHURE CORP.
TOLL FREE 1-800-222-7798
1050 E. DOMINGUEZ ST.
CARSON, CA 90746
(213) 637-1863

REB

more definitive correlation experiment can be performed with two detectors, A and B and a CMOS switch. The switch is used such that detector A is switched on by a pulse from detector B and vice versa. The outputs are fed to a difference amplifier. Under such conditions, full correlation between the 1/f signals would result in no output from the difference detector. In practice, somewhat less than full correlation is seen due to the extreme resolution of the detectors, and the highly random nature of the gravity waves.

Gravitational signal communications are closer than you think. Feasibility on a laboratory scale has already been demonstrated by the author.—Gregory Hodowanec

EGO BUSTER

The April 1986 issue of Radio-Electronics was an ego buster. I think I was had three times. Always liking physics, I read the article about gravity waves with great interest, because the ideas discussed there seemed in line with rumors about transmitting signals with curved transmission patterns, and other rumors about high-voltage capacitors (with electronic bleeder circuits) that re-charge to a high voltage after being discharged. The explanation of the latter phenomenon is dielectric absorption (DA), true cap leakage, and the effect that the sea of 60-Hz electromagnetic waves we live in has on the plates of the capacitor.

The article about co-photon absorption at first had me until I remembered my blow-up-the-universe theory, which states that if light has infinite mass, then if you could stop light dead in its tracks, you could release infinite energy. One could point to black holes, but to learn the history of astronomy you see that it has been a comedy of errors as formulae were developed to describe the motions of the stars and the planets.

Our universe is amazing and I believe that the universe has a medium faster than light.

Thinking about gravity was interesting. Force = Mass × Acceleration. $P = I \times E$, $P = I^2 R$, $E = MC^2$. It's truly amazing.

W. WEST
Minneapolis, MN

Radio-Electronics mini-ADS

103 PROJECTS FOR ELECTRONICS EXPERIMENTERS



103 PROJECTS FOR ELECTRONICS EXPERIMENTERS. Soft cover; 308 pages of practical, proven plans for the electronics hobbyist...circuits, converters, amplifiers, synthesizers, optoelectronics, power supplies and more. Written and designed by Forrest M. Mims, III. 12491 \$11.50 plus \$1 postage in USA. ELECTRONIC TECHNOLOGY TODAY INC., PO Box 240, Massapequa Park, NY 11762-0240.



THE MODEL WTT-20 IS ONLY THE SIZE OF A DIME, yet transmits both sides of a telephone conversation to any FM radio with crystal clarity. Telephone line powered - never needs a battery! Up to 1/4 mile range. Adjustable from 70-130 MHZ. Complete kit \$29.95 + \$1.50 S+H. Free Shipping on 2 or more! COD add \$4. Call or send VISA, MC, MO. **DECO INDUSTRIES, Box 607, Bedford Hills, NY 10507. (914) 241-2827.**
CIRCLE 127 ON FREE INFORMATION CARD



NEW JERROLD CS 68 CHANNEL CABLE TV CONVERTER with volume control & descrambler loop (Port). Programmable clock turns TV on/off & changes channel. Audio mute kills commercials. Programmable channel scan. Instant channel recall. Automatic fine tuning with manual override. Video & audio outputs. Friendly to all descramblers. Specify output. 1 year warranty. \$139. (Introductory offer) Free delivery. (Dealer Inquiries Invited) 514-739-9328. **CROSLY ELECTRONICS, Box 840, Champlain, N.Y. 12919.**
CIRCLE 198 ON FREE INFORMATION CARD

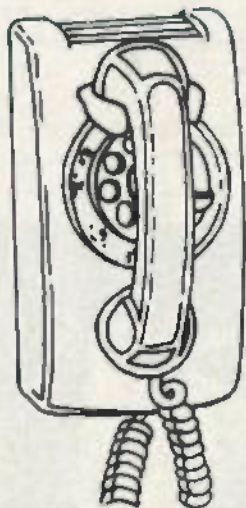

CALL NOW AND RESERVE YOUR SPACE

- 6 x rate \$745.00 per each insertion.
- Reaches 229,044 readers.
- Fast reader service cycle.
- Short lead time for the placement of ads.
- We typeset and layout the ad at no additional charge.

Call 516-293-3000 to reserve space. Ask for Arline Fishman. Limited number of pages available. Mail materials to: mini-ADS, RADIO-ELECTRONICS, 500-B Bi-County Blvd., Farmingdale, NY 11735.



SUBSCRIPTION TV MANUAL This information packed book details the methods used by subscription TV companies to scramble and descramble video signals. Covers the Sinewave, Gated Pulse, SSAVI system, and the methods used by most cable companies. Includes circuit schematics, theory, and trouble shooting hints. Only \$12.95 plus \$2.00 first class P&H. **ELEPHANT ELECTRONICS, INC., Box 41865-R, Phoenix, AZ 85080**
CIRCLE 120 ON FREE INFORMATION CARD



MICROWAVE ANTENNAS \$69.95. Now including shipping and Lifetime warranty. We Repair all types of Downconverters. Cable Converters and equipment available! Jerrold 400 wireless Converter \$72.95 plus shipping. Coax cable, T.V. parts, accessories, connectors, T.V. amplifiers. Write for free catalog or call for prices. **BLUE STAR IND., Dept. 105-RE8-86, 4712 Ave. N, Brooklyn, N.Y. 11234 (718) 338-8318 Ext. 105.**
CIRCLE 85 ON FREE INFORMATION CARD



GATED PULSE DESCRAMBLERS, only \$169. ZENITH SSAVI \$169 each. Reconditioned original equipment for UHF chs. 27,48,51,60, etc. Quantity discounts. Satellite equipment. Surplus TV equipment: N-12, SB-2, SB-3, Hamlin 1200, auto on/off, converters, amplifiers, etc. Catalog \$1. SSAVI modification/troubleshooting handbook \$6.50 ppd. Satisfaction guaranteed. **AIS SATELLITE, INC., P.O. BOX 1226-R, Dublin, PA, 18917. 215-249-9411.**
CIRCLE 81 ON FREE INFORMATION CARD

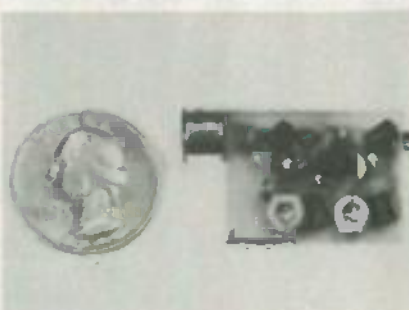

SIMPLY SNAP THE WAT-50 MINIATURE FM TRANSMITTER on top of a 9v battery and hear every sound in an entire house up to 1 mile away! Adjustable from 70-130 MHZ. Use with any FM radio. Complete kit \$29.95 + \$1.50 S+H. Free shipping on 2 or more! COD add \$4. Call or send VISA, MC, MO. **DECO INDUSTRIES, Box 607, Bedford Hills, NY 10507. (914) 241-2827.**
CIRCLE 127 ON FREE INFORMATION CARD

EQUIPMENT REPORTS

B + K Dynascan TTL IC Tester

Test TTL IC's in circuit.

CIRCLE 9 ON FREE INFORMATION CARD



THANKS TO AN EXCITING NEW DEVICE from B + K Dynascan (6460 W. Cortland St., Chicago, IL 60635), the prayers of those that regularly

troubleshoot and service digital equipment have just been answered. That new device is the model 550 TTL IC tester, a com-

pact, easy-to-use hand-held instrument that can also serve as a 20-pin logic monitor. It is capable of testing, in circuit, most 54- and 74-series TTL devices including standard TTL, Schottky, low power Schottky, advanced Schottky, advanced low-power Schottky, high speed, and FAST families. The model 550 has a retail price of \$395.00.

When used as a logic monitor, the unit indicates the logic state of each pin of a TTL IC with 20 or fewer pins. A logic high is indicated by turning on an LED; a logic low is indicated by turning off an

- **Delayed Sweep**

- **20MHZ, Dual Trace**

- **Component Tester**

- **Much More**



\$495

Beckman Industrial

Instrumentation Products Division • Beckman Industrial Corporation • A Subsidiary of Emerson Electric Company
630 Paine Street, Brea, California 92621 • (714) 671-1800 FAX: 810 582-1260 Telex: 168750

CIRCLE 98 ON FREE INFORMATION CARD

Electronics Paperback Books

EVERY BOOK IN THIS AD \$5 OR LESS!

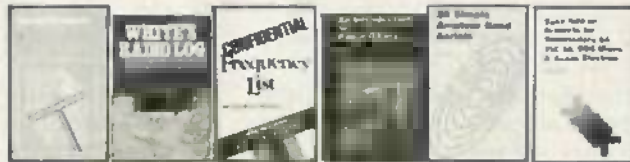

- BP125—25 SIMPLE AMATEUR BAND ANTENNAS.....\$5.00.** All are inexpensive to build, yet perform well. Dipoles, beams, triangle and even a mini rhombic.
- BP 128-20 PROGRAMS FOR THE ZX SPECTRUM & 16K ZX81.....\$5.00.** Programs to run. Programs to have fun with. Even programs that will help you learn to write programs.
- 160—COIL DESIGN & CONSTRUCTION MANUAL.....\$5.00.** How the hobbyist can build RF, IF, audio and power coils, chokes and transformers. Covers AM, FM and TV applications.
- 208—PRACTICAL STEREO & QUADROPHONY HANDBOOK.....\$3.00.** A reference book for all interested in stereo and multichannel sound reproduction.
- 214—AUDIO ENTHUSIAST'S HANDBOOK.....\$3.50.** Explains record/playback curves, stylus compliance, how we evaluate loudness, how compatible is compatible, and more.
- 219—SOLID-STATE NOVELTY PROJECTS.....\$3.50.** Fun projects include the Optomin, a musical instrument that is played by reflecting a light beam with your hand, and many more.
- 222—SOLID STATE SHORT WAVE RECEIVERS FOR BEGINNERS.....\$4.50.** Modern solid-state circuits that will deliver a fairly high level of performance.
- BP126—BASIC & PASCAL IN PARALLEL.....\$4.25.** Takes these two programming languages and develops programs in both languages simultaneously.
- 224—50 CMOS IC PROJECTS.....\$4.50.** Includes sections on multivibrators, amplifiers and oscillators, trigger devices, and special devices.
- 225—A PRACTICAL INTRODUCTION TO DIGITAL IC'S.....\$4.25.** Mainly concerned with TTL devices. Includes several simple projects plus a logic circuit test set and a digital counter timer.
- 226—HOW TO BUILD ADVANCED SHORT WAVE RECEIVERS.....\$5.00.** Full practical construction details of a number of receivers are presented.
- 227—BEGINNERS GUIDE TO BUILDING ELECTRONIC PROJECTS.....\$5.00.** How to tackle the practical side of electronics so you can successfully build electronic projects.
- BP6—ENGINEERS AND MACHINISTS REFERENCE TABLES.....\$2.00.** Screw thread data, drill sizes, circle division, angles, tapers and more.
- 123—FIRST BOOK OF PRACTICAL ELECTRONIC PROJECTS.....\$3.75.** Projects include audio distortion meter, super FET receiver, guitar amplifier, metronome and more.
- BP24—52 PROJECTS USING IC 741.....\$4.00.** Lots of projects built around this one available IC.
- BP32—HOW TO BUILD YOUR OWN METAL & TREASURE LOCATORS.....\$5.00.** Electronic and practical details on the simple and inexpensive construction of heterodyne metal locators.

- BP33—ELECTRONIC CALCULATOR USERS HANDBOOK.....\$5.00.** Invaluable book for all calculator owners. Tells how to get the most out of your calculator.
- BP36—50 CIRCUITS USING GERMANIUM, SILICON & ZENER DIODES.....\$3.75.** A collection of useful circuits you'll want in your library.
- BP37—50 PROJECTS USING RELAYS, SCR'S & TRIACS.....\$5.00.** Build priority indicators, light modulators, warning devices, light dimmers and more.
- BP39—50 FET TRANSISTOR PROJECTS.....\$4.50.** RF amplifiers, test equipment, tuners, receivers, tone controls, etc.
- BP42—SIMPLE LED CIRCUITS.....\$4.25.** A large selection of simple applications for this simple electronic component.
- BP43—HOW TO MAKE WALKIE TALKIES.....\$5.00.** Equipment for low-power hand-held or portable operation.
- BP45—PROJECTS IN OPTOELECTRONICS.....\$5.00.** Includes infra-red detectors, transmitters, modulated light transmission and photographic applications.
- BP48—ELECTRONIC PROJECTS FOR BEGINNERS.....\$5.00.** A wide range of easily completed projects for the beginner. Includes some no-soldering projects.
- BP49—POPULAR ELECTRONIC PROJECTS.....\$4.75.** Radio, audio, household and test equipment projects are all included.
- BP51—ELECTRONIC MUSIC AND CREATIVE TAPE RECORDING.....\$5.00.** Shows how you can make electronic music at home with the simplest and most inexpensive equipment.
- BP56—ELECTRONIC SECURITY DEVICES.....\$5.00.** Includes both simple and more sophisticated burglar alarm circuits using light, infra-red, and ultrasonics.
- BP58—SECOND BOOK OF CMOS IC PROJECTS.....\$4.25.** More circuits showing CMOS applications. Most are of a fairly simple design.
- BP72—A MICROPROCESSOR PRIMER.....\$4.50.** We start by designing a small computer and show how we can overcome its shortcomings.
- BP76—PRACTICAL COMPUTER EXPERIMENTS.....\$4.50.** Construct typical computer circuits using discrete logic to form a basic understanding of how computers function.
- BP91—AN INTRODUCTION TO RADIO DXING.....\$5.00.** How you can tune in on those amateur and commercial broadcasts from around the world in the comfort of your home.
- BP94—ELECTRONIC PROJECTS FOR CARS AND BOATS.....\$5.00.** Fifteen simple projects that you can use with your car or boat. All are designed to operate from 12-volt DC supplies.

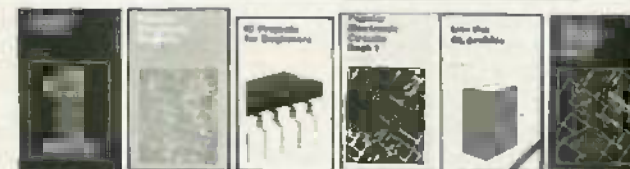

ELECTRONIC TECHNOLOGY TODAY INC.
P.O. Box 240, Massapequa Park, NY 11762-0240

Name _____
Address _____
City _____ State _____ Zip _____

*Canadian Shipping (\$1.50 1st two books 50c ea. additional)

Number of books ordered RE886
Total Price of Books \$ _____
Sales Tax (NY State Residents) \$ _____
*Shipping in U.S. only
(\$1.00 1st two books, 40c ea additional) \$ _____
TOTAL ENCLOSED \$ _____

AUGUST 1986

LED. The advantage of the model 550 over a standard logic probe is that the former can monitor the states of all pins of a device simultaneously and continuously. That, of course makes for much faster troubleshooting.

However, the true power of the unit is as an in-circuit TTL-IC tester. The tests are made by comparing the logic states of the suspect device with those of a known good reference IC. If all of the logic states are the same, a GOOD LED

indicator lights. Otherwise, individual LED indicators light to show the user which pins do not match.

The advantages of being able to test IC's in circuit are obvious. First, the risk of damaging the IC or board during removal or re-installation of a device is eliminated. Second, troubleshooting is made much faster if the time required to remove and re-install each suspected IC is saved.

The unit does not use batteries or an AC adapter. Instead, it draws

power from the circuit in which the IC to be tested is located. Connections are made to +5 volts and ground via permanently attached red and black test clips, respectively. If the power exceeds +5 volts, or the polarity of the connections is reversed, the tester will not turn on.

The advantage of that power set up is, since there are no batteries, there are no dead-battery problems to deal with. However, there is a down side. The tester's current requirements are low, on the order of 125 mA, but there may be instances where that draw exceeds what the circuit-under-test's already-loaded power supply can provide. The only recourse then is to hook a second +5-volt supply in parallel with the first. On a bench, that should present little more than an inconvenience. In the field, it might turn out to be an impossibility. Fortunately, unless you are dealing with a poorly-designed circuit or system, situations where power supplies are taxed so severely do not come up often.

Using the tester

Assuming the IC follows the convention of V_{CC} at the last pin of the second row (i.e. pin 14 in a 14-pin DIP, pin 18 in an 18-pin DIP, etc.) and ground at the last pin of the first row (i.e. pin 7 in a 14-pin DIP, pin 9 in an 18-pin DIP, etc.) set up is a simple procedure. Just connect the tester to power and ground and attach the appropriate IC clip to the IC to be tested.

Two such IC clips are provided. One is for use with IC's of 20 pins or less; the other, which is especially designed for use in close quarters, is for IC's of 16 pins or less. In even closer quarters, however, it is possible that neither clip will serve. The manufacturer has provided in the manual (which, incidentally, was very well done) a source for compatible clips for those instances. Next, select the appropriate package type (14, 16, 18, or 20) using the row of pushbuttons located at the bottom of the front panel. Then press the TEST switch. If the GOOD LED lights, you can proceed with the testing.

Note that a GOOD indication at that stage (before a reference IC has been placed in the tester)

For Quality 3½ or 4½ Digit Hand-Held DMMS

Ask for
Simpson®

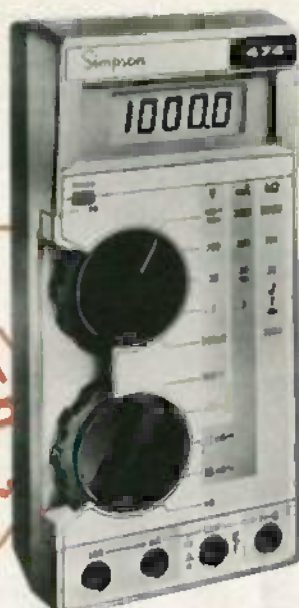
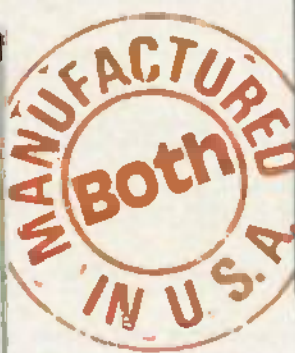

4½ Digit 474™
.03% Basic DC Accuracy
\$219

3½ Digit 470™
.15% Basic DC Accuracy
\$139

FULL FUNCTION DMMs WITH THESE MOST WANTED FEATURES . . .

- ✓ Full Measurement Capability
- ✓ 6 kV Transient Protection
- ✓ Double Fusing System
- ✓ Audible Continuity Indication
- ✓ Diode Test Function
- ✓ User Engineered Range/Function Selector Knobs
- ✓ Large, Easy-to-Read LCD Display
- ✓ High Impact ABS Case
- ✓ 2-Way Tilt Stnd
- ✓ Extended Battery Life
- ✓ UL Recognized Test Leads
- ✓ Full Line of Optional Accessories
- ✓ Full Simpson Warranty

AT LEADING ELECTRICAL/ELECTRONICS DISTRIBUTORS



SIMPSON ELECTRIC COMPANY

853 Dundee Avenue, Elgin, Illinois 60120-3090
(312) 697-2260 • Telex 72-2416
Cable SIMELCO

Which Way To YOUR Future?

Are you at a crossroads in your career? Have you really thought about it? Are you *planning* for your future, or perhaps refusing to face the subject? Which way will you go — down the same old road? Or are you ready for something else?

In electronics you can't stand still. If you are not moving ahead, then you're falling behind. At the crossroads of your career, various choices are available — and, yes, *decisions* have to be made.

Which road will you take — one that doesn't go where you want to be, or one that leads to hard work *but also* to the better life? Ah, decisions, decisions!

Career decisions are so important that you need all the *input* you can get before locking-in on one of them. Grantham College of Engineering offers you *one* source of input which may help you in making that decision. It's our free catalog.

Ask for our free catalog and you may be surprised to learn how it is easily possible to earn a B.S. degree in electronics without attending traditional classes. Since you are already in electronics (you are, aren't you?), you can complete your B.S. degree work with Grantham while studying at home or at any convenient place.

But don't expect to earn that degree without hard work. Any degree that's worth your effort can't be had without giving effort to the task. And of course it is what you learn in the process, as much as the degree itself, that makes you stand out above the crowd — that places you in an enviable position, prestige-wise and financially.

Grantham College of Engineering
10570 Humbolt Street
Los Alamitos, California, 90720

**This booklet
FREE!**

This free booklet explains the Grantham B.S. Degree Program, offered by independent study to those who work in electronics.



for
**FREE
Booklet
CLIP
COUPON**
and mail in
envelope or
paste on
postal
card.

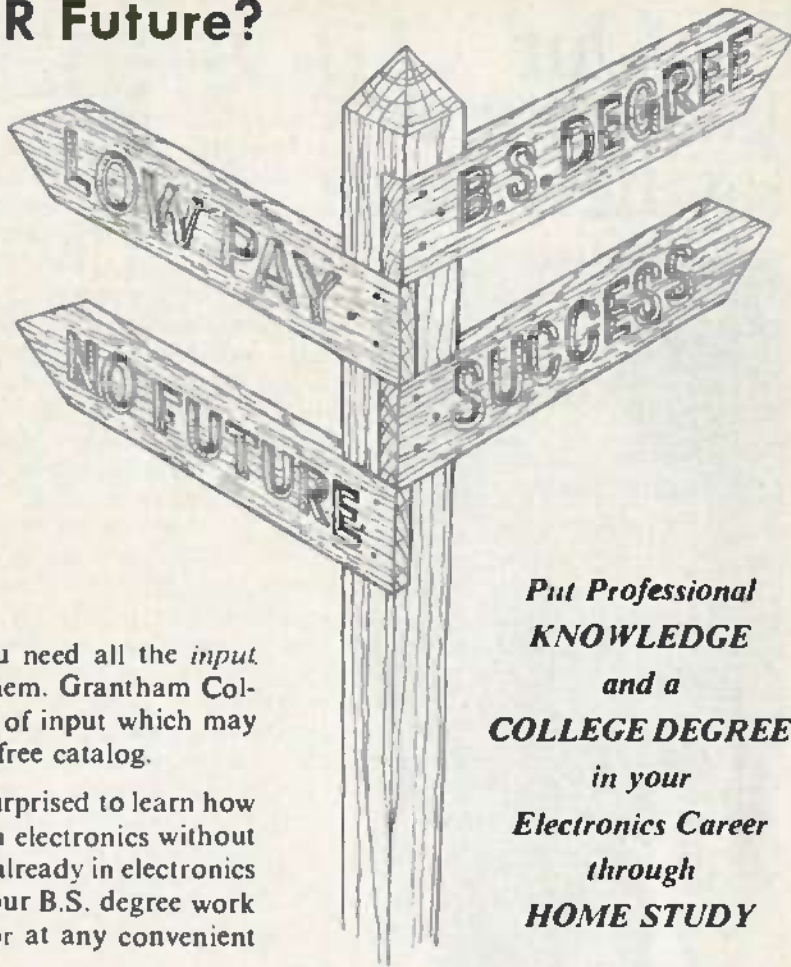

**Put Professional
KNOWLEDGE
and a
COLLEGE DEGREE
in your
Electronics Career
through
HOME STUDY**

Grantham offers this program, complete but without laboratory, to electronics technicians whose objectives are to upgrade their level of technical employment.

Recognition and Quality Assurance

Grantham College of Engineering is accredited by the Accrediting Commission of the National Home Study Council, as a degree-granting institution.

All lessons and other study materials, as well as communications between the college and students, are in the English language. However, we have students in many foreign countries; about 80% of our students live in the United States of America.

Grantham College of Engineering R-08-86
10570 Humbolt Street, Los Alamitos, CA 90720

Please mail me your free catalog which explains your B.S. Degree independent-study program.

Name _____ Age _____

Address _____

City _____ State _____ Zip _____

AUGUST 1986

Our guaranteed savings plan.



Fluke 70 Series Analog/Digital multimeters are like money in the bank. Buy one, and you're guaranteed to save both time and money.

Money, because you get longer battery life and longer warranty coverage — 3 years vs. 1 year or less on others.

And time, because 70 Series meters are easier to operate and have more automatic measurement features.

So before buying any meter, look beyond the sticker price. And take a closer look at the new low-priced \$79 Fluke 73, the \$99 Fluke 75, and the deluxe \$139 Fluke 77. In the long run, they'll cost less, and give higher performance, too.

And that, you can bank on.

FROM THE WORLD LEADER
IN DIGITAL MULTIMETERS.



© 1985 Fluke

merely indicates that some connection between ground and the IC clip has been established. It is not a fail-safe confirmation that all connections have been made properly. To be sure connections are made correctly, the clip should be attached carefully, but firmly.

To use the unit as an IC tester, a known-good reference IC must be placed in the Zero Insertion Force (ZIF) socket located at the center of the front panel. Be sure to use only an identical IC. Do not choose a functionally equivalent IC from a different family. For example, when testing 7402, do not use a 74LS02 as the reference IC.

Once the reference IC is secured in the ZIF socket, the test is performed by pressing the test button once again. If all logic levels at the test and reference IC's match, the IC is OK. That is indicated by a lit GOOD LED. If the logic levels don't match, the IC is defective. In that case the GOOD LED remains dark, but individual LED's at each pin indicate where the mismatches have occurred.

If you are using an IC that does not follow the power/ground pin convention as previously discussed, one additional step needs to be performed. That is to set the tester to accept non-standard power and ground pins. That is done using a pair of DIP switches located at the top of the unit's front panel.

Use as a logic monitor is even easier. Simply connect the tester to power, place the clip on the IC to be monitored, and press the LOGIC/LED TEST switch. No reference IC should be used.

Limitations

As you might expect, the 550 is not without its limitations. Those are clearly spelled out in the excellent instruction manual that accompanies the tester. First of all, sequential logic devices present more of a problem for the tester than do combinational logic circuits. That's because combinational circuits usually change outputs simultaneously (for all practical purposes) with changes in inputs. In sequential devices there is usually a built-in delay of some type. For a sequential device to be tested using a logic com-

parator technique, which is the technique used by the 550, the device under test and the reference device must be synchronized and contain the same data.

Further, as outlined in the manual, there are many conditions that could cause incorrect results. For instance, the tests should be performed under dynamic conditions. That is, all inputs and outputs should be changing. Other conditions or factors that could affect testing include open-circuit outputs, the presence of external timing components, and loading beyond rated fan-out. Also, the nature of the device itself must be considered in doing the tests. For instance, if a counter or flip-flop does not test good at first, all that may need to be done is to reset the device. Other types of devices present more serious obstacles; potential trouble spots are open-collector devices, three-state devices, edge-triggered devices, and storage devices.

B + K Dynascan		550												
OVERALL PRICE														
EASE OF USE														
INSTRUCTION MANUAL														
PRICE/VALUE														
		1	2	3	4	5	6	7	8	9	10			
		Poor		Fair			Good			Excellent				

On the whole, however, we liked the unit. It has some limitations, but those are outweighed by its usefulness, especially to those involved with the troubleshooting and repair of digital circuits. Our only complaints, and they are relatively minor, are the potential problems that could arise from the power-supply scheme used and the use of DIP switches for configuring the tester for non-standard IC's; this reviewer finds those switches an inconvenience.

Note that the 550 will not test CMOS devices. For those, Dynascan has another model, the 552 CMOS IC tester; that unit was not reviewed by us.

The model 550 is covered by a one-year warranty. R-E

Nady WTS-1 Wireless Speaker System

Here's a wireless speaker system with versatility.



CIRCLE 10 ON FREE INFORMATION CARD

IF YOU'VE BEEN LOOKING FOR A CONVENIENT, portable PA system, or a way to bring your stereo system outdoors, or for a way to play your electric guitar at the beach, you'll want to take a look at the WTS-1 wireless speaker system from Nady Systems, Inc. (1145 65th Street, Oakland, CA 94608).

The WTS-1 consists of two wireless amplifier/speakers, (which we'll call wireless speakers) and a stereo transmitter with microphone. The system has a range of about 100 to 200 feet.

Wireless amplified speakers

The wireless speakers, model WS-2, are housed in sturdy, vinyl-covered particle-board cabinets that are obviously designed to take a beating. Each wireless speaker consists of three sections: the receiver, the amplifier, and, of course, the speakers. The receiver section of the WS-2 has switch-selectable frequencies of 49.830 MHz or 49.875 Mhz. As you might expect, those frequencies correspond to the transmitter's outputs.

The amplifier section has a power output of 15 watts into 4 ohms with a THD rated at 1% (at full power). The rated signal-to-noise ratio is greater than 60 dB, and the frequency response is 40

Hz to 15 kHz. Obviously, the system is designed more as a PA system than for hi-fi reproduction. However, we don't really think that's a problem. We think that these speakers will probably be used most at outdoor parties, etc., where high fidelity is not of the greatest importance. The speaker section consists of a 6½-inch woofer and a 1¼-inch cone-type tweeter.

The WS-2 wireless speakers are not limited to receiving and ampli-

fying 49-MHz signals; they can also can be used as PA systems or musical-instrument amplifiers. They accept low-level signals (from, for example a microphone or electric guitar) through its MIC jack, and they also accept line-level inputs (from a tape deck) through its LINE IN jack. If signals are applied to both input jacks, they will be mixed automatically.

Each wireless speaker features volume, tone, and squelch controls. The squelch control, if used

Build Circuits Faster and Easier With Our \$20 Solderless Breadboard



...and do even more with our \$40 breadboard

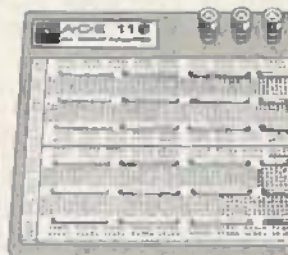

Introducing the plug-in world of AP Product's versatile, low cost breadboards.

Now you can design, build and test prototype circuits just like the professionals... and make changes in seconds. No messy soldering or desoldering. No more twisted leads or damaged devices.

With our ACE 109 and 118 blue breadboards, you simply plug in components and interconnect them with ordinary hook-up wire. All sizes of DIPs and other discrete components up to 22 gauge lead diameters snap right into the 0.1" x 0.1" matrix of the solderless tie points... anywhere on the layout. You don't need expensive sockets or special tools. Buses of spring clip terminals form a distribution network for power, ground and clock lines.

AP Product's 100 series breadboards give you all the functions and flexibility of more expensive circuit evaluators. The spring terminals have mechanically independent contact fingers to accom-

modate most DIPs and discrete components (see diagram).

The ACE 109 has two terminals for separate voltages plus a ground connection. The larger ACE 118 offers the same three terminals, plus an additional terminal which can be used for clocking or another voltage. The backplates are heavy steel to keep the boards stationary.

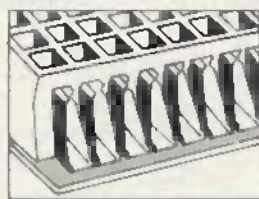

Don't wait. These low prices won't last forever. See your local AP Products dealer today, or send for a list of dealers in your area. Free information on request.

AP PRODUCTS/3M
9325 Progress Parkway
P.O. Box 540
Mentor, Ohio 44060
800-321-9668
(Ohio, 216/354-2101)

CIRCLE 76 ON FREE INFORMATION CARD

properly, is very useful for eliminating the background hash that's inherent in 49-MHz systems.

There are six LED's on the front panel: One LED indicates that power is on. A TXON LED indicates that a signal is being received from the transmitter and a bank of 4 green LED's indicate the amplifier's output power. As you might expect, the speaker also includes a telescopic rod antenna.

The WS-2 can be powered by eight "D" cells, 12 volts DC from, for example, a car's electrical system, or by 12 volts AC from the supplied wall transformer. That transformer can also be used to charge internal Ni-Cd batteries; the WS-2 includes overcharge-protection circuitry.

FM stereo transmitter

The WLT wireless stereo transmitter has an output power of 40 mW (or a field strength of 30,000 microvolts/meter at 3 meters), which is the maximum output allowed by current FCC regulations. Two transmitter frequencies are switch selectable: 49.830 and 49.875 MHz. A three-position slide switch allows operation at either—or both—of those frequencies.

Nady		WTS-1									
OVERALL PRICE											
EASE OF USE											
INSTRUCTION MANUAL											
PRICE/VALUE											
		1	2	3	4	5	6	7	8	9	10
		Poor	Fair	Good	Excellent						

Unless stereo operation is a must, only a single output should be used. That's because the transmitter draws double the current in the stereo mode, and you will be forced to use the 9-volt DC wall-mount adapter instead of a battery.

The transmitter is pocket-sized (about 2½ × 4¼ × 1¼ inches) and weighs just over ½ pound. The belt clip makes it comfortable to wear. A lavalier microphone is included. (Lavalier microphones are inconspicuous chest-mounted pickups.) The transmitter, like the wireless speakers, accepts either line-level or low-level inputs. So the system can be used as a way to free an electric-guitar player from his amplifier cable.

If signals are applied to both in-

puts, they can be mixed using the transmitter's VOLUME control (which affects only the low-level input). A small patch cord allows you to input stereo signals from line-level sources.

The Nady WTS-1 wireless speaker system lives up to the claims of its manufacturer. Because of its less-than-Hi-Fi performance, we wouldn't recommend it as a way to add an extra set of speakers to your stereo system. But we think it works great as a portable PA system. It's also an excellent way to set up stereo speakers for those summer outdoor parties and barbecues. The speakers' 15-watt outputs hold up very well outdoors.

One drawback of the system is that it cannot be AC-powered outdoors. (The adapters are UL approved for indoor use only.) We think that Nady should have included on-board power supplies in their speakers. (We don't particularly care for those cumbersome wall-mount transformers anyway.) The system's 100- to 200-foot range should be sufficient for most applications. The WTS-1 system sells for \$299. The individual components are also available separately. R-E

Send Purchase Order
Check Money Order, or C.O.D.
or Call Toll Free
800-223-0826
In N.Y. State (212) 865-5580

CABLE BOXES

\$69⁹⁵ JERROLD CORDLESS
CABLE TV CONVERTER
Model DRX3-105-100 (58 channels)



CO-AXIAL CABLE

Branded bare
Copper Shield

RG 59/u

39⁹⁵

44' 1000'

RG-6/u 63"

Add \$5.00 per Roll for Shipping

5000' up
Foil polyethylene
dielectric

Bare Copper
Conductor

JERROLD CORDLESS
CABLE TV CONVERTER
Model DRZ1450

\$69⁹⁵
10 lot
\$79⁹⁵ ea.

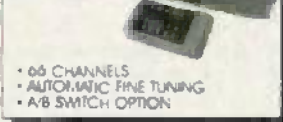

- 66 CHANNELS
- AUTOMATIC FINE TUNING
- A/B SWITCH OPTION

TEKNICA CORDLESS
CABLE TV CONVERTER
Model 6510

\$139⁹⁵



- VOLUME CONTROL
- 140 CHANNEL CAPABILITY

JERROLD CORDED
CABLE TV CONVERTER
Model JRX3-105

\$49⁹⁵



- 30 channel

"F" - FITTINGS

F-59ALM with attached
½" ring for RG-59/u cable
12¢/100 9¢/1000 **7¢**/5000



F-56ALM with attached
½" ring for RG-6/u cable
15¢/100 10¢/1000 **8¢**/5000

HITACHI 100-60-40-20 MHz SCOPES



PROBES INCLUDED

V-212-20 MHz	\$460
V-222-20 MHz	\$535
V-223-20 MHz	\$599 DELAYED SWEEP
V-422-40 MHz	\$689
V-423-40 MHz	\$749 DELAYED SWEEP
V-650-60 MHz	\$950 DELAYED SWEEP
V1050-100 MHz	\$1250 DELAYED SWEEP QUAD TRACE

■ MASTER CARD ■ VISA

OMNITRON ELECTRONICS

770 Amsterdam Ave., New York, NY 10025

SHIPPING CHARGES

For Orders	Add
\$25-100	\$6.50
\$100-500	\$8.50
\$500-750	\$10.50
\$750 and up	\$20.00



CIRCLE 110 ON FREE INFORMATION CARD

www.americanradiohistory.com

NEW IDEAS

Simple cable tester

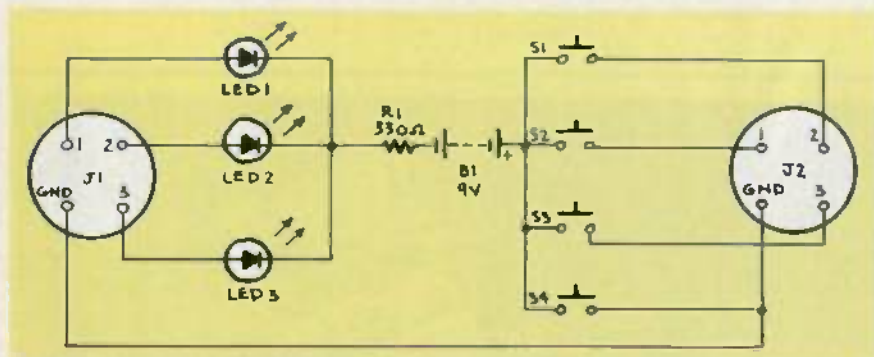

FIG. 1

AS ANY BROADCAST OR RECORDING engineer knows, microphone and other cables have a tendency to give out just when you need them most. Of course you can field-test a cable before a recording session or concert is supposed to begin, but by then it may be too late. It would be better to test all cables before laying them out and hooking them up. That's why I built the simple cable tester described here. I use it primarily for audio applications, but it could be adapted for use anywhere reliable cabling is a necessity—video circuits, computer circuits, etc.

As you can see in Fig. 1, the circuit is a continuity tester. Two jacks are provided that match the ends of the cable to be tested. An LED and a separate momentary switch are wired in series with each line. A separate switch (S4) is provided to test for a ground-line fault. With the cable to be tested plugged in, switches S1–S3 are pressed one at a time. If the corresponding LED lights up, that conductor is good; if the LED doesn't light up, that conductor probably has an open circuit. Switch S4 helps determine if a conductor is shorted to a connector's housing. When you press S4 (with no other switch depressed), no LED should light; if one does, there is a short.

The tester can also be used to indicate whether a cable is correctly wired. If, for example, switch S1 is pressed, but LED2 lights up, two or more conductors have been wired incorrectly.

When testing a cable, it's usually a good idea to flex it near any connectors and splices while watching the LED's. If an LED blinks, that cable has an intermittent that *could* cause trouble, and probably *will* cause trouble at an inopportune moment.

Construction

You can build the tester in any convenient enclosure. If your jacks are the non-insulated type, be sure to insulate them from any metallic chassis or cover plates, or the ground-fault test circuit won't work properly. It's probably best not to use slide switches, because if more than one switch were on at the same time, an erroneous reading could result. But you could use a rotary switch. Any common junk-box parts should suffice for the other components.

To increase functionality of the tester, you could wire a number of different jacks in parallel so that you could test a number of different cables with one tester. Just label each connector and switch clearly.—Roger Doering.

NEW IDEAS

This column is devoted to new ideas, circuits, device applications, construction techniques, helpful hints, etc.

All published entries, upon publication, will earn \$25. In addition, for U.S. residents only, Panavise will donate their model 333—The Rapid Assembly Circuit Board Holder, having a retail price of \$39.95. It features an eight-position rotating adjustment, indexing at 45-degree increments, and six positive lock positions in the vertical plane, giving you a full ten-inch height adjustment for comfortable working.



I agree to the above terms, and grant Radio-Electronics Magazine the right to publish my idea and to subsequently republish my idea in collections or compilations of reprints of similar articles. I declare that the attached idea is my own original material and that its publication does not violate any other copyright. I also declare that this material has not been previously published.

Title of Idea

Signature

Print Name

Date

Street

City

State

Zip

Mail your ideas along with this coupon to: New Ideas Radio-Electronics, 500-B Bt-County Blvd., Farmingdale, NY 11735

AUGUST 1986

SUPER LONG PLAY TAPE RECORDERS

10 Hour Model — \$95.00*
14 Hour Model — \$159.00*

Modified Panasonic Slimline, high quality, AC-DC Recorders provide 5 or 7 continuous hours of quality recording & playback on each side of cassette for a total of 10 or 14 hours depending on model. Built-in features include • Voice level control, • Digital counter, etc. TDK DC 180 Cassette Furnished.



PHONE RECORDING ADAPTER

Records calls automatically. All Solid state connects to your telephone jack and tape recorder. Starts recording when phone is lifted. Stops when you hang up.

\$24.50*

FCC APPROVED

VOX VOICE ACTIVATED CONTROL SWITCH

Solid state. Self contained. Adjustable sensitivity. Voices or other sounds automatically activate and control recorder. Uses either recorder or remote mike.

\$24.95*

*Add for ship & hdg. Phone Adapter & Vox \$1.50 ea. Recorders \$4.00 ea. Cal. Res. add tax. Mail order, VISA avail. Dealer Inquiries invited. Free data.

AMC SALES INC., Dept A 9335 Lubec St., Box 928, Downey, CA 90421 (713) 869-8510

CIRCLE 108 ON FREE INFORMATION CARD

SEND FOR THIS FREE CATALOG NOW



SAVE MONEY HIGH QUALITY FAST DELIVERY

We are utilizing the latest equipment and technology to maintain our quality at reasonable prices.

- General Communication
- Industry
- Marine VHF
- Scanners
- Amateur Bands
- CB Standard
- CB Special
- Microprocessor

Call or Write
JAN CRYSTALS
P.O. Box 06017
Fort Myers
FL 33906-6017
(813) 936-2397

JAN CRYSTALS
Since 1958



CIRCLE 104 ON FREE INFORMATION CARD

NEW PRODUCTS

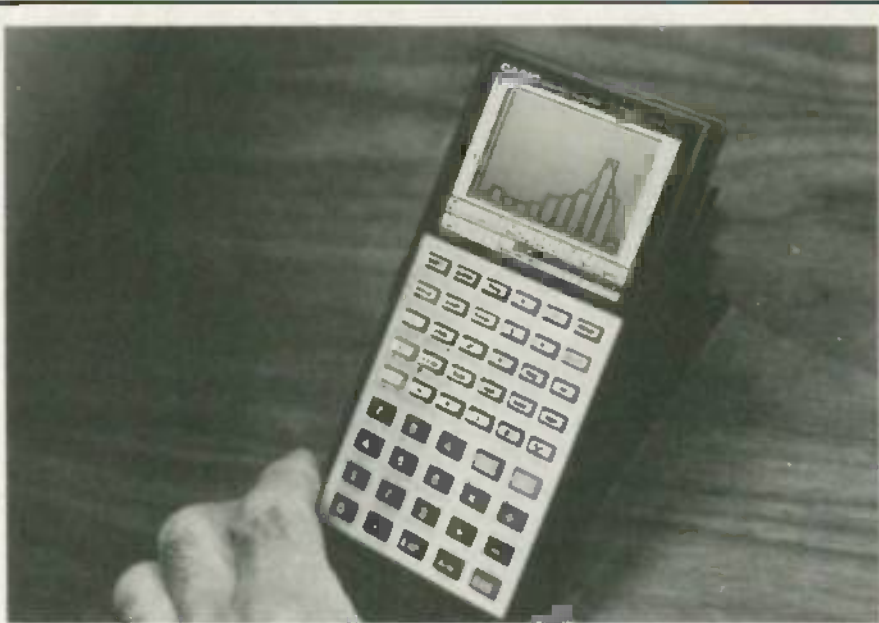

CIRCLE 21 ON FREE INFORMATION CARD

POCKET CALCULATOR, the model *FX-7000C*, is capable of displaying numerical equations as graphs at the touch of a key. With the ability to show characteristics of a wide range of mathematical functions, the calculator reduces the calculating time of many scientific and engineering functions.

The calculator measures 3.3 × 6.6 × 0.5 (inches) and it weighs 5.5 ounces. Its LCD panel measures 2.17" × 1.5", and has a resolution of 96 × 64 dots. The calculator can display the results of a single-function equation, and it can display

changes in numerical values as fluctuations in the display. Also, two or more equations can be simultaneously displayed on a graph, and several equations can be mixed together to formulate a combined graph. Further, overall (and local) maximum and minimum points, intersection and approach of different functions, and other features, can be seen by a simple keyboard operation.

The model *FX-7000G* has a suggested retail price of \$69.95.—Casio, Inc., 15 Gardner Road, Fairfield, NJ 07006.

CLOSE-FIELD PROBE, the model *HP 11940A*, is a calibrated magnetic-field sensor that helps locate sources of electromagnetic emission and makes repeatable measurements from 30 MHz to 1 GHz.

The hand-held device uses a dual-loop configuration and a bal-







un to provide common-mode rejection of electric field components. Calibration is accurate to ±2 dB in a 377-ohm field impedance. The probe maneuvers easily around enclosures and cabling, allowing emission hot-spots to be pinpointed accurately. The radi-

saving you money for over 45 years

WM. B. ALLEN

slashes prices on the new oscilloscopes from

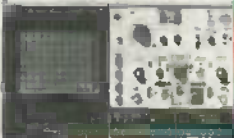

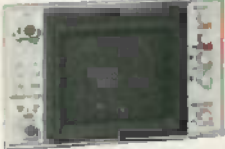
<p>V089 Vector Scope/3.5" CRT/AC Operated/Optional Battery Pack/ External DC Source</p>  <p>\$1390 SAVE \$200!</p>	<p>V509 50MHz/Dual Channels Mini Portable/Delayed Sweep</p>  <p>\$1199 SAVE \$200!</p>	<p>V134 10 MHz/Dual Traces/BI-Stable Storage</p>  <p>\$1395 SAVE \$225!</p>
<p>V1100A 100MHz/Quad Channels/8-Trace/Delayed Sweep/ CRT Readout/Digital Measurement</p>  <p>\$2190 SAVE \$300!</p>	<p>VC6020 Digital Storage Scope/1MHz Dual Channel/ 20MHz Real Time/ GPB Option/1K Words Memory per Channel</p>  <p>\$1700 SAVE \$250!</p>	<p>V1070A 100MHz Quad Channels 8-trace Delayed Sweep CRT Readout</p>  <p>\$1595 SAVE \$355!</p>
<p>V680 50MHz/3 Channels/8 Trace/Delayed Sweep/Output Measurement/ CRT Readout</p>  <p>\$1340 SAVE \$150</p>	<p>THE 928 PAGE WM. B. ALLEN ELECTRONICS CATALOG A \$15.00 VALUE FREE WITH EVERY PURCHASE</p>	<p>V209 20MHz/Dual Channels/AC-DC Operation/Mini Portable</p>  <p>\$795 SAVE \$150!</p>
<p>V079 Waveform Monitor/2Loop-through Inputs/AC-DC Input Coupling/ Video Output IRE Pos. IEEE 205/Half-rack Width/6" CRT</p>  <p>\$1800 SAVE \$300!</p>	<p>VC6041UG 40MHz Digital Storage 1mV Dual Trace 6" CRT 4k Words per Channel GPB Option</p>  <p>\$5100 SAVE \$850!</p>	<p>V099 Waveform Monitor 3.5" CRT AC Operated Optional Battery Pack External DC Source</p>  <p>\$1050 SAVE \$200!</p>
<p>V1150 150MHz/Quad Channels/8 Traces/Delayed Sweep/Digital Measurement/CRT Readout</p>  <p>\$2550 SAVE \$400!</p>	<p>VC6041UX 40MHz Digital Storage 1mV Dual Trace 6" CRT 4k Words per Channel</p>  <p>\$4350 SAVE \$600!</p>	<p>V069 VectorScope/6" CRT w/Internal Graticule/AC/Power/ 100-120-220-240v/50-60Hz</p>  <p>\$2090 SAVE \$300!</p>

— and still making waves —

<p>V1050F 100MHz/Quad Channels/ 8-Traces/Delayed Sweep</p> <p>SAVE \$300! \$1245</p>	<p>V650F 60MHz/Triple Channels/ Delayed Sweep</p> <p>SAVE \$250! \$945</p>	<p>V423 40MHz/Dual Channels/ Single Time Base Delayed Sweep</p> <p>SAVE \$250! \$745</p>	<p>V422 40MHz/Dual Channels</p> <p>SAVE \$250! \$675</p>	<p>V223 20MHz/Dual Channels/ Single Time Axis Delayed Sweep</p> <p>SAVE \$200! \$595</p>	<p>V222 20MHz/Dual Channels</p> <p>SAVE \$200! \$515</p>	<p>V212 20MHz/Dual Channels</p> <p>SAVE \$150! \$465</p>
--	--	--	--	--	--	--

WM. B. ALLEN SUPPLY COMPANY

ALLEN SQUARE

300 BLOCK NORTH RAMPART, NEW ORLEANS, LA 70112

NEW ORLEANS 504 525-8222 **800 535-9593** LOUISIANA 800 462-9520

24 HOUR ANSWERING TO EXPEDITE YOUR ORDER

CIRCLE 103 ON FREE INFORMATION CARD

AUGUST 1986

Power to the Product!

Low cost B&K-PRECISION DC power supplies with high cost features

NEW



Model 1630 (3 amp) \$225
Model 1610 (1 amp) \$150

Now you can have the power you need, wherever you need it, at a surprisingly low cost.

These new B&K-PRECISION power sources each give you control up to 30 volts DC with fully adjustable current limiting. Other features include:

- Excellent regulation and low-ripple characteristics
- Dual meters monitor voltage and current simultaneously
- Two current ranges
- Fine and coarse voltage controls
- Isolated output
- Protected against reverse polarity external voltages
- Two identical supplies can be connected in series or parallel
- Can be used as a constant voltage or constant current source

Compare prices, features and performance, and you'll agree that the 1610 and 1630 power supplies are revolutionary.

Available for immediate delivery at your local B&K-PRECISION distributor. For additional information or the name of your local distributor contact B&K-PRECISION.

B&K PRECISION
DYNASCAN
CORPORATION

6460 West Cortland Street
Chicago, Illinois 60635 • 312/889-9087

International Sales: 6460 W. Cortland St., Chicago, IL 60635
Canadian Sales: Atlas Electronics, Ontario
South and Central American Sales:
Importe Exportores, Pinarol, 07-1100



CIRCLE 22 ON FREE INFORMATION CARD

ated field of an emission is sensed magnetically by the probe, which is passive, so it does not require a power supply.

The probe can also be used as a localized magnetic-field source for indentifying susceptibility problems. A voltage fed into the probe creates a small magnetic field at the loops. For that application, the maximum input power is 0.5 watts.

The model HP 11940A is priced at \$500.00.—Hewlett-Packard Company, Inquiries Manager, 1820 Embarcadero Road, Palo Alto, CA 94303.

SPEAKER ENCLOSURE, the *SpeakerMates IV*, made of Acoustifoam™, is designed for 4" round speakers. A 5" passive radiator is optional. The passive radiator version offers about 3 dB more low-frequency output (a 50% improvement) and about 1/3-octave deep-base extension.



CIRCLE 23 ON FREE INFORMATION CARD

The standard model lists for \$29.95, and the passive radiator model for \$39.95.—SpeakerMates, 129 S. E. 9th Street #5, Bend, OR 97702.

DMM, the model 3430, is a 4½-digit, hand-held, multi-function instrument with 13 different functions and three operating modes. It is a 25,000-count instrument, which allows full 4½-digit resolution to the second decimal place for readings such as 240.15 volts

AC. The unit measures true rms for both AC voltage and current.

Special features include: a relative mode that uses the input applied when that mode is selected as a zero reference point for subsequent measurements; digital display of dBm values referenced to 600 ohms (1 mW is 0 dBm); auto-ranging, manual, and, for fast survey measurements, 3½-digit modes; data hold; peak hold; temperature measurement with external probe; 100 kHz frequency counter; diode test; and audible continuity checker.



CIRCLE 24 ON FREE INFORMATION CARD

The model 3430 is priced at \$339.00. The model 3450 is similar except that its AC measurements are based on average, not rms values, and the meter has no peak hold and temperature measurement capabilities. The model 3450 lists for \$299.00.—North American Soar Corp., 1126 Cornell Avenue, Cherry Hill, NJ 08002.

OSCILLOSCOPE, the model 9020, is a compact, dual-trace oscilloscope with a maximum speed of 50 nanoseconds per division



CIRCLE 25 ON FREE INFORMATION CARD

and 1 millivolt per division sensitivity. The six-inch CRT provides a variety of displays: channel 1 only (normal or inverted), channel 2 only, alternate, chop, or channel 1 plus channel 2. An XY feature has been incorporated into this model as well as a "hold-off" feature, which maintains a stable, easy-to-read display. The model 9020 is priced at \$495.00 (suggested retail), including operations manual and two $\times 1/\times 10$ probes.—Beckman Industrial Corporation, 630 Puente Street, Brea, CA 92621.

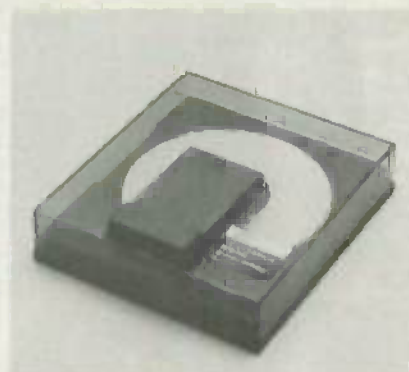

CIRCLE 26 ON FREE INFORMATION CARD

COMPACT DISC CLEANER, the model AT6030, is designed to keep compact discs in immaculate playing condition while preventing accidental surface damage. The disc to be cleaned is placed label-side down on the system's turntable. A hinged, transparent dust cover is then closed, and a slide lever on top is moved back and forth. Each movement rotates the disc about 30°. As the disc revolves, it makes gentle contact with a soft, specially-constructed cleaning pad.

The motion is repeated until the disc makes a complete revolution.

A fine-bristled brush, included, is used to remove dust and dirt from the pad, and an extra pad is included, permitting replacement when the original becomes soiled.

Although the system is used dry, a special cleaning fluid and cleaning paper are included for careful hand treatment of especially obstinate dirt and spots. The model AT6030 is priced at \$27.95.—Audio-Technica U.S., Inc., 1221 Commerce Drive, Stow, OH 44224.

DUAL-TRACE SCOPE MEMORY, the model 602, is an add-on device that converts an analog oscilloscope into a dual-channel digital storage scope. Easily connected to any standard dual-channel scope, the unit is an economical alternative to the purchase of a complete new scope.

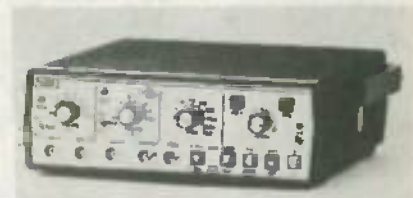

CIRCLE 27 ON FREE INFORMATION CARD

The model 602 stores both analog and digital signals in a single sweep. It features 18 selectable sample times with a 1.4-MHz maximum sampling rate. Each input is selectable in 8 ranges and a 2K memory for data storage.

The model 602 is priced at \$895.00.—Sibex, Inc., 3320 U.S. 19N, Suite 410, Clearwater, FL 33519. R-E

Copies of articles from this publication are now available from the UMI Article Clearinghouse.

For more information about the Clearinghouse, please fill out and mail back the coupon below.

UMI Article Clearinghouse

Yes! I would like to know more about UMI Article Clearinghouse. I am interested in electronic ordering through the following system(s):

- DIALOG/Dialorder ITT Dialcom
 OnType OCLC ILL Subsystem

Other (Please specify) _____

I am interested in sending my order by mail.

Please send me your current catalog and user instructions for the system(s) I checked above.

Name _____

Title _____

Institution/Company _____

Department _____

Address _____

City _____ State _____ Zip _____

Phone (_____) _____

Mail to: University Microfilms International
 300 North Zeeb Road, Box 91 Ann Arbor, MI 48106

Call us FREE 1-800-626-6343

or write for FREE Flyer.

COPPER ELECTRONICS

4200 PRODUCE ROAD - LOUISVILLE, KY. 40217

<p>RAEBIT VCR Multiplying System</p> <p>6 LOT 64.95</p> <p>Retail 139.95 69.95</p>	<p>WHISTLER</p> <p>Q2500 Superhel Quadradyne Radar Detector</p> <p>Retail 239.96 119.95</p>
<p>Snake Charmer</p> <p>Retail 119.96 59.95</p> <p>QUANTITY PRICING AVAILABLE</p> <ol style="list-style-type: none"> 1. FORWARD WINDING AND REWINDING 2. CALIBRATE FOR SLP (SLOW) STOPPING ONLY 3. POWER ATTITUDE RANGE SETTING 4. SLEWED ENTER STOP/PAUSE 	<p>uiden Beacon</p> <p>800XLT AIR POLICE/800 MHz SCANNING RADIO</p> <p>Retail 449.96 289.95</p>

LOWEST PRICES IN THE COUNTRY!

We have a national factory warranty service on many brands, and we service All CB, Amateur, and Commercial Equipment.

CIRCLE 125 ON FREE INFORMATION CARD

AUGUST 1986

33



With NRI training at home, you can...

Move up to a high paying

And you can start by actually building your own 16-bit IBM-compatible computer!

You can create your own bright, high paying future as an NRI trained computer service technician. The government now reports that computer service and repair is the fastest growing career field. The biggest growth in jobs between now and 1995, according to Department of Labor estimates, will occur in the computer service and repair business, where demand for trained technicians will actually double during the next 10 years! There is still plenty of room for you to get in on the action—if you get the proper training now.

Total computer systems training, only from NRI

If you really want to learn how to work on computers, you have to get *inside* one! And only NRI takes you inside a computer, as powerful and advanced as the Sanyo MBC-550 series! As part of your training, you'll build this Sanyo, which experts have hailed as the "most intriguing" of all the new IBM-compatibles. Computer critics say, "The Sanyo even surpasses the IBM PC in computing speed and graphics quality."

This hands-on experience is backed up with training in programming, circuit design and peripherals. Only NRI gives you such in-depth total systems training.

The kind of understanding built only through experience

Even if you've never had any previous training in electronics, you can succeed with NRI training. You'll start with the basics, rapidly building on the fundamentals of electronics until you master such advanced concepts as digital logic, microprocessor design, and computer memory.

You'll build and test advanced electronic circuits using the exclusive NRI Discovery Lab® and professional Digital Multimeter, both of which are yours to keep.

You'll assemble Sanyo's intelligent keyboard, install the power supply and disk drive, and interface the high resolution monitor—all the while performing hands-on experiments and demonstrations that

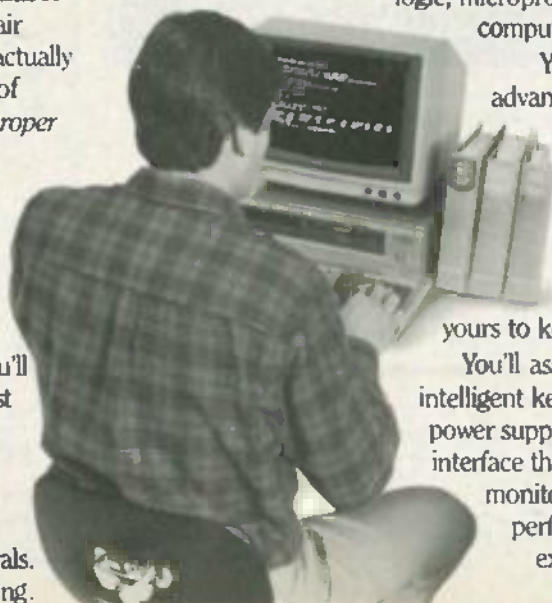



career servicing computers.

fine tune your computer skills. And you also get over \$1,000 worth of software, including WordStar and CalcStar.

Learn to service today's computers

As you train with your Sanyo, you'll gain the knowledge you need to become a computer professional. You'll learn to program in BASIC and machine language. You'll use utility programs to check out the operation of the Sanyo's 8088 microprocessor (the same chip used in the IBM PC). You'll learn how to debug programs and write your own new software.

Most importantly, you'll understand the principles common to all computers. Only a person who fully understands all the fundamentals can hope to be able to tackle all computers. NRI makes sure that you'll get the training you need to maintain, troubleshoot and service computers.

Learn at home in spare time

With NRI training, you'll learn at home on your own time. That means your preparation for a new career or part-time job doesn't have to interfere with your current job. You'll learn at your own pace, in the comfort and convenience of your own home. No classroom pressures, no rigid night school schedules. You're always backed up by the NRI staff and especially your NRI instructor, who will

answer questions, give you guidance and be available for special help if you need it.

Let others worry about computers taking their jobs. With NRI training, you'll soon have computers making good paying jobs for you.

Send for free NRI catalog

Send the post-paid reply card today for NRI's 100-page catalog, that gives all the facts about computer training plus career training in Robotics, Data Communications, TV/Video Servicing and many other fields. If some other ambitious person beat you to the card, write to NRI at the address below.



NRI SCHOOLS

McGraw-Hill Continuing Education Center
3939 Wisconsin Avenue, NW
Washington, DC 20016

We'll Give You Tomorrow: 

IBM is a Registered Trademark of International Business Machines Corporation.

ELENCO PRODUCTS AT DISCOUNT PRICES!

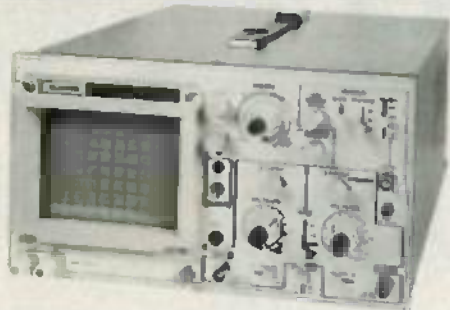

20 MHz DUAL TRACE OSCILLOSCOPE
\$336 MO-1251

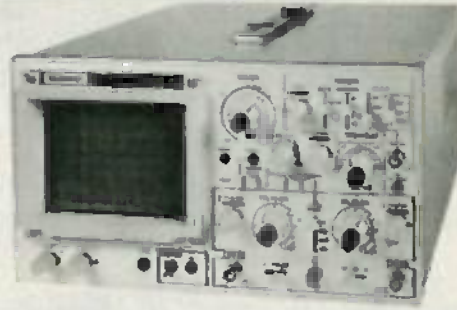

35 MHz DUAL TRACE OSCILLOSCOPE
\$545 MO-1252

Top quality scopes at a very reasonable price. Contains all the desirable features. Elenco's 2 year guarantee assures you of continuous service. Two 1x, 10x probes, diagrams and manual included. Write for specifications.



MULTI METER with CAPACITANCE and transistor tester

\$65 Model CM-1500

Reads Volts, Ohms, Current, Capacitors Transistors & Diodes



TRUE RMS 4 1/2 DIGIT MULTIMETER

\$135 Model M-7000

.05% DC Accuracy
 .1 % Resistance with Freq. Counter & Deluxe Case



3 1/2 DIGIT MULTIMETER

\$25 Model M-1600

1% DC Accuracy
 1% Resistance Reads 10A DC

GF-8016 Function Generator with Freq. Counter

\$219

- Sine, Square, Triangle,
- Pulse, Ramp, .2 to 2 MHz
- Frequency .1 thru 10 MHz



GF 8015 without Freq. Meter \$169

Quad Power Supply

Including 2-20V Variable Supply



Model XP-575

\$59.95

Fully Regulated, Short Protect Specifications 3 @ **\$49.95**

Volts	AMP	Reg	Max Ripple
2-20V	2A	.10V	.005V
12V	1A	.05V	.003V
5V	3A	.10V	.005V
-5V	.4A	.05V	.005V

Triple Power Supply XP-660

\$149.50

0-20V @ 1A
 0-20V @ 1A
 5V @ 5A



Fully Regulated, Short Circuit Protected with 2 Limit Cont. 3 Separate Supplies.

3 Amp Power Supply XP-650

\$119.50

0-40V @ 1.5A
 0-20V @ 3A



Fully regulated, short circuit protected current limit control



DIGITAL LCR METER

Model LC-1800
 Measures: Inductors
 Capacitors, Resistors

\$148

Inductors .1μH to 200 H
 Capacitor .1Pf to 200μf
 Resistor .01Ω to 20M Ω
 Ranges 6 Ind, 7 cap, 7 res

C&S SALES, 8744 W. North Ter. Niles, IL 60648
 800-292-7711 (312) 459-9040



15 DAY MONEY BACK GUARANTEE ASK FOR CATALOG

2 Year Limited Guarantee! Add 5% for Postage (\$10 max.), IL Res., 7% Tax

CIRCLE 109 ON FREE INFORMATION CARD

BUILD THIS

RADAR SPEED-GUN CONTROLLER

ANTHONY STEVENS

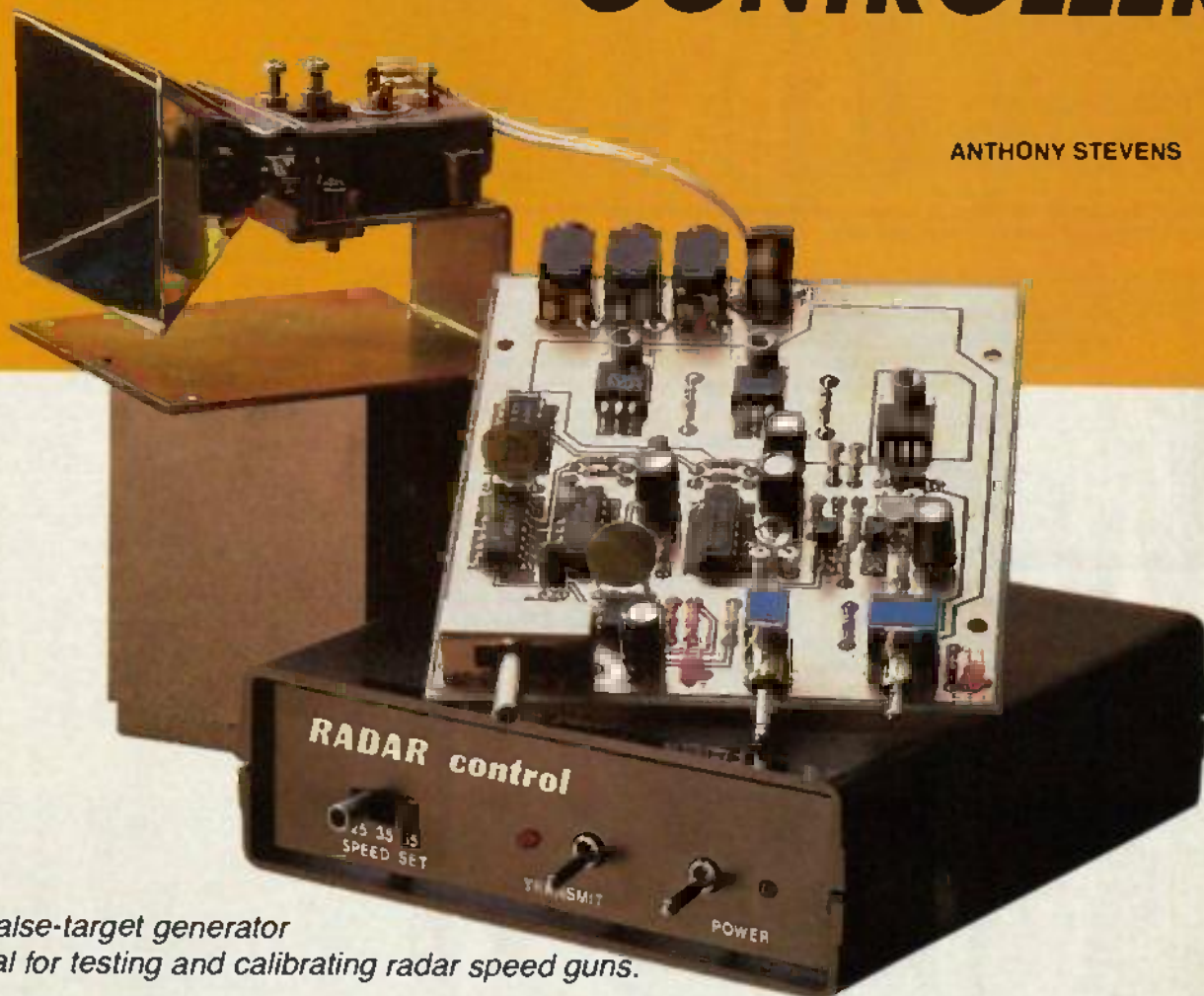

This false-target generator is ideal for testing and calibrating radar speed guns.

SINCE THE FCC HAS ALLOWED THE commercial and private use of some radar frequencies, interest in those frequencies has greatly increased. Amateur-radio operators are actively experimenting with radar for communications. On the commercial front, the burglar-alarm industry has turned to radar for intrusion-detection alarms. Boaters are using radar to guide their crafts through hazardous fog. Even professional baseball teams are getting into the act with radar guns being used to time the speed of their pitchers' deliveries. And of course everyone is familiar with radar through its use by highway police to enforce the speed limit.

As with all other electronics equipment, radar guns need to be calibrated and tested periodically for accuracy. Here is an inexpensive portable calibrator for

radar equipment. It works by generating a false target.

Radar false-target generators are used by the military as electronic camouflage on our stealth aircraft to fool the enemy's radar-tracking missiles. A similar technique is used in this radar gun calibrator. To better understand the technique, we should first understand how radar speed-guns work.

How radar works

The police have been using radar to measure vehicle speed since the late 1940's. A block diagram of a typical radar speed-gun is shown in Fig. 1.

A radar gun uses the *Doppler effect* to determine the speed of a moving object. Its output consists of a steady, unmodulated carrier. The signal travels in a tight

beam toward a target whose speed is being monitored. That target can be any object, such as a speeding baseball—or a speeding motorist. Because of the nature of microwave transmissions, the signals are reflected by the target back toward their source.

Because of the Doppler effect, the frequency of the reflected signal is slightly higher than the original transmitted signal. For each mile per hour an object is travelling toward the radar speed-gun, the reflected signal received by the gun will be shifted about 31 Hz higher. In the radar gun, the return signal is mixed with a sample of the original transmitted wave to produce a difference frequency. That difference frequency is analyzed and converted to produce a direct readout of speed.

AUGUST 1986

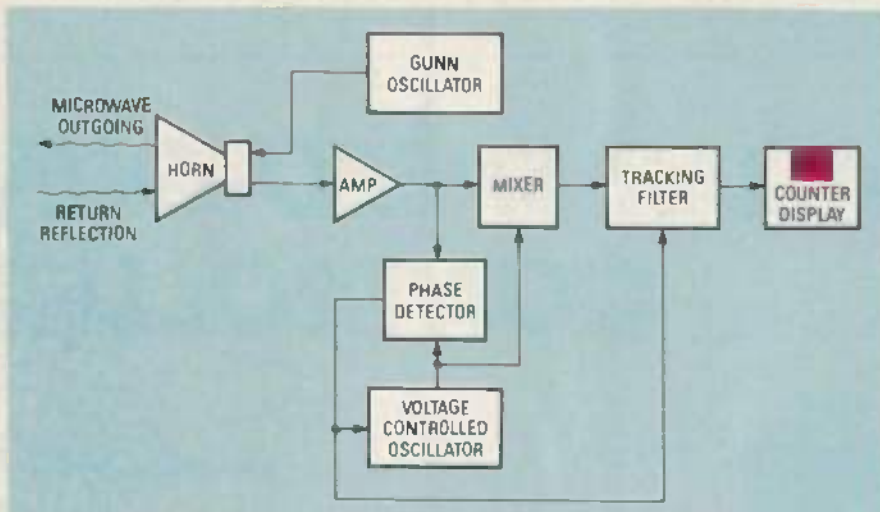

FIG. 1—SPEEDING FASTBALLS, or speeding motorists, can be timed using a radar speed-gun. A block diagram of such a unit is shown here.

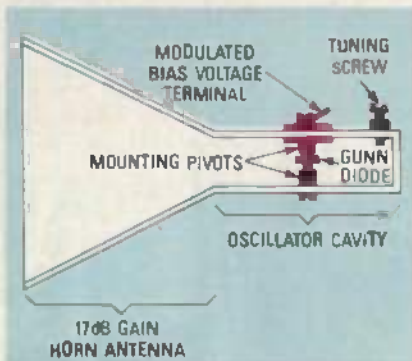

FIG. 2—THE HEART OF A RADAR SPEED-GUN used by the police, and others, or a radar false-target generator is a microwave Gunn diode. Here, the proper way to mount such a diode in a microwave horn is shown.

As shown in Fig. 2, the heart of a radar speed-gun—and our radar calibrator—is a Gunn diode oscillator. Typically these oscillators can generate an output level of about 100 mW. With that output level, and with a highly directional transmitting antenna, the range of a radar speed-gun is about 1/2 of a mile.

Until recently, high-output Gunn diodes were expensive; most cost several hundred dollars or more. Now, however, a Gunn diode can be obtained for as little as \$60. That certainly makes it attractive to hobbyists for experimentation.

How the calibrator works

Our circuit generates a false target that can be used to calibrate radar speed-guns.

WARNING

This radar calibrator may interfere with police radar, CB units, radio receivers, etc., up to 1000 feet away. Thus its use should be restricted to laboratory use or for educational, scientific, informational, or calibration purposes. The illegal use of a transmitter can subject the user to a \$10,000 fine, a jail term, and the seizure of transmitting equipment.

such as those used to time the speed of a baseball player's throw. Let's examine Fig. 3 to see how the calibrator can be made to force a speed gun to read a desired speed. As is shown in Fig. 3-a, the outgoing reference transmission and the incoming reflected transmission are both present inside the antenna cavity. Because, as described earlier, they are of slightly different frequencies, they interfere with each other in such a way that a difference signal (at a beat frequency) is created. That signal is detected by a mixing diode, and the low-frequency beat that results is passed on to be analyzed.

To force a speed gun to read a particular speed, all a false-target generator need do is to produce a difference signal that simulates the one that would be created by an object travelling at a certain speed. See Fig. 3-b. Assuming the output-power level is sufficient, it will "capture" the receiver, preventing it from detecting any other signal that might be present, including the Doppler-shifted reflection.

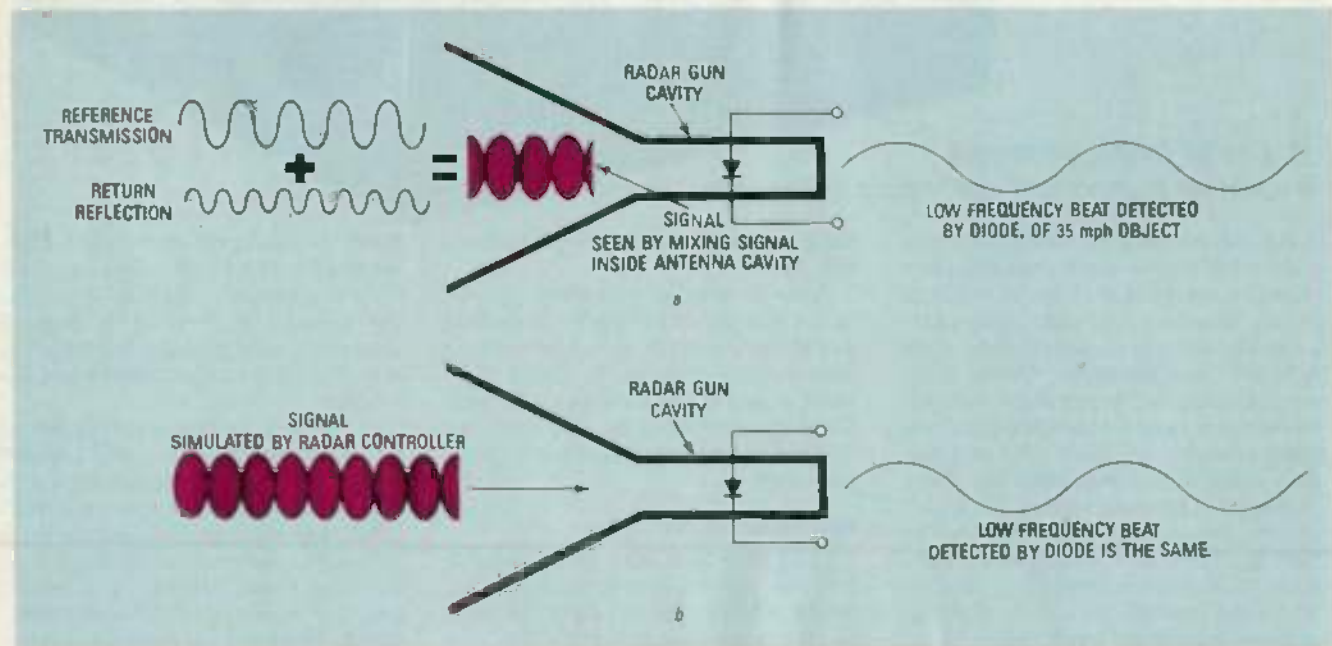

FIG. 3—WHEN THE TRANSMITTED AND REFLECTED SIGNALS are mixed in the horn's cavity, the resulting low-frequency beat can be used to determine the speed of the reflecting object, as shown in a. The calibrator works by generating a signal that simulates the one that would result if the transmitted signal were reflected by an object moving at a specified speed, as shown in b. As a result, the low frequency beat detected by the diode is the same as the one in a.

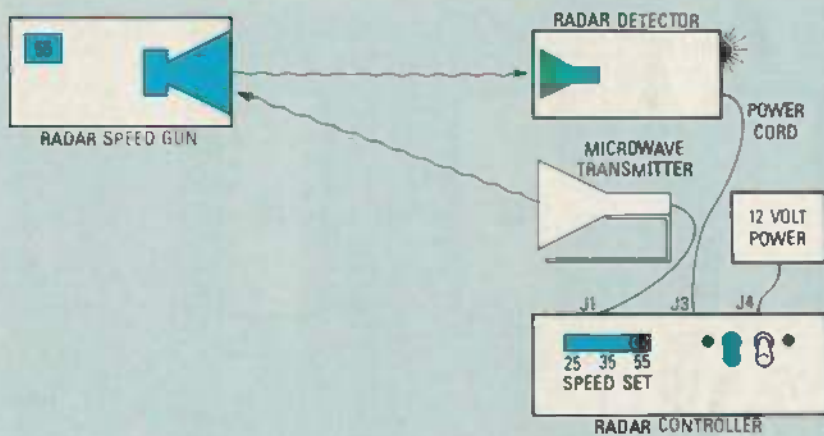

FIG. 4—USE THIS SET-UP to calibrate a radar-speed gun. The speed gun can be forced to read 25, 35, or 55 miles-per-hour by altering the setting of a switch on the calibrator.

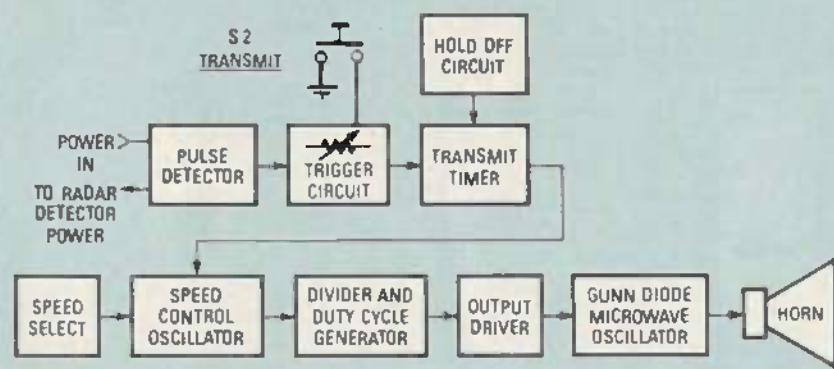

FIG. 5—THE RADAR CALIBRATOR is shown here in block diagram form.

Creating a difference signal that causes a speed gun to read a desired speed is not difficult. It's done by pulsing a carrier whose frequency is in the passband of the speed gun's receiver. Speed is simulated by varying the pulse rate. That is, the pulse rate is set at 31.4 pulses-per-second per mile-per-hour of desired reading. For a desired reading of 55 miles-per-hour the pulse rate would be $31.4 \times 55 = 1727$ pulses-per-second.

The basic set-up for calibrating a radar gun is shown in Fig. 4. A block diagram of the false-target generator is shown in Fig. 5. Note that the false-target generator is designed to work in conjunction with an automotive radar detector. The radar detector is used to make the operation of the calibrator almost automatic. When the radar detector senses a transmission from a speed gun, it sounds a buzzer or turns on a light as a warning. In doing that, the detector draws more current than normal from its 12-volt power source. The false-target generator's pulse-detector circuitry detects that surge, amplifies it, and, via the trigger circuit, triggers the transmit timer. The timer turns on the speed-control oscillator for approximately ten seconds. Using such a short transmission time is necessary to keep the Gunn diode from overheating.

A manual TRANSMIT switch (S2) is included for those not wanting to use a radar detector to trigger the Gunn oscillator. The switch is a momentary type, and it also triggers the one-shot for ten seconds.

The speed-control oscillator drives a divider network that generates the appropriate frequency and duty cycle for the output driver, which supplies voltage to the Gunn-diode oscillator. After ten seconds the transmitter timer locks itself off for a couple of seconds to give the radar detector time to settle down and reset.

About the circuit

The schematic diagram of the calibrator is shown in Fig. 6. Power is applied through J4. Power switch S1 applies power to the internal circuit through IC6, an LM317 voltage regulator; power is also applied to J3, the V_{OUT} jack, through R2, a 1-ohm sensing resistor. The voltage drop across R2 is amplified by Q1, which is slightly forward biased by R16; the TRIGGER SENSITIVITY control. Transistor Q2 amplifies the trigger signal and applies it to pin 5 (the trigger input) of one half of IC2, a 4538 dual timer. That half of the timer package is configured as a one-shot with a period of about ten seconds.

The period of the other half of IC2 is determined by C3, R19, and R11. The

PARTS LIST

All resistors 1/2-watt, 5%, carbon film unless otherwise noted

R1—4700 ohms
 R2, R24, R25—1 ohm
 R3, R10—10,000 ohms
 R4, R21—2200 ohms
 R5—2000 ohms, 1%
 R6—6650 ohms, 1%
 R7—4420 ohms, 1%
 R8—2210 ohms, 1%
 R9, R15, R22, R23—1000 ohms
 R11—1 megohm, trimmer potentiometer
 R12, R18, R19—100,000 ohms
 R13—1 megohm
 R14, R17—47,000 ohms
 R16—5000 ohms, trimmer potentiometer
 R20—270 ohms

Capacitors

C1—C5—10 μ F, 25 volts, electrolytic
 C6, C7—0.1 μ F, ceramic disk
 C8—470 pF, 5%, 100 volts, mylar
 C9—0.0047 μ F, 100 volts, mylar

Semiconductors

IC1—555 timer
 IC2—4538B dual precision timer
 IC3, IC4—4522B decimal divide-by-N counter
 IC5—4518B dual synchronous divide-by-10 counter
 IC6—LM317 voltage regulator
 Q1—2N3906 PNP transistor
 Q2, Q3—2N3904 NPN transistor
 Q4, Q5—TIP120 NPN power transistor
 D1—1N4004
 D2, D3—1N4148
 D4—MA49159, Gunn diode
 LED1, LED2—Red LED

Other Components

S1—DPDT, 3 amps, 110 volts
 S2—SPDT, momentary toggle
 S3—DP4T, slide switch
 J1, J2, J3—3.5 mm phone jack
 J4—2.1 mm phone jack

Miscellaneous: PC board, hardware (7 each—4-40 screws, 3 each—4-40 nuts), microwave horn, case, wire, solder, etc.

The following are available from Microwave Control, 1701 Broadway, Suite 236, Vancouver, WA 98663. (1-260-693-6843):

Complete kit including tested Gunn diode, microwave horn, PC board, case, and all parts, \$169.50; tested Gunn diode, microwave horn, \$117.00; etched and drilled PC board, \$19.50. Please add \$4.50 for shipping and handling. Washington state residents add 7.4% for sales tax. Allow 4-6 weeks for delivery.

output of that timer, pin 9, is used to reset the first timer via pin 3. Trimmer R11 is used to adjust the hold-off time of the trigger circuit to prevent false retriggering. False retriggering can occur when the calibrator output-signal is detected by the radar detector, which in turn retriggering the calibrator. You will have to experiment with R11 to find the setting that will prevent false retriggering.

The output of the first half of the 4538, pin 6, is used to enable IC1, a 555 timer that's configured as an astable multivibrator. The oscillating frequency of IC1 is determined by R6, R7, R8, and C8. The

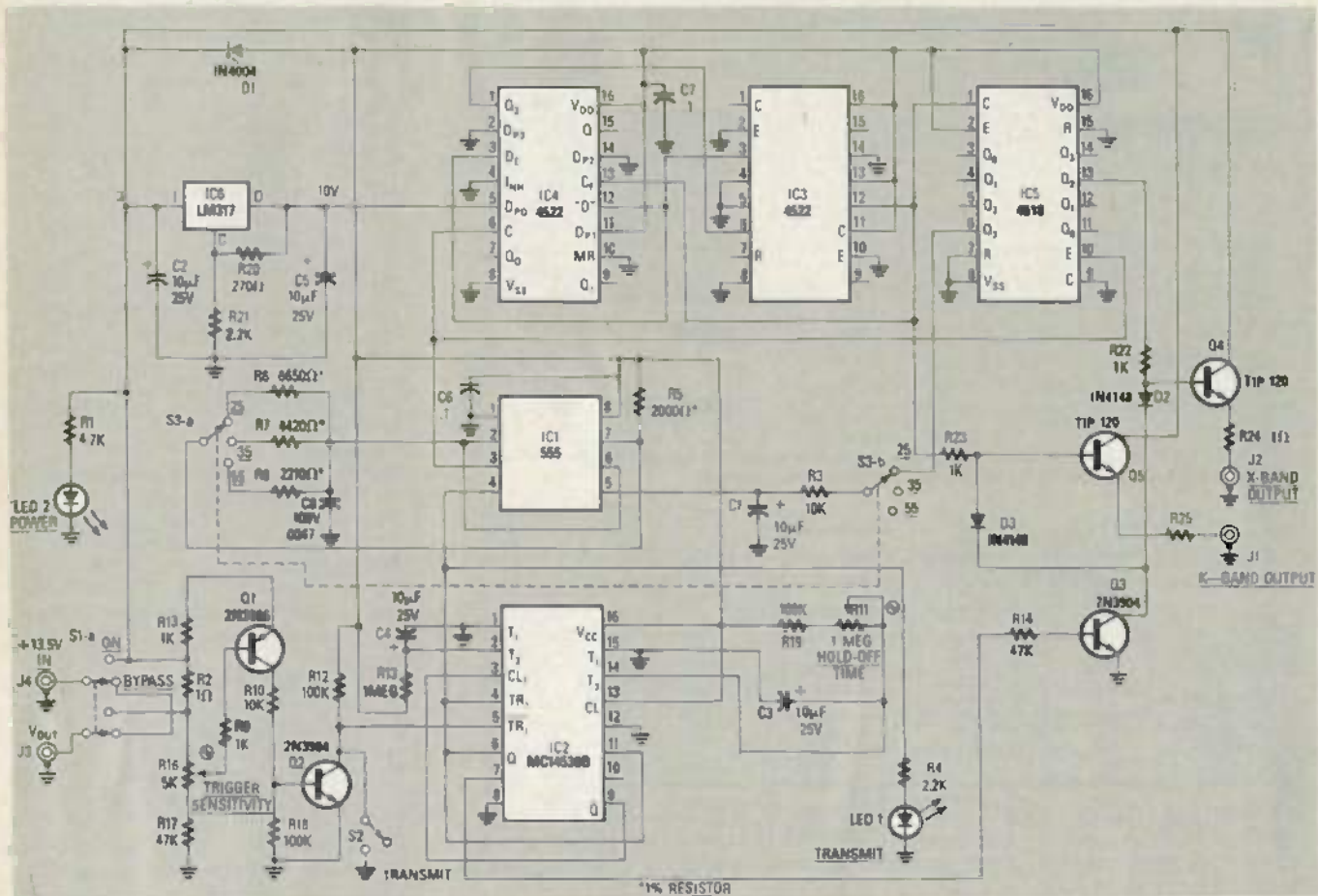

FIG. 6—ONE OUTPUT OF THE radar-calibrator circuit (J1 or J2) is fed to a Gunn diode mounted in a microwave horn. Outputs are provided for each of the two most popular speed-gun frequencies.

There are two outputs taken from the divider string. One, taken from pin 13 of IC5, is emitter coupled to J2, X-BAND OUTPUT, via driver transistor Q1. The 1-ohm resistor, R24, is included to ensure stability. The other output, taken from pin 13 of IC3, is emitter coupled to J1, K-BAND OUTPUT, via driver transistor Q2. A 1-ohm resistor, R25, is included to ensure stability. The J1 or J2 output, as appropriate, is applied to the Gunn diode. Although optional, and not shown in the illustrations, for best results a small, 0.47-pF mylar capacitor, C9, should be installed across the Gunn diode.

Diodes D2 and D3, in conjunction with transistor Q3, help ensure that the driver transistors remain off when the unit is not triggered. When switch S1 is at its slow speed settings, the output of IC5 is divided further and fed back through R3 and C1 to modulate IC1.

Building the unit

We recommend the use of a printed-circuit board. If you wish to etch your own, an appropriate double-sided layout is provided in our PC Service section. Also, you can purchase a board from the supplier mentioned in the Parts List.

continued on page 85

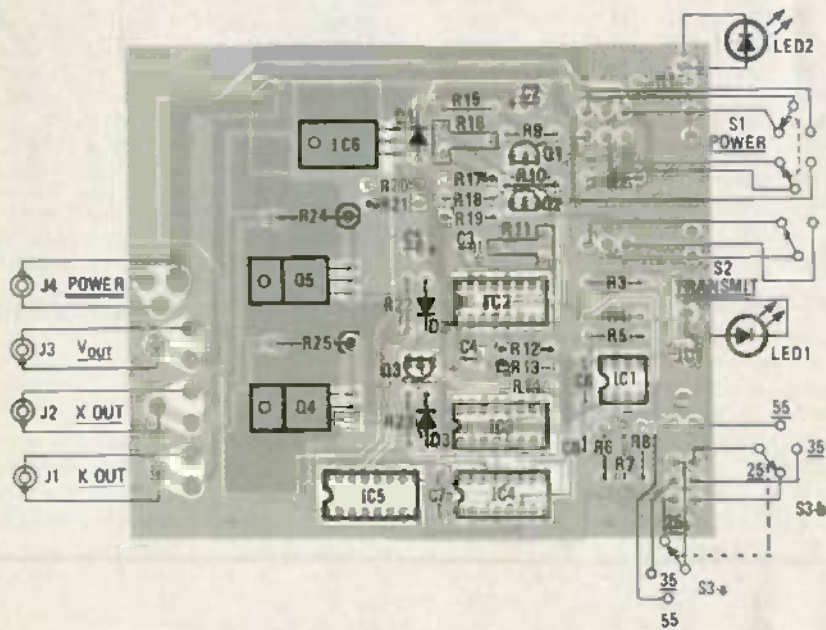

FIG. 7—THE CIRCUIT SHOULD BE MOUNTED ON a double-sided PC board. The patterns can be found in the PC Service section, of this magazine.

output of the oscillator drives the divider string consisting of IC4, IC3, and IC5.

The output from each divider is a square-wave with a 40% duty cycle.

Remote-Controlled Power Switch



DANIEL B. COOPER

Our infrared remote controller frees you from the tyranny of mechanical switches!

IT SEEMS A CRIME THAT SLEEK, SEXY stereos, VCR's and other electronic appliances must be operated by something so crude as a mechanical switch. There's really nothing wrong with a switch, but you must be within arm's reach to operate it. And when you're sitting comfortably in an easy chair and want to turn a TV, a stereo, or a lamp across the room on or off, it's mighty inconvenient to have to stand up, walk over to the device, and flip its switch.

Of course, if you're fortunate enough to own a remote-controlled TV or stereo, then you're partly free of the tyranny of mechanical switches. But what about radios, lamps, and the myriad of other devices that must be operated manually?

We've got the solution. The easy-to-build IR (Infra-Red) control system de-

scribed here can be built for under \$40. You can then control any device that draws as much as 1500 watts of power. The device can be 30 or more feet away.

Our controller consists of a very small (2 × 1½ by ½ inches) battery-powered transmitter and an AC-powered receiver that measures only 5½ × 3½ × 1½ inches. To use the controller, just plug the receiver into a wall outlet near the device you want to control, and then plug that device into the receiver. Then use the hand-held transmitter to turn the device on and off at your convenience. That's all there is to it!

How it works

The schematic diagram of the transmitter is shown in Fig. 1. As you can see, the transmitter is built around two CMOS 555

timer IC's (TLC555's). The TLC555 is quite similar to its bipolar cousin, but it requires less than 100 µA of supply current, and that's important when a circuit must be powered from a very small battery, as our transmitter is.

The transmitter generates a modulated 35-kHz IR signal. The 35-kHz carrier frequency is generated by IC2, and the 1500-Hz modulating signal is generated by IC1. The 1500-Hz output of IC1 appears as in Fig. 2-a; the modulated output of IC2 appears as in Fig. 2-b. An expanded view of each spike in that waveform is shown in Fig. 2-c.

The output of IC2 drives LED1 through resistor R5; that LED provides visual indication that the transmitter is working. In addition, IC2 drives transistor Q1, which in turn drives the two infrared LED's (LED2 and LED3).

The transmitter is powered by a miniature 12-volt battery, which is sometimes called a "lighter" battery from its use in electronically-ignited cigarette lighters. Although the battery supplies sufficient voltage for the circuit and is small enough to fit in a tiny case, it cannot directly source the high current needed to drive the two IR LED's. To provide that current, we pre-charge capacitor C6 and then dump all the charge it contains when S1 is pressed. When S1 is not pressed, power to the IC's is cut off. However, C6 is kept charged via R8. Then, when S1 is pressed, the current stored in C6 can be used to drive the LED's for as much as ½ second. That's plenty of time for the receiver to pick up a signal.

When C6's charge is exhausted, the

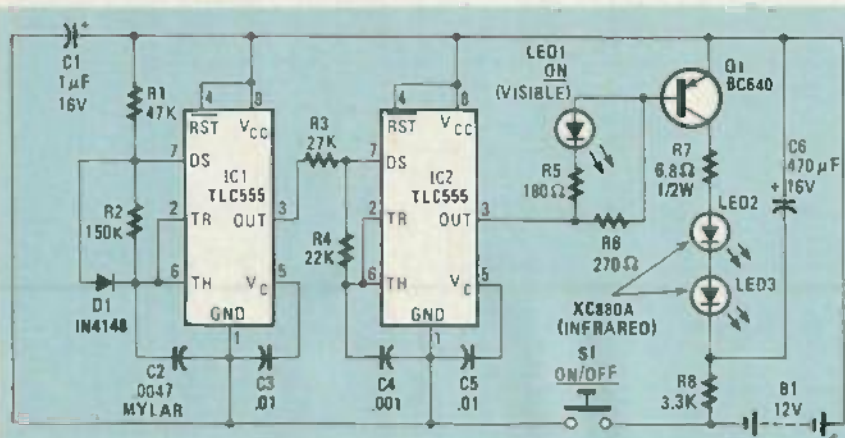

FIG. 1—THE TRANSMITTER IS BUILT AROUND TWO CMOS 555's that generate a modulated 35-kHz signal; that signal is transmitted by the two infrared LED's, LED2 and LED3.

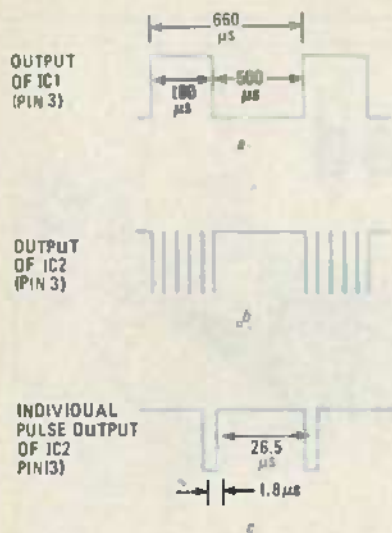

FIG. 2—THE 1500-Hz MODULATING SIGNAL is shown in a; the modulated 35-kHz carrier signal is shown in b; and one cycle of the 35-kHz bursts is shown in c.

output of the LED's drops to about one-third of their peak power. When S1 is released, C6 begins to recharge; it reaches 90% of capacity in about one second, and full capacity in five to six seconds.

At distances under ten feet, that charge time will be of no consequence because

at that distance, the receiver can pick up the reduced signal. At greater distances, though, it may be impossible for the receiver to respond twice in a very short period of time—less than about a second. But you should have no trouble if you wait for several seconds between each use of the transmitter.

The receiver

It is relatively easy to design an IR remote-control system, but most simple designs are hampered by either low sensitivity or high susceptibility to noise. The outstanding feature of our receiver is its high-sensitivity, low-noise input pre-amplifier, which is built around an μ PC1373 IR remote-control preamplifier (IC1 in Fig. 3).

The IC is contained in an eight-pin SIP (Single In-line Package), and it incorporates circuitry that not only conditions a signal from a photodiode, but also varies the bias on the diode to accommodate changing lighting conditions. The μ PC1373 also has a sensitive 30–40 kHz tuned detector, automatic gain control, a peak detector, and an output waveshaping buffer.

All that circuitry allows the weak signal picked up from photodiode D2 to be output as a clean, logic-level demodu-

lated signal; that signal is, in fact, an exact replica of the signal produced by IC1 in the transmitter!

The preamp stage is very sensitive to various forms of noise and RF interference, so, for maximum accuracy, the entire preamp circuit should be shielded and bypassed. Our PC-board layout, discussed below, has been optimized for low-noise performance.

The demodulated signal from the preamp stage is sent to IC4-a, a 74C14 Schmitt trigger. The squared-up 1500-Hz signal is then sent to the clock input of IC5-a, half of a 4013 dual "D" flip-flop. The flip-flop is configured as a binary divider, so the frequency of its output signal is exactly half the frequency of its input signal, but it has a duty cycle of exactly 50%.

That 750-Hz signal is clipped to approximately 0.7 volts p-p by diodes D3 and D4. The clipped signal is then fed to IC6, a 567 tone decoder. The output of that IC goes low whenever the frequency of the signal fed to it is within its lock range—the range of frequencies within which the IC will respond—of its internal VCO (Voltage-Controlled Oscillator).

The center of the VCO's lock range is set by components R16, R17, and C17. The trimmer potentiometer (R16) allows

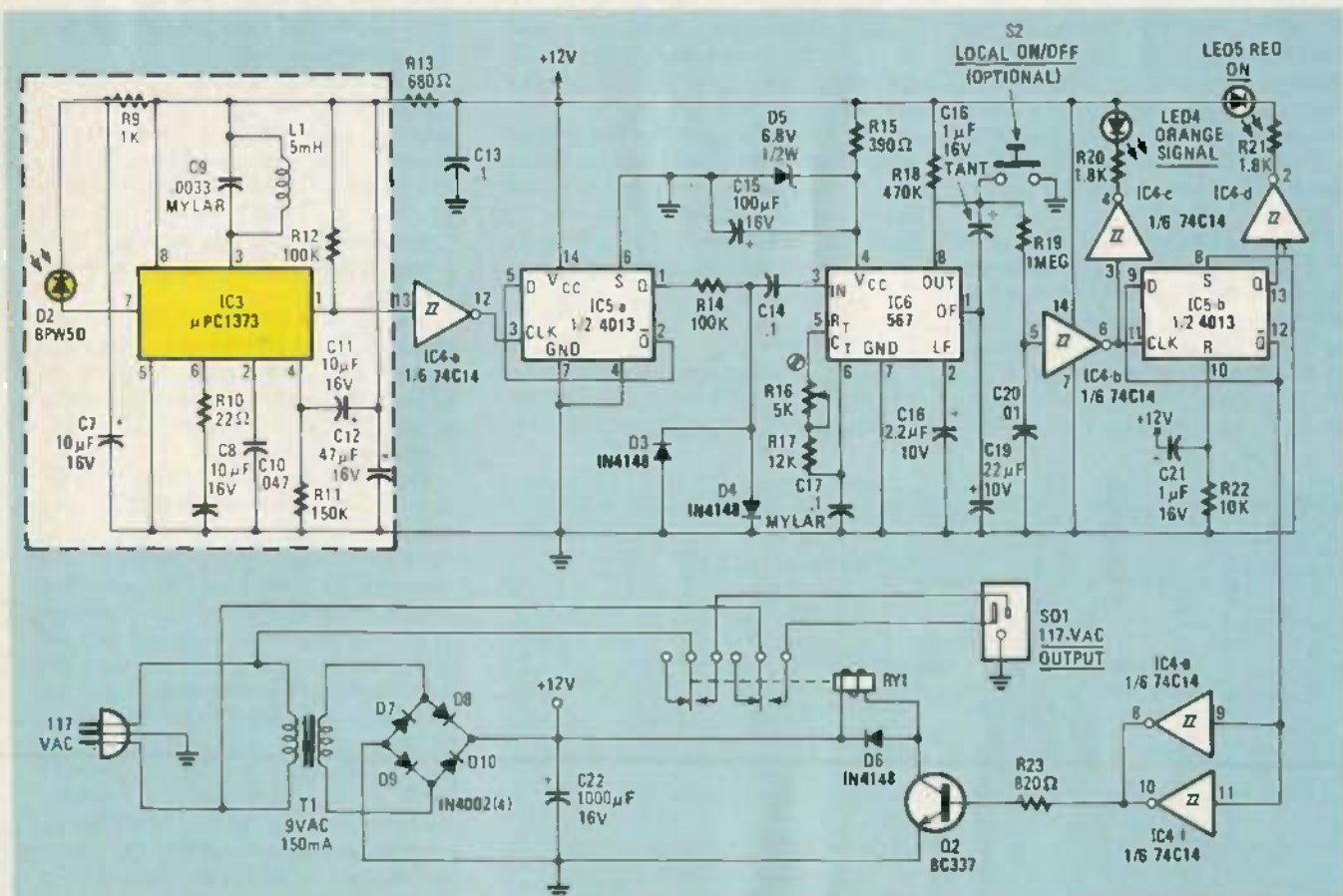

FIG. 3—THE RECEIVER FEATURES A SHIELDED PREAMP, shown here inside the dashed lines. The output of the preamp is squared up and fed to a PLL tone-decoder (IC6); the output of the PLL is fed through a bi-stable latch (IC5-b), which provides the ON/OFF function.

you to vary the center frequency to match the output of your transmitter. The lock range of the VCO is set by C18. We use a 2.2 μF capacitor here for a moderately narrow lock range—about 110 Hz. That provides an overall range of 750 Hz \pm 55 Hz. The length of time a signal of that frequency must be present to obtain output is set by capacitor C19; the 22- μF value sets that time at about 10 ms.

When IC6 detects a signal of the proper frequency, pin 8 goes low. Since that output is an open-collector transistor, a pull-up resistor (R18) is required for proper operation. The output signal is fed through another Schmitt trigger (IC4-b), which drives another "D" flip-flop, IC5-b. That flip-flop is configured as a bistable latch; each successive input causes the output to change state.

Schmitt trigger IC4-b also drives IC4-c, which in turn drives LED4. SIGNAL, which lights up whenever a signal is received. The Q output of IC5-b drives IC4-d, which in turn drives LED5, ON, which lights up whenever the output is in the on state. The \bar{Q} output of IC5-b drives two parallel-connected inverters, IC4-e and IC4-f; they turn transistor Q2 on when \bar{Q} goes low. That transistor energizes the relay; its contacts switch the device you're controlling on and off. Diode D6 is wired across the coil of the relay to suppress the reverse spikes generated by the coil whenever it is de-energized. Without D6, Q2 might be destroyed.

Components C21 and R22 are connected to the latch's R input; they provide a power-on-reset function. In other words, they ensure that the relay will be off when power is first applied to the receiver. At power-up, C21 is effectively a short circuit, so R is high. In that reset state, the Q output of the flip-flop is low, the \bar{Q} output is high, so Q2 and the relay are off. But, as C21 charges through R22, the voltage across C21 increases, and eventually the R input drops to ground and allows the IC to respond to input signals.

We have made provision for an optional LOCAL ON/OFF switch, S2. Since the 567 has an open-collector output, S2 can be used to force the inverter's input low and thus alternate the state of the latch without damaging the 567.

The receiver is powered by a nine-volt, 150-mA transformer that delivers about 12-volts DC after rectification by diodes D7-D10 and filtering by C22. Since most of the receiver circuit is voltage-independent, no regulator is used. However, the 567 requires a supply voltage less than nine volts. Therefore, resistor R15, capacitor C15, and Zener diode D5 are used to provide a regulated, filtered 6.8-volt DC source.

Construction

We recommend that you use PC boards, especially for the receiver, as the

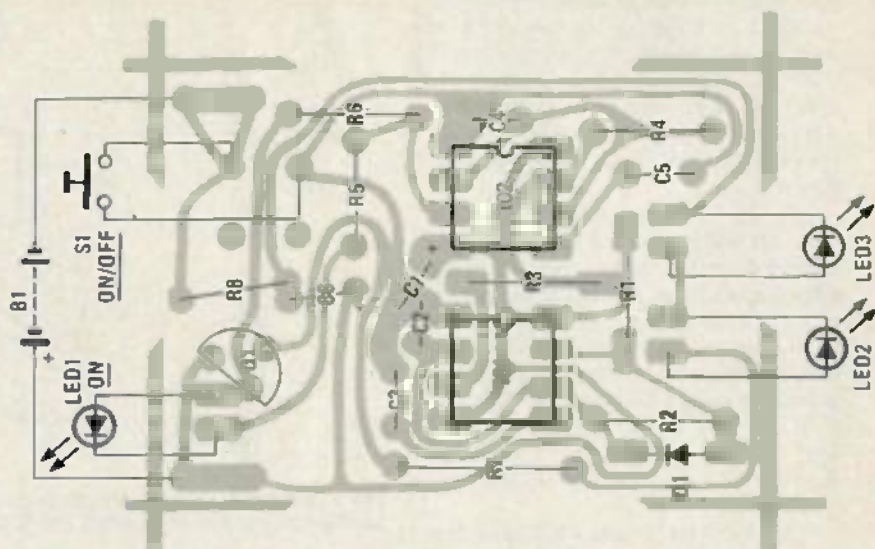

FIG. 4—COMPONENTS MOUNT ON THE TRANSMITTER BOARD as shown here.

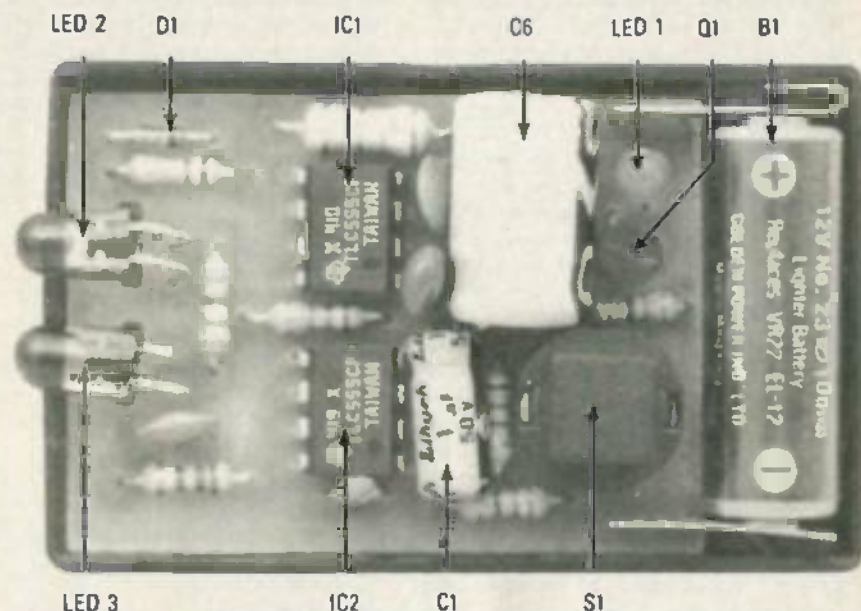

FIG. 5—THE COMPLETED TRANSMITTER appears as shown here. The legs of the electrolytic capacitors (C1 and C6) must be bent horizontally for those capacitors to fit in the case.

performance of its preamp can be degraded by improper layout. You can etch your own boards using the foil patterns shown in PC Service; pre-etched boards are included with the kits sold by the source mentioned in the Parts List.

When your boards are etched, inspect them for shorts and opens. Correct any problems and clean the boards with steel wool. Now build the transmitter. Install all components except the battery clips and the three LED's according to the diagram in Fig. 4. Take care to orient the capacitors, the IC's, D1, and Q1 correctly. As you can see in Fig. 5, the leads of C1 and C6 must be bent at a right angle; the capacitors are then mounted horizontally. The flat edge of S1 should face Q1.

Next solder the battery clips to the board. The bump on the negative clip should face inward, and the hook on the positive clip should face outward. Now

insert LED1 into its holes with the flat side toward the positive battery clip, but do not solder it in place yet. Lay the PC board in the top half of the case, adjust the position of the LED to line up with its mounting hole, and then solder the LED in place.

Now insert the two IR LED's (LED2 and LED3) into their holes with their flat sides toward the side of the board the negative battery clip is mounted on. Solder them in place about $\frac{1}{8}$ inch above the surface of the PC board. Carefully bend their leads so that they are parallel with the board and with each other, and so that the center of each LED is about $\frac{1}{16}$ inch above the surface of the board.

Lay the board in the lower half of the case and carefully mark where the center of each LED touches the front edge of the case. Remove the board and use a small ratchet file or a similar tool to cut out a precise half-circle for each LED. Check

your progress often to avoid overcutting.

Snap both halves of the case together without the board in place and mark where the edges of the holes meet the upper half of the case. Take the case apart and carefully file out the holes in the upper half to match those in the lower half of the case.

Now lay the board in the case. Then insert B1 and press S1; LED1 should remain lit for as long as S1 is pressed. If the LED doesn't light, make sure the battery is inserted correctly. If it is, use a frequency counter or an oscilloscope to verify that both TLC555's are oscillating. If they are, make sure that LED1 is mounted correctly. If you still haven't isolated the problem, you may have installed Q1 incorrectly, or you may have installed Q2 by mistake.

When the board is debugged, complete assembly of the transmitter. Insert the board into the lower half of the case and then snap both halves together. If desired, the IR LED's can be pushed back into the case so that they do not protrude.

Building the receiver

Since the components are not so closely spaced, building the receiver is somewhat easier. Referring to Fig. 6, solder all electronic—not mechanical—components to the board, except for LED4, LED5, D2, and T1. Be careful to orient all polarized devices correctly; IC3 should be mounted with the bevel oriented toward the transformer. Don't forget to solder the jumpers in place.

Bolt T1 to the board with its secondary wires toward C22. Keeping the leads as short as possible, solder the primary and the secondary wires to the appropriate pads. To prevent shorts, ensure that all strands of each wire pass through its hole. Clip off and insulate the transformer's center tap.

Solder three 3-inch pieces of 18-gauge wire to the output pads near the relay. Connect the opposite ends of those wires to the appropriate terminals on SO1.

Now solder D2 in place with its base about 1/8 inch above the surface of the board and with the beveled corner toward the center of the board. Mount LED4 and LED5 with their flat sides facing each other; the center of each LED should be about 1/4 inch above the board. The LED's will be parallel to the board and to each other if they are mounted correctly.

Now solder four thick pieces of bus wire to the four holes where the shield will mount. The shield can be bent as shown in Fig. 7 from a thin piece of tin. Also, cut a 1/2" x 1 1/2"-inch piece of tin plate for the bottom of the PC board. However, don't solder either shield in place until you have verified that the preamp circuit works exactly as intended.

Strip the sheath of the AC cord so that one inch of each conductor protrudes:

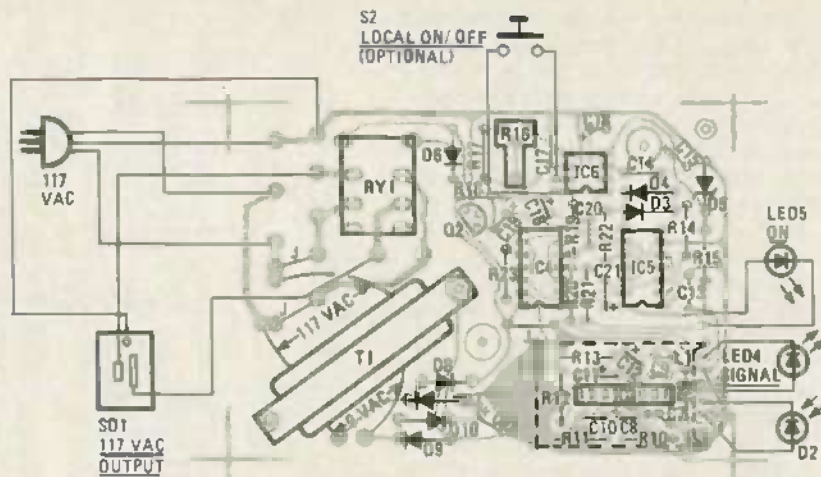

FIG. 6—COMPONENTS MOUNT ON THE RECEIVER BOARD as shown here. One shield must be soldered to each side of the board after testing confirms that the preamplifier works.

strip, twist, and tin 1/4 inch of each conductor. Pass the cord through the rear panel, insulate it with a grommet, and solder the leads to the board. Then press SO1 into the rear panel and solder the three wires to

the correct terminals. Your receiver should resemble the one shown in Fig. 8.

Now insert the red plastic IR filter into the front panel so that its legs are horizon-

continued on page 84

PARTS LIST

All resistors are 1/2-watt, 5% unless otherwise noted.

- R1—47,000 ohms
- R2, R11—150,000 ohms
- R3—27,000 ohms
- R4—2200 ohms
- R5—180 ohms
- R6—270 ohms
- R7—6.8 ohms, 1/2-watt
- R8—3300 ohms
- R9—1000 ohms
- R10—22 ohms
- R12, R14—100,000 ohms
- R13—680 ohms
- R15—390 ohms
- R16—5000 ohms, trimmer potentiometer
- R17—12,000 ohms
- R18—470,000 ohms
- R19—1 megohm
- R20, R21—1800 ohms
- R22—10,000 ohms
- R23—820 ohms

Capacitors

- C1—1 μ F, 16 volts, electrolytic
- C2—0.0047 μ F, mylar
- C3, C5, C20—0.01 μ F, ceramic disc
- C4—0.001 μ F, ceramic disc
- C6—470 μ F, 16 volts, electrolytic
- C7, C8, C11—10 μ F, 16 volts, electrolytic
- C9—0.0033 μ F, mylar
- C10—0.047 μ F, ceramic disc
- C12—47 μ F, 16 volts, electrolytic
- C13, C14—0.1 μ F, ceramic disc
- C15—100 μ F, 16 volts, electrolytic
- C16—1 μ F, 16 volts, tantalum
- C17—0.1 μ F, mylar
- C18—2.2 μ F, 10 volts, electrolytic
- C19—22 μ F, 10 volts, electrolytic
- C21—1 μ F, 16 volts, electrolytic
- C22—1000 μ F, 16 volts, electrolytic

Semiconductors

- IC1, IC2—TLC555, CMOS 555 timer
- IC3— μ PC1373, IR photodiode pre-amplifier
- IC4—74C14, hex Schmitt trigger

- IC5—4013, dual "D" flip-flop
 - IC6—567, tone decoder
 - D1, D3, D4, D6—1N4148, signal diode
 - D2—BPW50, infrared photodiode
 - D5—1N5526A, 6.8-volt, 400-mW, Zener diode
 - D7—D10—1N4002, rectifier diode
 - LED1—visible miniature red LED
 - LED2, LED3—XC880A, infrared LED
 - LED4—visible miniature orange LED
 - LED5—visible miniature red LED
 - Q1—BC640 (ECG383)
 - Q2—BC337 (ECG159)
- Other components**
- B1—12-volt miniature "lighter" battery
 - RY1—relay, DPDT, 10-amps, 12-volts
 - L1—5 mH inductor
 - S1—miniature SPST momentary push-button
 - S2—miniature SPST momentary push-button (optional)
 - T1—9-volt, 150-mA, PC-mount transformer

Note: The following kits and components are available from Dick Smith Electronics, P. O. Box 8021, Redwood City, CA 94063: Complete receiver including all parts, case, and mounting hardware, no. K-3428, \$32.00; transmitter including all parts, case, but less battery, no. K-3429, \$7.95; transmitter battery, no. S-3335, \$1.19; receiver case, no. H-2503, \$5.95; transmitter case, no. H-2497, \$1.95; \$2.50; BPW-50 IR photodiode, no. Z-1956, \$2.50; μ PC1373 IR photodiode pre-amplifier, no. KZ-6174, \$2.50; twelve-volt relay, no. S-7200, \$4.95; nine-volt transformer, no. M-2840, \$2.50. All orders must add \$1.50 plus 5% of total price for shipping and handling. California residents must add 6.5% sales tax. Orders outside the U. S. must be in U. S. funds and add 15% of total price.

ROUND UP

Part 2 WITHOUT A DOUBT, POCKET-TV has become one of the hottest segments of the consumer-electronics marketplace. It can also be a bewildering one, with manufacturers offering different technologies, different features, and a wide variety of price points.

Last time, we presented an overview of the market in tabular form. While that type of overview is useful for comparing all of the TV sets at a glance, there is quite a bit of information that cannot be presented in a table. This month, we'll take a deeper look at the best, and the worst, that those TV sets have to offer.

Our evaluations

All the manufacturers covered in this survey provided one or more sets for our evaluation.

However, some sets were not available at the time this report was written. Untested sets are noted (see Table 1 in the July issue of *Radio-Electronics*) and our comments on those are based on manufacturer's literature or our experience with sets that are similar.

All testing was conducted in a hilly suburb of Los Angeles, where TV reception is less than ideal, and normally requires an outside antenna, especially for low-band VHF channels (Channels 2 through 6).

The instruction manuals that came with each set varied from barely adequate (Sinclair) to excellent (most of them). All sets included a warranty of some type.

Casio

The TV-21 is the smallest, and the poorest per-



Pocket Television Receivers

FRED BLECHMAN

Here's a no-punches-pulled look at pocket TV, one of the hottest segments of the consumer-electronics market.

forming set we tested. To operate the unit, you flip up a panel that contains the LCD display and a translucent back panel. Light penetrating the back panel (together with the setting of the brightness control) determines image contrast. The screen image is reflected by a mirror, giving the effect of a screen tilted for easy viewing.

An optional backlight clips onto the back of the flip-up screen. Powered by the set's batteries, it contains an electroluminescent panel for use when the ambient light is not sufficient.

To keep the size of the unit small, Casio provides no speaker or retractable telescoping antenna. Instead, an earphone is provided; its wire lead doubles as the set's antenna. With that arrangement, if you move while watching, the earphone-lead/antenna whips around and the picture becomes unstable.

Another choice made in the interest of user simplicity (and to eliminate a tuning dial) is the incorporation of automatic signal-seeking for channel selection. When you turn on the set by selecting either VHF or UHF, a small black cursor appears at the top right side of the screen and starts moving downward, seeking a signal. Up-arrow and down-arrow buttons, marked AUTOTUNING, let you change cursor direction. When a signal is found, the cursor stops, and the picture and sound (usually) lock in. The picture quality, at best, is like a very bad newspaper photo.

The trouble with the automatic tuning is that the set does not discriminate well enough between good and bad signals. It will even lock in on scrambled subscription-TV signals, commonly found on the UHF band. On weak channels, it sometimes locks-in in such a way that video can be seen but sound can not be heard. Since the unit lacks a fine-tune control, there is no way to tweak up reception. Furthermore, the search for the next channel is very slow. Worst of all, if you move the earphone wire and the signal level drops, the set unlocks and starts searching for another channel!

That set, which appears to be identical to Radio Shack's *Pocketvision-2*, might be adequate in a strong signal area, and for watching at a desk where the antenna lead will not be subject to much movement. It is probably great for watching daytime soaps at the office during lunch or break time.

The *TV-60*, not tested, appears to be a *TV-21* with an AM/FM radio added.

The *TV-1000* is an LCD color set with reasonably good performance. It has a built-in fluorescent backlight for indoor viewing. Outdoors you can drop down a reflective back panel to collect sunlight—and we mean sunlight, not just daylight, because that set requires quite a lot of illumination.

Screen viewing angle is restricted with that set. At anything other than the the

best viewing angle, the picture either gets dark or washes out. You can partially compensate for that by using the brightness control.

The color is fair, with a surprising degree of sharpness. Thumb-adjusted color and tint controls let you set the degree and shade of color to your liking.

The *TV-1000* also uses automatic tuning, but the tuner appears to be much more sensitive, and a regular telescoping whip antenna is used. The result is a stable picture.



RADIO SHACK POCKETVISION-20

Video and audio inputs are provided, allowing for improved performance when used with a VCR. That also means that the unit could be used as a computer monitor, though because of the small screen size such use is likely to be impractical.

That unit is apparently identical to the Radio Shack *Pocketvision-20*.

The *TV-5000*, not tested, appears to be a *TV-1000* with an AM/FM-stereo radio added.

Citizen

The *037A* was one of the first decent LCD sets in the marketplace. Now discontinued, that small, slim set with a built-in AM radio remains available at discount prices at many stores.

Despite poor contrast, a common problem with LCD sets, that unit has much to recommend it. The picture is relatively large and surprisingly good, at least until you compare it with that produced by a CRT. The video input makes the set easy to use as a monitor. Included accessories include an AC adapter and a 3½-foot plug-in wire antenna.

The flip-up panel and mirror provide a comfortable viewing angle, the drum tuning dial is fast and easy to use, with clear markings, and slide controls for volume and brightness are well-marked and easy to set.

The *057A* color set is another story. The book-style carrying case is beautiful, and the set itself has a great look and feel. Its performance, however, leaves something to be desired. In fact, it was the poorest performing color set we evaluated; in fairness, it was also the least expensive. Indoors, the color picture is fair. But outdoors the picture becomes completely washed out; you almost have to use the

built-in backlight (which greatly shortens battery life), since it takes a lot of external light bouncing off a tilt-down back reflector to produce an acceptable picture, on the screen.

Reception is limited with the 2-foot telescoping whip antenna, but improves considerably with the 3½-foot clip-on wire antenna that is provided. The video/audio inputs allow you to monitor a VCR or camera indoors.

The *067A* and the *087A* were not available for testing. In those sets, Citizen claims to be using a special "black matrix" process that produces a screen with a



CITIZEN 067A

contrast ratio of 5:1 (compared with 2.5:1 for their earlier LCD sets, and 10:1 for a typical CRT screen, according to Citizen).

The *067A* is replacing the *037A*; it has a list price of only \$100. It is a little smaller than the *037A*, and has no radio, but it does have a higher pixel count and a smaller screen, which provides better resolution. With its combination of improved contrast and low price, that set could fast become an LCD favorite.

The *087A*, using a 3.5-inch screen with even greater pixel density, improved contrast, and an FM-stereo radio, also could be a winner.

Epson America

The *ELF ET-20* (and its Seiko equivalent, the *LDV012*) were, without question, the best LCD units tested. The resolution was remarkable for an LCD screen, with a brightness and contrast approaching that of a CRT.



EPSON ELF ET-20

The *ET-20* uses reflective LCD TFT (Thin-Film-Transistor) technology, so no backlight is required. Furthermore, an acceptable picture is produced with normal room lighting, and the picture does not fade outdoors. The unit is very small, easily fitting in a typical shirt pocket.

However, several design compromises were made that reduce the effective use of that set. Although the sound quality is good, the speaker is at the back, so all sound projects rearward. Since the speaker is so small to start with, the *ET-20* only has sufficient volume for viewing in a quiet area. Making things worse, when an earphone was used, at least on the model tested, there was an annoying low hum. Also, the wire stand provided allowed the set to tilt too far back for convenient viewing. Perhaps that's why the Seiko version left the stand off altogether.

The color *ELF ET-12* has had a lot of favorable reviews—with good reason. The picture offers surprisingly good color, tint, contrast, and resolution. Brightness, color, and tint are adjustable to your liking. The relatively large front-mounted speaker provides good sound.

The picture is watchable outdoors, but is better inside. A reflective panel tilts down from the back for use in locations where the lighting is sufficient. Otherwise, the built-in fluorescent backlight provides sufficient illumination.

Magnavox

The *BF390/BK* is an exceptional set in almost every way. It appears to be identical to the *Sony FD-30A* (we'll get to the *Sony* sets in a moment).

The specially-designed *FD* (Flat Display) CRT's picture resolution and contrast are excellent. For even better video quality, a video input is provided (however, there is no audio input); surprisingly, an 80-column computer display was readable. The video input also will allow the unit to be used as a video-camera or portable-VCR monitor. The front-mounted speaker and stereo headset provide good sound.

Since the unit is a CRT set, no external source of light is needed. The best viewing conditions are indoors, with subdued room lighting. Outdoors your eyes become adjusted to the ambient lighting and the picture appears washed out. Direct sunlight on the screen washes the picture out altogether. That's why the carrying case is designed with two flaps: those flaps are held in position with Velcro tabs to form a sunhood for outdoor viewing. The set includes a swing-out stand.

The tuner is about as sensitive as those of most of the other sets tested. There is no provision for an external antenna.

The *BF390/BK* was not tested, but appears to be the same as the *BF390/BK* except for an AM/FM-stereo radio; we assume that its performance is compara-

ble. It does not have a video input and is not supplied with an earphone.

Panasonic

The *TR-1030P*, and its sister *CT-101* (more on that in a moment), both use a conventional-design CRT that has the smallest screen size of any of the units in this report. Despite that, the sets are among the largest reviewed. To accommodate the long neck of the CRT, the tube was positioned so that the screen is viewed at what would normally be one of the side panels.

We're impressed with the *TR-1030*. Although the screen is small, the display is clear and bright. An included magnifier is a worthwhile accessory. Although there is no external antenna input, the tuner has better sensitivity than most of the sets and provides a clear picture even on the weaker channels. The fact that it comes with rechargeable batteries and an AC adapter/charger is also a definite plus. (Note that the charger uses a special plug; that makes it impossible to plug the wrong charger/adapter into the TV set.) In fact, all accessories, including a cigarette-lighter adapter (for car use) and earphones, are included.

Our reaction to the *CT-101* color set was similar. The color, brightness and contrast of that CRT set were far superior to those of any other color set reviewed.

All accessories are included. Among those are a magnifier, an AC adapter/charger, rechargeable batteries, headphones, an audio/video patchcord, and a car cord. Panasonic even includes a matching transformer to allow you to connect either 300-ohm twin-lead or 75-ohm coaxial cable to the antenna input. At a list price of \$450 the *CT-101* is the most expensive set in this report, but you get what you pay for.

Radio Shack

The *Pocklevision-2* is similar to the *Casio TV-21*. It differs in that the case and backlight are included; batteries are not included.



CASIO TV-1000

The *Pocklevision-3* (not tested) at first appears to be similar to the *Citizen Q3TA*, without the radio, AC adapter, or a video input, but with a backlight. However, *Citizen* claims that the unit they build for Radio Shack "uses a black screen rather

than a white screen, giving better contrast, but a sepia-toned picture."

The *Pocklevision-20* (not tested) appears to be the same as the *Casio TV-1000*, but it includes a wire antenna and doesn't include batteries.

Seiko (Hattori)

The *Seiko LDV012* differs from its sister *Epson ET-20* only in cosmetic details—it has batteries but no stand, and is turned on by pulling down a screen cover (there is no conventional on/off switch).



SEIKO LDV-012

The *LDV202* is a color LCD set with a good picture and a built-in LCD alarm-clock module. That module slips out of the case and has its own battery. That set is the smallest of the color sets tested, and worked very well. The screen tilts up to allow light to bounce off a silver reflector to the back of the screen. Typical room lighting appears to provide sufficient illumination. It works well outdoors in the daytime, and for night (or dark room) viewing, a backlight is included. The backlight, which normally draws power from its own batteries, simply snaps onto the back of the screen. When using the AC adapter or car cord, a small included patchcord connects the external power source to the backlight.

Sinclair

Sinclair's Flat Screen TV, available in England for over a year, was recently in-



INSIDE THE Sinclair FTV2. That set uses a flat-screen CRT display.

roduced in the United States as the *FTV2*. Because the unit had to be redesigned for use in this country (the British do not use the U.S. VHF frequencies), its performance is markedly better on UHF channels (although its VHF performance is certainly adequate).

The flat-screen CRT produces a very

good picture, though it is not as good as the one produced by the Sony/Magnavox TV sets. Further, it is the least expensive miniature CRT-type TV set available.

We should note that this set does not use alkaline cells for power. Instead it requires a flat Polaroid *Polapulse* lithium battery. That P-500 version of that battery, which is included, can power the unit for up to 15 hours. The P-100 version of the battery, which is available at many hobby stores, will run the set for 2 hours. Unfortunately, those batteries are not rechargeable and are not inexpensive; Sinclair offers a package of three of the P-500's for just under \$10.

The only accessories provided with the *FTV2* are a thin vinyl slip-over case and an earphone. No handstrap is provided or available.

Sinclair does not sell an AC adapter in the U.S. for the set, but you can use the Radio-Shack *Universal AC-to-DC Adapter* (Cat. No. 273-1650). For car use, you'll want the Radio-Shack *Universal DC Auto Adapter* (Cat. No. 270-1560).

The set is generally a good value but does suffer from some deficiencies, mainly poor sound from the small side-mounted speaker, and inaccurate dial markings. It can also be difficult to obtain locally. If you run into trouble, the set is available from a few mail-order dealers. One such dealer is Curry Computers, 5344 West Banff, Glendale, AZ 85312-5607.

Sony

The Sony *FD-2A* and *FD-30A* use the same 2-inch FD flat CRT as the Magnavox units mentioned earlier. Therefore, it's not surprising that the picture quality of both sets is just as good as that of the Magnavox units.

The *FD-2A* is the only set tested that allows the reception of TV sound without picture, for greatly extended battery life. A rechargeable battery pack is not available, but you can use individual rechargeable cells (penlight type).

The small front-mounted speaker produced fair sound; no earphone is supplied with the unit. Contrast levels (low, medium, or high) are selected using a three-position switch. There is a separate rotary brightness control. There is no video input but there is an external antenna input. The carrying case that comes with the unit is simply an unpadded silver-color bag with a drawstring at the top.

The *FD-30A* is essentially identical to the Magnavox *BF3901BK*. The *FD-30A*, however, comes with batteries and Sony offers a number of optional accessories not offered by Magnavox (note that those will also work with the *BF3901BK*). Among those accessories are an external battery case (which uses four C-size alkaline cells for about ten hours of operation), higher quality stereo headphones

than those supplied with the set, a speaker system, a video-camera monitor cable, and a screen magnifier.

The *FD-40A* uses a large 4-inch diagonal flat-display CRT. It is stretching a point to call that set a "pocket TV," but is included here for those whose interest is in the ultimate in portable monitors. For such applications, that set (and its Zenith clone, the *BT044S*, which we will get to next) may be the most practical choice.

The *FD-40A* screen seems enormous when compared with that of the other sets tested for this report, and it was a pleasure to watch. No stand is required; the base of the unit is wide enough for the unit to stand by itself. The screen is located near the bottom of the unit and is slanted for comfortable viewing from about 2½ feet away. The relatively large speaker produces good quality sound; no earphone is included.

On the down side, the image produced did not seem as sharp as that produced by the other Sony sets, although that may have been due solely to the fact that the screen is larger. Also, the video/audio puts are non-standard and require the use of a special adapter cable that's not included; it is available as an option. Finally,

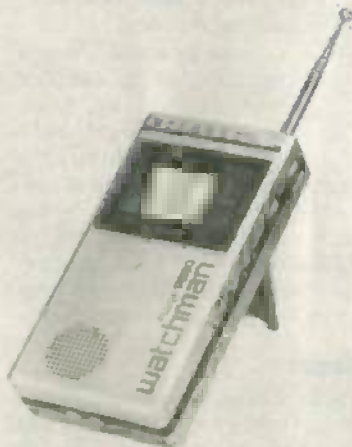

SONY *FD-30A*

the set goes through batteries at a fairly fast rate; no AC adapter is supplied.

Optional accessories include a rechargeable battery pack, car cord, earphone, external antenna connector, gutter-mounted car antenna, and roof-mounted car antenna.

Zenith

The *BT044S* is functionally identical to the Sony *FD-40A*, although there are some minor cosmetic differences. The unit comes with an AC adapter and an earphone, but no batteries or carrying case. Zenith does not offer many of the accessories offered by Sony, such as the rechargeable battery pack, but it appears

that those offered by Sony will work with the *BT044S*.



ZENITH *BT044S*

What was a bit surprising, especially considering the set's similarity to the *FD-40A*, was the poor quality of the picture—it was rather gray and fuzzy.

Summary

After testing all of the units, and examining the specifications and brochures of those not tested, we've formed some opinions about the units.

If you are interested in just having a pocket TV for occasional use, and want to keep the cost low, consider the Citizen *06TA* or Sinclair *FTV2*.

For a better picture, but also a higher cost, consider the Magnavox *BF3900BK* or Sony *FD-2A*. If you want to add stereo FM, get the Citizen *08TA*, the Sony *FD-30A*, or the Magnavox *BF3901BK*.

For monitoring video from a camera or VCR, the Sony *FD-40A* or Zenith *BT044S* will give you the largest picture. If you can get by with a smaller monitor, consider the Sony *FD-30A* or Magnavox *BF3901BK*.

If you can't get by without color, be prepared to pay a lot more for a lot less in picture quality. Of the color sets, the Panasonic *CT-101* is tops, followed by the Seiko *LDV202* and Epson *ET-12*.

In this report we've tried to fairly point out each TV set's strengths and weaknesses. Balancing those against your needs should lead you to the unit that's right for you. Also, the judgments presented here are the author's. Just as you would for any other type of electronics equipment, you should evaluate a set's performance for yourself before making a purchase.

R-E

CIRCUITS

TV SIGNAL DESCRAMBLING

This month we turn our attention to several practical descrambling circuits.

WILLIAM SHEETS AND RUDOLF F. GRAF

Part 3 NOW THAT WE'VE looked at the theory behind several possible scrambling systems and several systems now in common use, it's time to turn our attention to some real-world circuits. For the most part, we will confine our discussions to those systems using fixed scrambling algorithms. Those systems include gated-pulse, sine-wave, and Sync Suppression and Active Video Inversion (SSAVI). Although those systems are different, they do share some common circuits. Let's start off by looking at some of those common circuits.

Basic circuits

One simple circuit that crops up in a variety of scrambling/descrambling systems is the video clamping circuit. That circuit is used to establish a DC or base reference for a video signal.

Consider the situation shown in Fig. 1. There, the video signal shown in Fig. 1-a is fed to the "AC-coupled" network of Fig. 1-b. Note that the output waveform shown in Fig. 1-c follows the input, but that the DC level has shifted down about two volts. The result is that, for the portion of the waveform shown, the grays would appear white and the blacks would appear gray. Also, because of the suppressed level of the sync tips, the picture might roll.

The missing reference level can be re-established by modifying the network as shown in Fig. 2. A small portion of the signal is rectified by the clamp diode, D1, and appears as a DC bias that shifts the DC level automatically as required. Assuming that the diode is ideal, the video output can go no further negative than the reference voltage; the video signal is said to be "clamped" to that reference voltage.

Another circuit found in almost every descrambler is the modulator. In the simplest of terms, a modulator is a circuit that

Over the next few months, Radio-Electronics will be presenting a series of articles describing the techniques used by pay-TV and cable companies to scramble their signals. While specific circuits for specific scrambling systems will be discussed, they are presented for informational and experimental purposes only. Therefore, parts lists, parts suppliers, and additional technical support will not be available for those circuits.

superimposes one waveform on another. In a descrambler, the modulator is used to re-insert components of the video waveform that have been removed, or to restore components that have been altered.

In the gated-sync system, the effect of the scrambling is to reduce the amplitude of the sync pulses. That could also be looked at in another way: The video level is increased so that it is much too high for the sync pulse.

We could restore the proper signal either by reducing the video gain between sync pulses, or by increasing the video gain during the sync pulses. Ideally, we need a circuit that has different gain (or attenuation) for video and sync signals.

Two basic approaches can be used to restore the proper relationship between video and sync signals. One is to use a variable attenuator; the other to use a variable-gain amplifier. The choice of approach is pretty much up to the designer as either is practical and effective.

Variable attenuators

Figure 3 shows four different attenuator networks. The one shown in Fig. 3-a is a

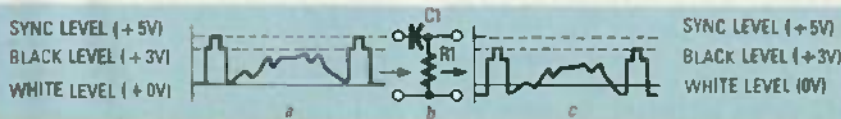

FIG. 1—WHEN A VIDEO SIGNAL is fed through an AC-coupled network, the DC reference-level is lost.



basic, fixed design. The circuits shown in Figs. 3-b and 3-c feature continuously variable attenuation. The transistor switched circuit of Fig. 3-d has an "on/off" attenuation characteristic. In that last circuit, Q1 switches R2 in to and out of the circuit. When the transistor is conducting, the attenuation is equal to $R1/(R1+R2)$. Of course, at other times it is less.

Note that, in all of the circuits of Fig. 3, R1 and C1 should be chosen so that the time constant that results is 0.1 second or greater. That will allow the circuit to pass the lowest-frequency video components. Typical values for R1 range between 20 and 150 ohms. For video applications, C1 ranges from 1000 to 5000 μF ; for RF it should be between 100 pF and 0.01 μF . The value for R2 should range from 5 to

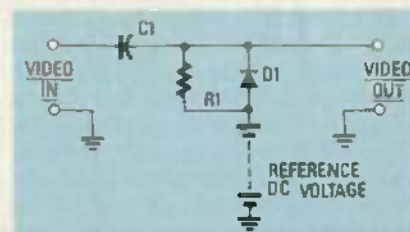

FIG. 2—THE DC REFERENCE-LEVEL can be re-established using a clamping circuit.

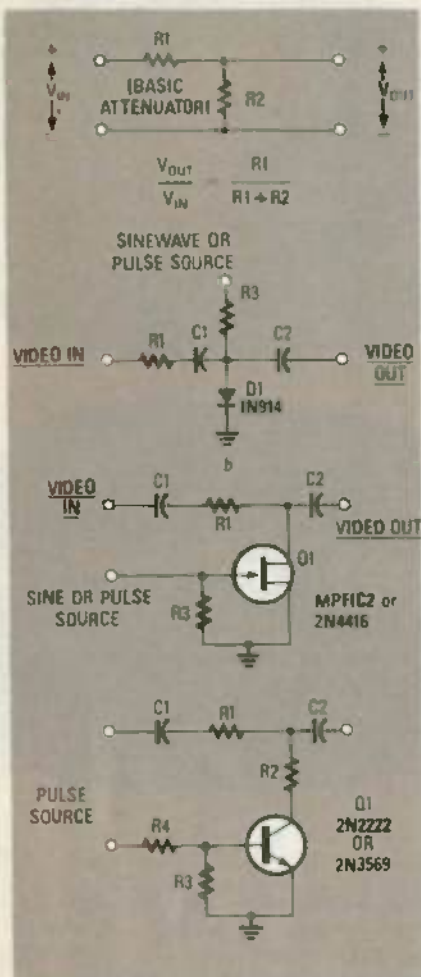

FIG. 3—FOUR ATTENUATOR CIRCUITS. A basic fixed attenuator is shown in a. The attenuators shown in b and c are continuously variable. The attenuator in d has an on/off operating characteristic.

50 ohms, while the values for R3 and R4 can fall between 1000 and 22,000 ohms.

Any of the variable attenuators could be used to restore the proper video waveform for a gated-pulse, sync-suppression, or video-inversion type of scrambled signal. However, because we need some degree of "linearity" to deal with sinewave encoded signals, the switched circuit of Fig. 3-d would not be appropriate to decode such signals.

Descrambling could be done either at the RF or video level, although it is perhaps simplest to do it at the RF level. That's because RF descrambling, either at broadcast VHF/UHF frequencies or the TV set's IF frequency (typically 45 MHz), allows the use of lower-valued, physically smaller capacitors (100 pF-0.01 μF vs. 1000-5000 μF).

All of the variable attenuators require that the active element be biased on (be conducting) during the periods when the video signal is present. The result, of course, is that the level of the video signal is reduced. During the interval when the sync signals are present, the active elements are biased off and attenuation is

reduced or removed so that the sync-signal level, blanking-pulse level, and colorburst signal are not affected. Biasing is provided by a pulse or sinewave source as appropriate. (In some cases, a pre-distorted sinewave is required; we'll look at that a little more deeply later on in this series.) The net result is that the normal relationship between the video and the sync levels is restored.

We can now look at our first, basic descrambler. It is shown in Fig. 4. That

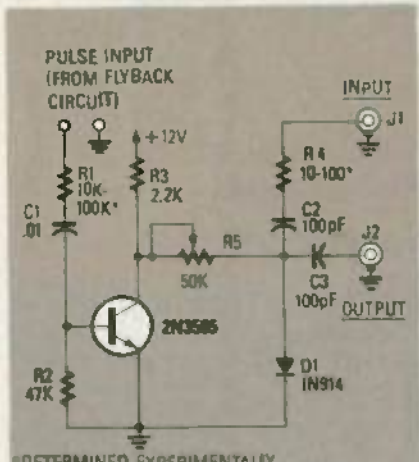

FIG. 4—THIS SIMPLE DESCRAMBLER is based on a continuously variable attenuator. Though difficult to align, it can be made to work.

circuit can be used to decode a gated-sync scrambled signal. It will not work on other types.

Let's see how that circuit works. A small sample of the flyback pulse is used to control the operation of Q1. As a result, during the scan interval the transistor is cut off, allowing a current of about 1 mA to flow from the power supply. That current biases D1 on. The impedance of the



FIG. 5—USE THIS SCHEME to derive the flyback pulse required by the circuit in Fig. 4.

diode is determined by the amount of current flowing through it. The amount of current, and thus the impedance of D1, can be controlled by varying R5.

During the retrace interval, however, Q1 is biased on by the flyback pulse, which must be positive. That diverts the current from the power supply to ground, removing the bias from D1.

The amount of attenuation that that circuit provides depends on the impedance of D1. During retrace, the diode is cut off and there is little attenuation. During scanning, attenuation takes place because D1 acts as a low resistance that shorts part of the signal to ground.

We've received reports that circuits similar to the one shown in Fig. 4 have been used to decode VideoCypher II video; as we have had no direct experience with that, we make no promises or guarantees. Further, neither that circuit, nor any other that we've heard of is capable of restoring proper audio to a VideoCypher-scrambled signal.

The circuit of Fig. 4 is not without its problems. It is difficult to adjust and noise prone. Also, it requires digging into the TV receiver to obtain the flyback pulse. On the other hand, it is a good experimental project because its parts are low cost and can, for the most part, be reused later in a more advanced descrambler.

Perhaps the most difficult aspect of getting the circuit working is obtaining the flyback pulse. Unless you know what you are doing, you could damage the TV set or expose yourself to dangerous high voltages. For those who would like to give it a try, Fig. 5 shows a method for obtaining the flyback pulse. Be sure to use heavily insulated wire and, if possible, operate the set from an isolation transformer during your experiments. Once again, you will be dealing with high voltages, so be extremely careful.

Variable-gain amplifiers

The other approach to restoring a video waveform is to use a variable-gain amplifier. In that approach, the gain of the decoding circuit is controlled by a decoding signal in such a way that the output consists of a proper video waveform. Two circuits that are appropriate for that ap-

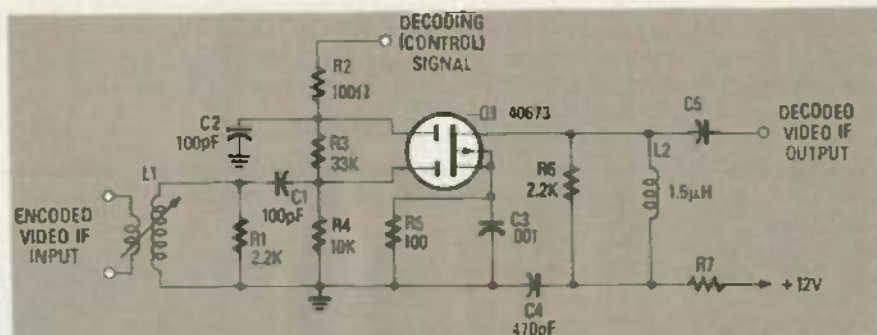

FIG. 6—THIS DESCRAMBLER is based on a variable-gain amplifier. The decoding signal is used to determine the amount of the gain.

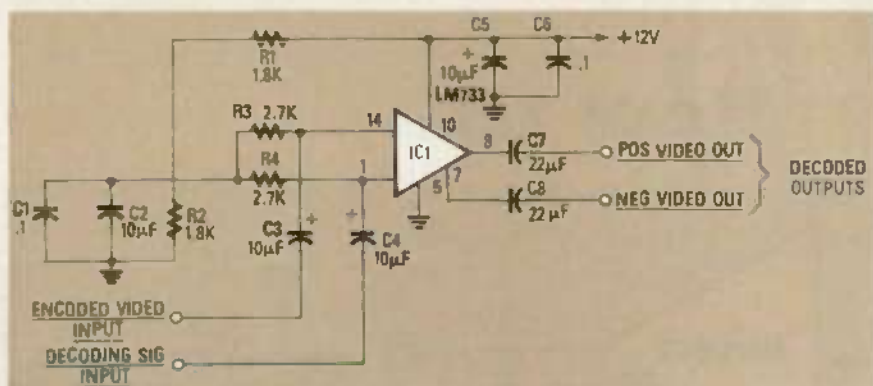

FIG. 7—ANOTHER VARIABLE-GAIN descrambler. This circuit is built around an LM733 video amplifier. Note that both positive and negative outputs are available.

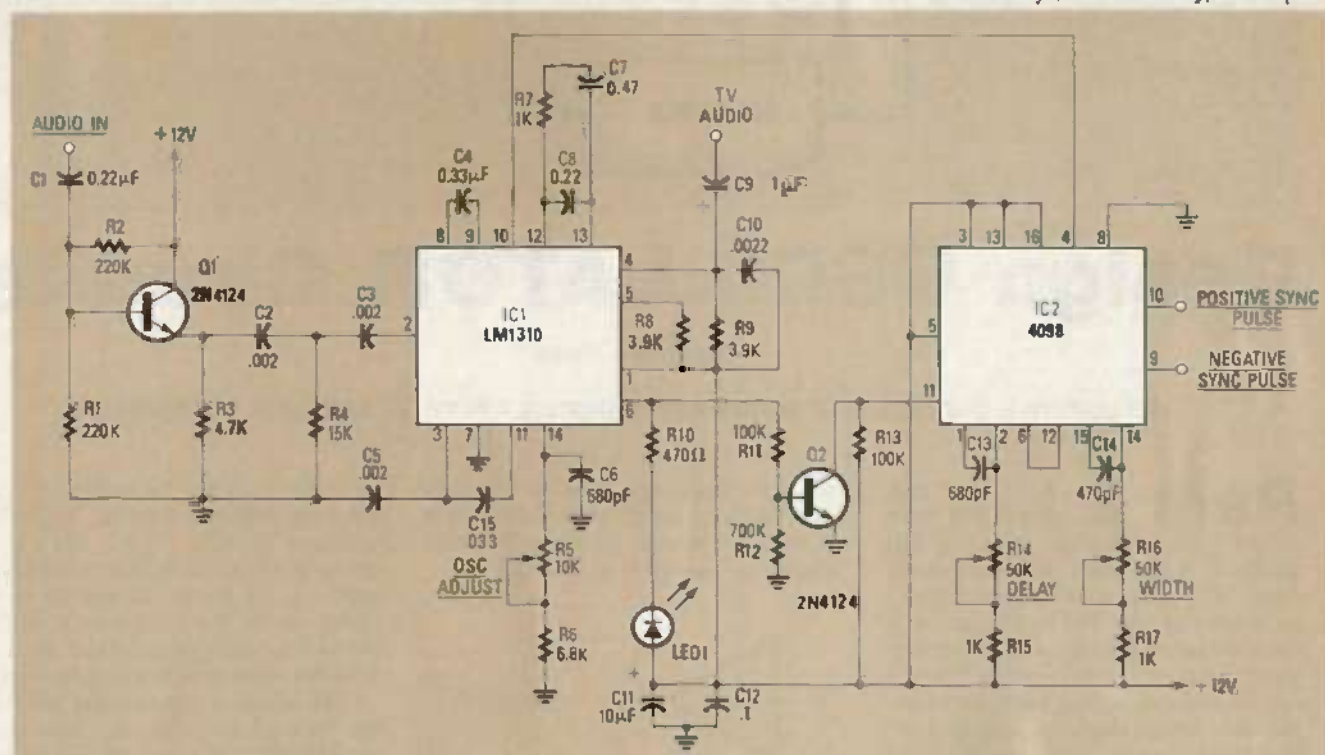

FIG. 8—FOR SYSTEMS WHERE a 15.75-kHz decoding signal is hidden in the audio channel, this circuit can be used to reconstruct a missing sync signal. Note that while IC1 was designed for FM stereo applications, when configured as shown it can be made to operate at 15.75 kHz.

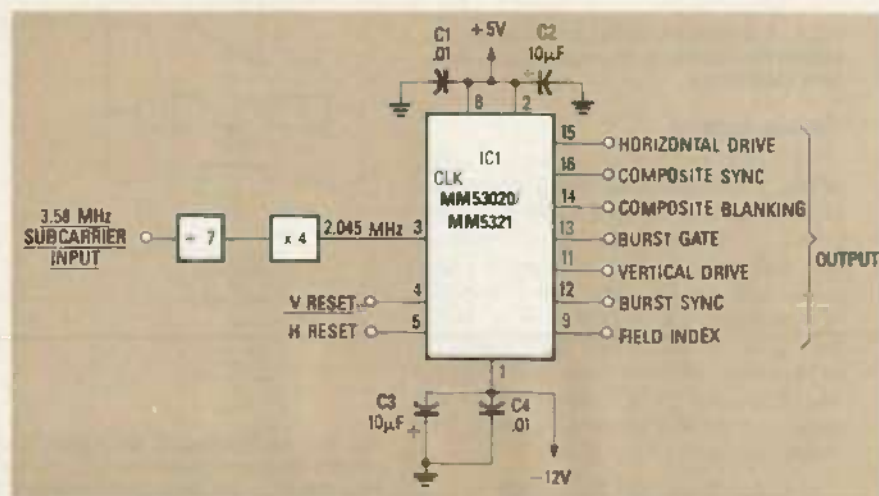

FIG. 9—IF NO DECODING SIGNAL IS AVAILABLE, this circuit can use the 3.58-MHz color-burst signal to reconstruct all of the components of an NTSC sync signal.

plication are shown in Figs. 6 and 7.

In Fig. 6 a standard video RF-amplifier circuit is used as a video IF-amplifier at 44 MHz (that's a standard TV IF frequency). The input signal, which is taken from the tuner or a following IF stage, is made up of a video signal and a superimposed scrambling signal. The gain of the amplifier is altered by changing the bias at gate 1 (or gate 2) of Q1. That technique is normally used in AGC circuits, but if the bias is a DC voltage with a superimposed decoding signal, we can vary the gain in such a way that the encoding signal is canceled. For proper operation, the DC voltage and the decoding signal level must be carefully chosen. Ideally, the output of

the circuit should be an amplified version of the video signal, with all traces of the encoding signal removed.

The circuit in Fig. 7 is built around an LM733 video amplifier. That two-stage, differential-input, wideband video-amplifier is designed for use in a wide variety of video applications. It has a bandwidth of over 120 MHz and selectable gain.

A differential amplifier has the property of producing an output signal that is the product of the gain of the amplifier and the difference between the two input signals. By grounding one input of the LM733, the amplifier can act as a conventional amplifier. The output can be either balanced or single-ended with respect to ground, and the device can be set up to provide two identical output signals that are 180° out of phase, as has been done in the circuit of Fig. 7.

Let's see how the circuit of Fig. 7
continued on page 86

How to

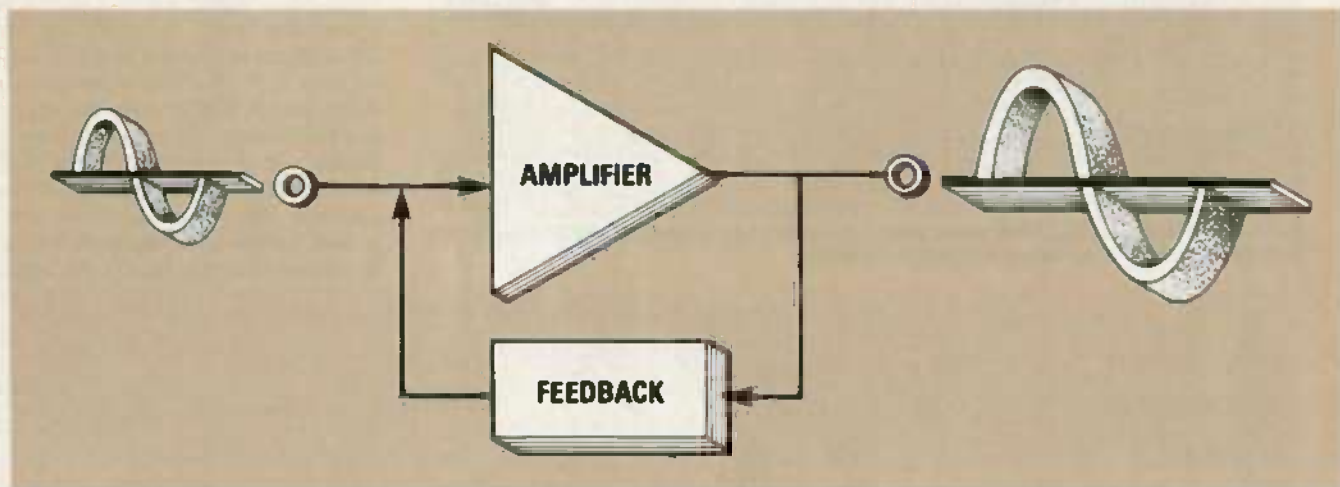

Design OSCILLATOR Circuits

JOSEPH J. CARR

We continue our oscillator series with a discussion of LC feedback oscillators.

Part 2 LAST TIME WE learned that there are two types of oscillator: relaxation and feedback. A relaxation oscillator is built from a neon lamp, a UJT, a tunnel diode, or another device. The non-linear resistance characteristics of those devices are what cause oscillation to occur. Below a certain potential, a neon lamp, for example, does not conduct; but, after that potential is exceeded, the device breaks down and provides a discharge path for a timing capacitor. When that capacitor discharges below the lamp's holding voltage, it stops conducting, and voltage starts to build up across the lamp again. That build-up continues until the threshold voltage is exceeded once again. Oscillation thus continues as long as voltage is present.

A feedback oscillator, on the other hand, is built from a transistor, a tube, an op-amp, or some other active (amplifying) device. Oscillation is brought about by applying a portion of the amplifier's output signal to its input. That feedback signal must be applied in phase with the original input signal. The reason is that, because the amplifier is usually an inverter that provides 180° of phase shift by itself, an additional 180° of phase shift must be provided through some other means.

There are many different ways of providing that phase shift; we'll show sev-

eral of the more popular below. But first, we'll finish up our theoretical discussion of oscillator circuit gain, and then talk about how oscillation gets started.

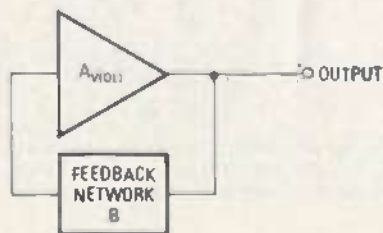

FIG. 1—A FEEDBACK OSCILLATOR may be considered theoretically as an amplifier and a feedback network.

Gain equations

The basic feedback oscillator is shown in Fig. 1. The triangular block represents an amplifier that has an open-loop gain of $-A_{V(OL)}$, where the minus sign implies a 180° difference in phase between the circuit's input and its output. The feedback network has a gain factor B ; in most cases, that "gain" is really a loss. If the circuit is to oscillate, we must make the closed-loop gain, A_V , greater than or equal to unity. As we discussed last time, the closed-loop gain of the circuit is:

$$A_V = A_{V(OL)} / [(1 + A_{V(OL)} \times B)]$$

Finding the value of B is easy, given the

right circuit. In Fig. 2-a is shown a typical three-leg feedback network. We call the reactance elements Z_1 , Z_2 , and Z_3 , implying that they can be either capacitive or inductive reactances, depending on our design needs. For convenience we have shown the amplifying element as an op-amp, but other devices could be used.

Take a look at Fig. 2-b and you'll see that the feedback factor, B , can be stated in a form that resembles the equation describing a resistive voltage divider:

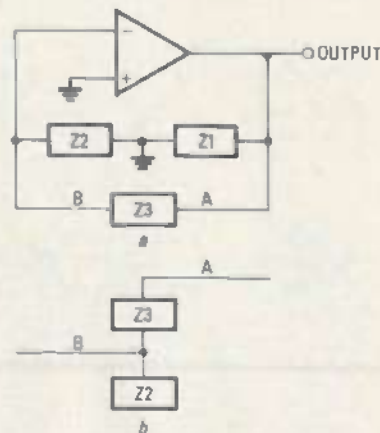

FIG. 2—THE FEEDBACK NETWORK is often composed of three impedances, Z_1 , Z_2 , and Z_3 , as shown at a. For purposes of mathematical analysis, Z_2 and Z_3 may be treated similarly to a resistive voltage divider (b).

$$B = Z_2 / (Z_2 + Z_3)$$

Commonly Z_1 and Z_2 are the same type of reactance, and Z_3 is of the "opposite" type. For example, if Z_1 and Z_2 were capacitors, then Z_3 would be an inductor; if Z_1 and Z_2 were inductors, then Z_3 would be a capacitor.

Whichever feedback technique we use, however, there is still one unanswered question: How does oscillation begin? If oscillation depends on feeding the output signal back to the input in phase, then how can the process begin when there is no output signal to feed back? To use a mechanical analogy, consider a tuning fork. It needs a mechanical stimulus—a sharp rap—to start oscillating. Is there an electrical equivalent to that rap that will get an oscillator running?

The answer, of course, is yes. First, no circuit is ever perfectly noise free. In fact, transistors, tubes, and other active devices have an abundance of noise that initially "rings" the circuit. Second, there is also a variable output voltage that is caused by the varying collector (or drain) current as the device "comes alive." In many cases that change in current is sufficient to ring the circuit into oscillation. However, if the circuit were very quiet or very slow to turn on, it is possible that the circuit would be unable to start oscillating. But, assuming it does start, we usually want oscillation to occur at a specific frequency.

There are many methods of controlling frequency; we'll look now at several ways of controlling frequency using coils and capacitors.

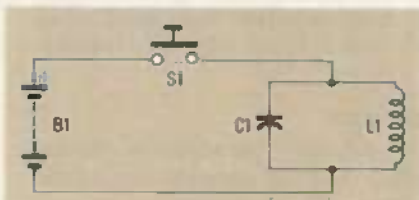

FIG. 3—AN LC TANK CIRCUIT determines the frequency at which many circuits oscillate.

LC oscillators

Let's digress a moment and talk about how a basic LC circuit works. In the circuit shown in Fig. 3, after S_1 has been closed for a period of time, current will flow through L_1 , and that will store energy in the inductor. But when S_1 is opened, the magnetic field of the inductor collapses. That collapse induces current into the circuit, and that current charges C_1 .

After C_1 charges fully the process reverses. The capacitor begins to discharge and that builds up the magnetic field in the inductor. But this time, circuit losses have

reduced the amount of available energy, so the field is weaker than before. The field collapses, C_1 charges, and so on, until all the energy of the circuit has been spent. That steadily-reducing, or damped, oscillation would appear on an oscilloscope as shown in Fig. 4.

Each time the LC tank circuit is "pulsed" by closing S_1 , the oscillations will begin and have a frequency f that is given by the standard resonance equation:

$$f = \frac{1}{2\pi \sqrt{LC}}$$

All LC oscillators function according to the damped-oscillation model discussed above; the frequency at which any given LC circuit oscillates can be described by the equation just given. So, keeping those basic ideas in mind, let's take a look at several popular LC oscillators.

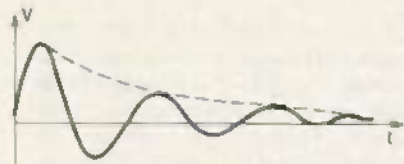

FIG. 4—WHEN PULSED, AN LC tank circuit produces a damped ringing signal as shown here.

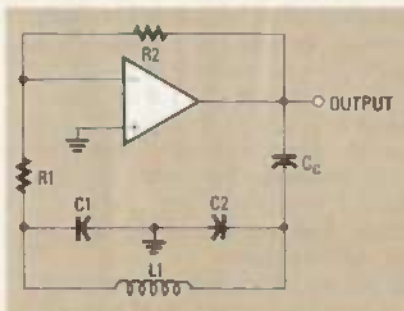

FIG. 5—THE COLPITTS OSCILLATOR is composed of a two-capacitor, one-inductor feedback network.

The Colpitts oscillator

The basic Colpitts oscillator is shown in Fig. 5. Referring to our model circuit in Fig. 2-a, reactances Z_1 and Z_2 correspond to capacitors C_1 and C_2 , respectively, and reactance Z_3 corresponds to inductor L_1 . The circuit's frequency of oscillation is given by the standard resonance formula given above. Values are specified in henrys for coils, and farads for capacitors. Also, the term C in the equation must be calculated from the series combination of C_1 and C_2 in the standard manner:

$$C = (C_1 \times C_2) / (C_1 + C_2)$$

The nominal gain of the Colpitts oscillator is expressed as the ratio R_2/R_1 , and minimum gain is expressed as the ratio C_1/C_2 . We must make the value of

C_2 greater than the value of C_1 if that gain is to be less than unity. In practice, the C_1/C_2 ratio is a trade-off between amplitude and stability.

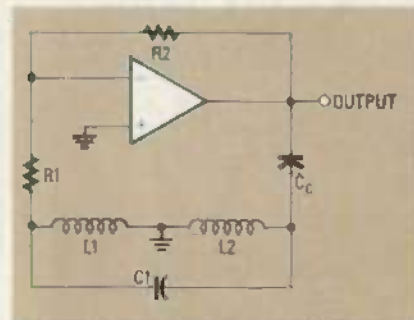

FIG. 6—THE HARTLEY OSCILLATOR is composed of a two-inductor, one-capacitor feedback network.

The Hartley oscillator

The classic Hartley oscillator is shown in Fig. 6. The principal difference between the Hartley and the Colpitts oscillators is the type of reactance elements used for Z_1 , Z_2 , and Z_3 . In the Colpitts oscillator, Z_1 and Z_2 are capacitive, but in the Hartley version they're inductive. A Hartley oscillator may use a tapped inductor, but it's still a Hartley oscillator. Further Z_3 is inductive in the Colpitts, but capacitive in the Hartley. The circuit in Fig. 6 will oscillate at a frequency given by:

$$f = \frac{1}{2\pi \sqrt{(L_1 + L_2)C_1}}$$

Like the Colpitts oscillator, nominal gain of the Hartley oscillator is R_2/R_1 , and minimum gain is L_2/L_1 .

Practical circuits

A discrete-transistor implementation of the Colpitts oscillator is shown in Fig. 7-a. The split-capacitor voltage divider that provides feedback consists of C_2 and C_3 . In general, C_3 has a larger value than C_2 ; typical values are 82 pF for C_2 and 0.001 μ F for C_3 . Resistor R_3 biases the transistor, and R_1 provides stability. The output signal is developed across R_1 . The frequency of oscillation is determined by resonant tank circuit Z , which is connected to the base of the transistor via C_4 as shown.

The tank circuit is composed of a coil and a capacitor, which may be connected in series, as shown in Fig. 7-b, or in parallel, as shown in Fig. 7-c. The series circuit is called a Clapp oscillator because it resembles the series-tuned Clapp oscillator that was popular in the 1950's.

A Hartley oscillator may be built as shown in Fig. 8. Again, a bipolar transistor is the gain-producing element. Resistors R_1 and R_2 bias Q_1 , and play no

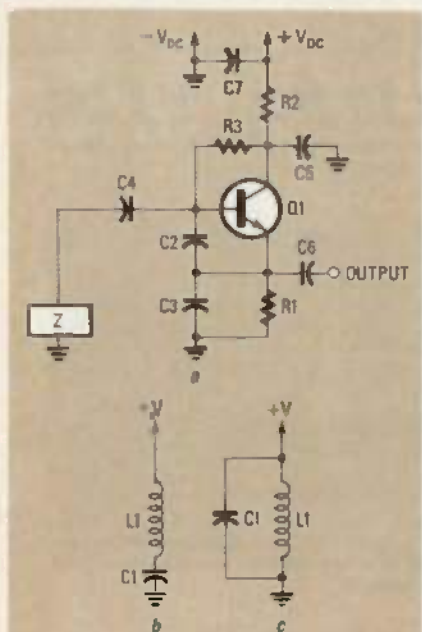

FIG. 7—A COLPITTS OSCILLATOR can be built using a transformer (a). The block marked Z should be replaced by the network shown in b (for a Clapp oscillator) or c (for a pure Colpitts oscillator).

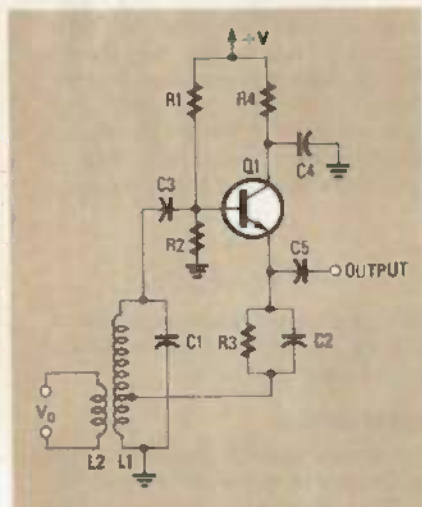

FIG. 8—A HARTLEY OSCILLATOR can also be built using a transistor; oscillating frequency is set by L1 and C1.

other role. Oscillating frequency is determined by the resonant tank circuit that is made up of L1 and C1, and the output signal can be taken either from the emitter of the transistor via C5, or from coil L2, which is coupled to L1. The position of L1's tap is a trade-off between the stability and the amplitude of the output signal.

As a final word before we move on, both Hartley and Colpitts oscillators are common-collector circuits, because the collector of the transistor is at AC ground by virtue of the presence of a bypass capacitor—that capacitor is C5 in Fig. 7-a, and C4 in Fig. 8.

The Armstrong oscillator

There are many additional types of LC

oscillators, but two are particularly interesting, historically speaking. The Armstrong oscillator is named after Major Edwin Armstrong, who invented the regenerative detector, the superheterodyne radio, frequency modulation, and other

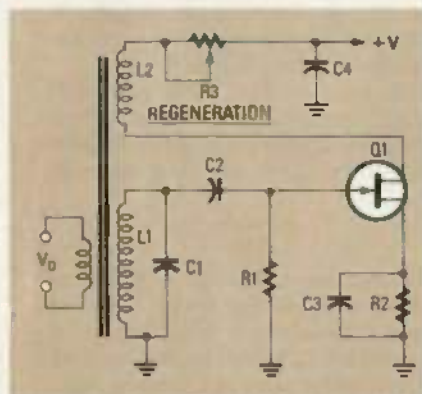

FIG. 9—THE ARMSTRONG OSCILLATOR is the basis of many circuits including the regenerative radio receiver.

things. A modern version of the Armstrong oscillator is shown in Fig. 9. That circuit uses a FET as the amplifying element; the original Armstrong circuit used a tube. Another popular name for the Armstrong oscillator is the "tickler oscillator;" we'll see why in a moment.

The Armstrong circuit's frequency of oscillation is determined by the values of the components in the parallel-resonant tank circuit composed of C1 and L1. A feedback coil, or "tickler" coil, L2, is closely coupled with L1, and the tickler serves to feed part of the output signal back to the input. Care must be taken to be sure that the mutual inductance between L2 and L1 is of the proper "polarity." Otherwise feedback will occur, and the circuit won't oscillate.

The amount of feedback, or regeneration, is controlled by variable resistor R3; that resistor controls the amount of current flowing in the tickler coil. In older circuits, the tickler coil was wound on a mechanism that permitted the position of

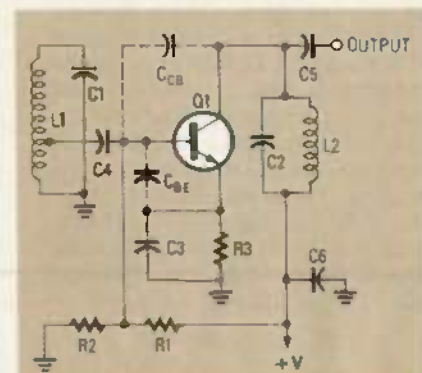

FIG. 10—THE TITO OSCILLATOR uses an LC tank at both the input and output of the circuit; the two tanks are tuned near, but not precisely at, the same frequency.

the coil to be varied with respect to L1. When coupling was maximum, so was feedback. The frequency of oscillation of the Armstrong oscillator may be calculated by plugging the values of L1 and C1 into the resonance equations that we cited earlier in this article.

The TITO oscillator

Our final LC oscillator has been called by several different names in the past. In older texts that illustrate the use of vacuum-tube circuits, the circuit is called a Tuned-Grid-Tuned-Plate (TGTP) oscillator. More recently it has been called a Tuned-Base-Tuned-Collector (TBTC) oscillator. Perhaps now that we have so many types of amplifying devices, the circuit should be called a Tuned-Input-Tuned-Output (TITO) oscillator.

Whatever we call it, it looks something like the circuit shown in Fig. 10; the frequency of oscillation of the circuit is set by both the L1/C1 and the L2/C2 tank circuits. Most textbooks recommend that the two tank circuits resonate at almost equal, but slightly different, frequencies.

Feedback in the TITO oscillator is brought about through inter-element capacitance in the transistor. In other words, C_{BE} (the capacitance between base and emitter) and C_{CB} (the capacitance between collector and base) are not external capacitors; they are part of the structure of the transistor. That is why they have been shown in dashed lined in the illustration.

The TITO oscillator is rarely used these days, even though the local oscillators in some TV and FM receivers are, implicitly, the TITO type. That sort of circuit may appear to have no capacitors and only inductors but don't be fooled. The designers of the circuit intended for stray device and circuit capacitance to be sufficient to produce oscillation at the desired frequency.

Conclusion

We've covered quite a bit of ground this month, so let's take a moment to step back and recap what we've done.

After deriving the gain equation of a generalized oscillator circuit, we discussed how oscillation may be initiated by start-up currents in the circuit, or even by random circuit noise. Then we reviewed the operation of LC tank circuits. With that theoretical background, we then went on to look at Colpitts and Hartley oscillators. After examining them theoretically, we discussed several practical circuit implementation. Finally we discussed several historically interesting circuits: the Armstrong oscillator and the Tuned-Input-Tuned-Output (TITO) oscillator.

When we continue next time, we'll discuss RC oscillators that are built from op-amps. R-E

BUILD THIS

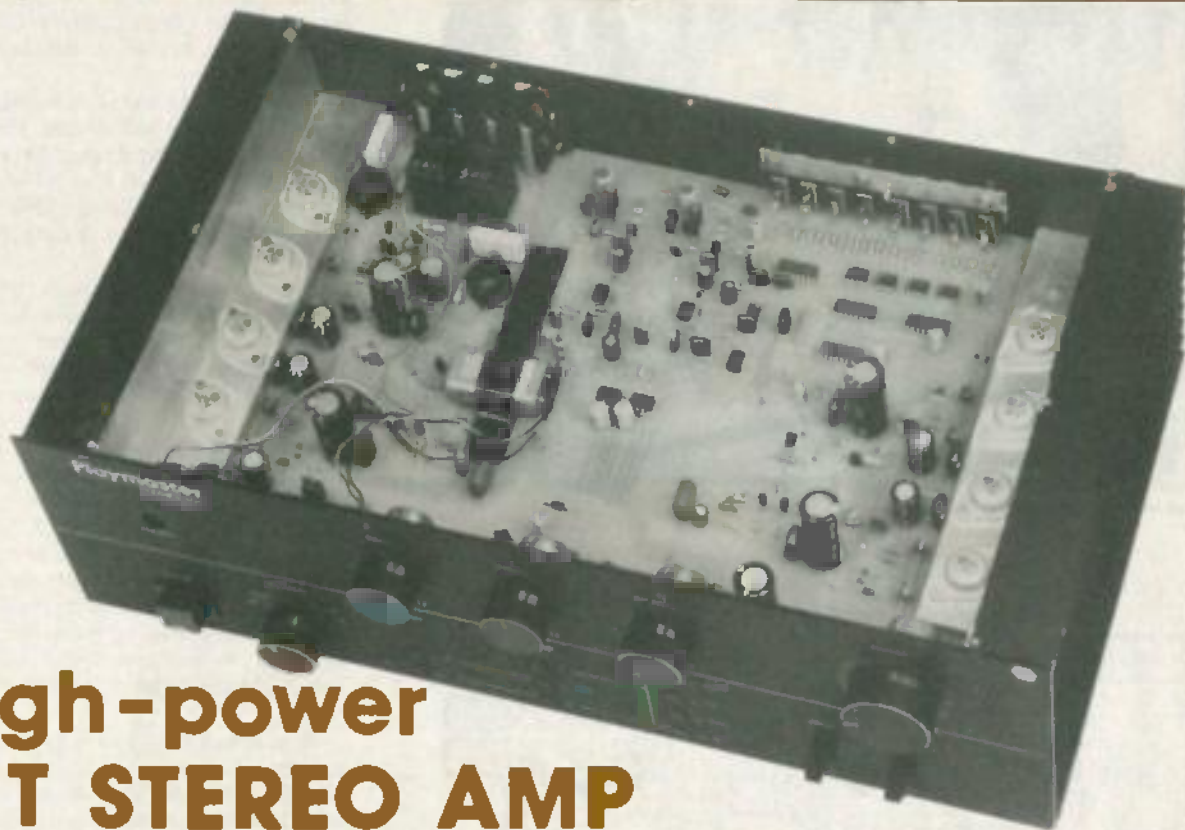

High-power FET STEREO AMP

After several months of theoretical discussion, it's time to get our hands dirty and build this audiophile's dream amplifier!

LEO SIMPSON AND JOHN CLARKE

Part 3 WE'VE SPENT SEVERAL months talking about how the amplifier works and the philosophy behind its design. We've all had enough theory—so let's start building an amplifier!

Mechanical overview

First of all let's talk about PC boards. Two are required: the control board, which contains most of the digital input-switching circuitry, and the main board, which contains the vast majority of all other components. If you want to etch your own, we show the foil patterns for both boards in this issue's PC Service; alternatively, you may purchase boards from the source mentioned in last month's Parts List. In any event, we don't recommend that you try to build the amplifier without PC boards; success using any other construction technique is highly doubtful.

As you can see in Fig. 10, the mechanical arrangement of our amplifier is rather unusual in that two large heatsinks serve

both as endpanels and as supports for the main PC board. That arrangement allows the output transistors to be bolted to the heatsinks and their leads soldered directly to the appropriate pads of the PC board. In addition, the front and rear panels bolt directly to the heatsinks, and so do the top and bottom panels. Both the top and the bottom panel also have flanges that help secure the front and rear panels making for a mechanically stable cabinet.

The terminals of the tape input/output jacks, the main input jacks, and the speaker connectors are soldered directly to the rear of the PC board; the jacks themselves protrude through cutouts in the rear panel, to which they are bolted. Similarly, on the front panel, the shafts of the PC-board mounted BASS, TREBLE, BALANCE, and VOLUME control potentiometers protrude through holes in the front panel, to which the potentiometers are secured using nuts.

Unlike the other switches and the potentiometers, the POWER, SPEAKER SELECT, MONO/STEREO, and MUTE switches are not soldered directly to the PC board. They are connected to it using short

lengths of hookup wire and they are secured to the front panel with the appropriate mounting hardware.

The control board attaches to the front panel by means of three short threaded bushings. The bushings are attached to the component side of the PC board; the board is then screwed to the front panel. The lower screws pass through flanges on the base plate.

As shown in Fig. 9 last time, the high-voltage power supply components (T1, BR1, C8-C11) are mounted on the base plate of the amplifier, below the main PC board. Several screw-terminal strips are also attached to the base plate to facilitate interconnections between C7, S1, the line cord, and T1.

Electronic assembly

Construction is straightforward and mostly involves installing parts on the two PC boards. Before mounting any components, inspect both boards for shorted or open traces. Repair any faults before proceeding. A few minutes spent correcting faults on the PC board now could save considerable frustration—and cash—

*Adapted from material published by *Electronics Australia*



FIG. 10—MOST SWITCHES AND POTENTIOMETERS are soldered directly to the PC board; that eliminates much tedious wiring by hand.

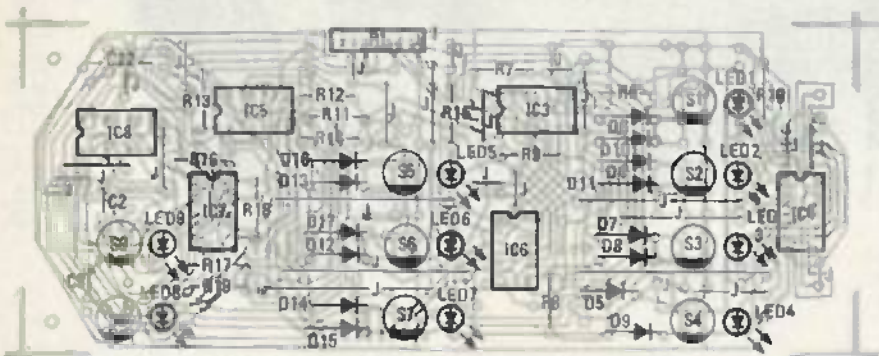

FIG. 11—MOUNT THE CONTROL-BOARD COMPONENTS as shown here. The switches and LED's mount with their flat sides down, and P1, if used, mounts to the back side of the board.

later on.

First let's build the control board. Follow the component overlay shown in Fig. 11 when installing the parts. Start with the jumpers and the diodes, then insert the resistors and the capacitors, the IC's, and the switches (S1-S9). Make sure that all semiconductors and the electrolytic capacitor (C22) are oriented correctly. The proper orientations are shown in Fig. 11. The two 0.047- μ F capacitors (C2 and C3) must be pressed flat against the board; otherwise it will not mate with the front panel correctly. The switches should be oriented so that the flat side of each switch faces the edge of the PC board that mounts closest to the main board.

Last, install the LED's. The tops of the LED's should be the same height above the board as the tops of the switches. Before moving on, make sure that the LED's are oriented correctly—the flat side of each LED goes toward the bottom of the board.

After all parts are mounted, check everything carefully. After you're sure everything has been installed correctly, remove flux from the back of the board and solder a nine-pin SIP header plug in the space allotted for P1—but on the solder side of the board. Since the PC board

is not double-sided, it has no pads on the component side, so you'll have to leave a enough space between the body of the connector and the PC board for the tip of your soldering iron to fit in. To solder the connector in place, tin pin 1 of P1 and the pad to which it will be soldered. Then melt the solder on the pad, insert the plug, and adjust it so that the body of the plug is parallel to the board. Remove your soldering iron. If the plug moves, re-heat the joint, and re-adjust the position of P1. When it is in place properly, solder pin 9 to the board. Then solder the remaining pins.

Wire up a nine-conductor cable with nine-conductor SIP sockets on both ends. Rather than use plugs and sockets, you could just hard-wire a nine-conductor cable from the control board to the main board. In either case, make sure the cable is long enough to reach both boards when they are installed in the chassis! Your completed board should appear as in Fig. 12. As you can see, for our prototype we hard-wired the cable and didn't use a plug-and-socket; use whichever arrangement suits you best.

The main board

Obviously it will take considerably

longer to build the main board than it took to build the control board. The chances for error are also considerably greater. So take your time, be careful, and check your work often!

Refer to Fig. 13 and start installing the jumpers, resistors and diodes. Take particular care with the diodes. Don't confuse the 5.6- and 9-volt Zener diodes, and make sure that you install the IN4002 and the IN914 diodes in their designated positions.

The IC's and the transistors can be installed now, but don't mount the power transistors yet. Many different types of transistor are used in this circuit, so make sure that the correct one is inserted at each location. When mounting the IC's, make sure that they are oriented correctly and solder the power-supply pins first. Power is applied to pins 4 and 7 of the op-amps (TL071, NE5534), and to pins 7, 8, and 16 of the CMOS analog switches (4052, 4053). Then go on and solder the signal-carrying pins. After soldering, check for solder bridges between every pin and its neighbor. A little time spent doing that now could save a lot of time and money later.

Now install the capacitors. Since we use several capacitors with the same capacitance but different voltage ratings, take a few extra moments and be sure that you install the correct unit at each location. And be sure that the polarized capacitors are oriented correctly; the proper orientations are shown in Fig. 13.

The fuse clips, relays, trimmer potentiometers, and all the other small board-mounted components except the power transistors can be installed next. For best results, observe the recommendations that follow.

Now cut the shafts of the potentiometers to a length of about 1/2 inch. Then solder the potentiometers to the board. The lugs of the potentiometers should be inserted into the PC board all the way so that the shafts will line up with the holes in the front panel.

The strip of RCA jacks (J100-J107, J200-J207) supplied with the kit includes a ground lug that must be removed. Then cut the strip to an overall length of about 4 3/4 inches with a hacksaw. Last, drill a hole directly above the last RCA jack at the same height as the other mounting holes in the strip. Once all of that has been done, mount the strip on the PC board and solder the lugs.

The loudspeaker terminals can be installed now. Make sure that the two plastic locating lugs that are on those loudspeaker terminals mate with the appropriate holes in the PC board.

We used PC stakes to terminate wiring from the switches, the jumpers, and the power supply. Since most of those connections terminate on the underside of the

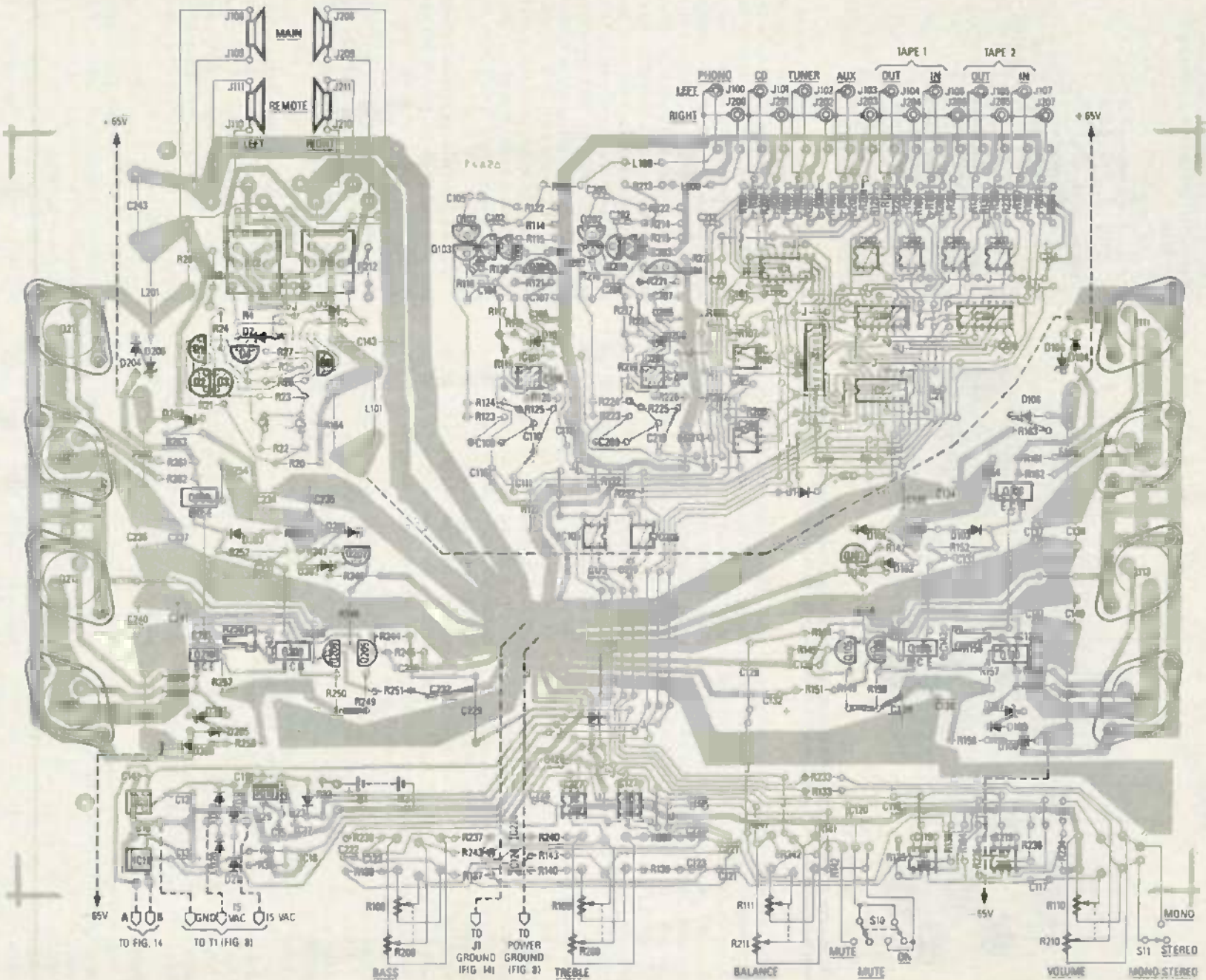

FIG. 13—MOUNT THE MAIN-BOARD COMPONENTS as shown here. A heavy jumper wire must connect the pad near Q113 to the pad to which R164 and L101 are soldered. Also, several additional wires (shown at the front left side of the board) are routed beneath the board.

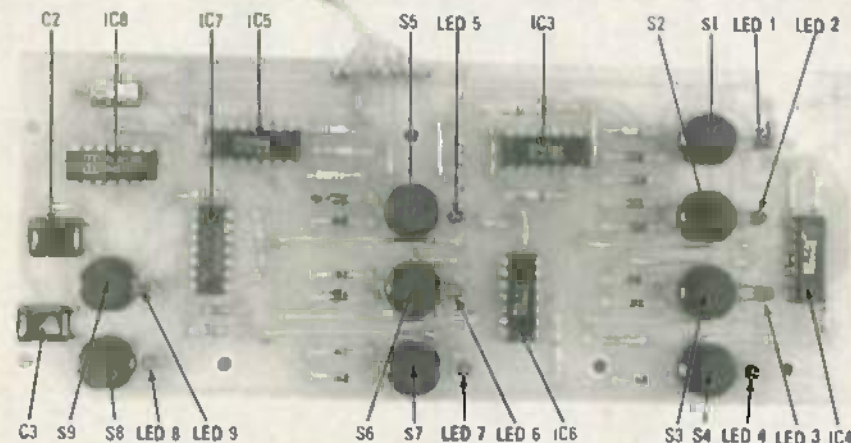

FIG. 12—THE COMPLETE CONTROL BOARD appears as shown here. Capacitors C2 and C3 must be bent flat against the board so that it won't interfere with the front panel.

board, the stakes should be mounted on the underside. The exceptions are the stakes that the Ni-Cd batteries (B1 and B2), the headphone jack (J1), and the 7815 regulator (IC9) are connected to—those components are wired to the top of the board, so the stakes should be inserted from the top of the board and then soldered from the bottom.

Winding the coils

A small hand-wound coil is wired in series with the input of each phono pre-amplifier. Wind each coil by feeding 5.5 turns of 28-gauge enameled copper wire through the center of the small ferrite bead. When complete, about 1/2 inch of wire should exit from each end of the bead. Remove about 1/4 inch of insulation from each end of the wire and then solder the coil in place.

A larger 6.8 μ H choke is connected in series with the output of each power amplifier. Wind each coil with 24.5 turns of 18-gauge enameled copper wire around a 7/16-inch plastic coil form. You'll have to wind three layers; the ends of the wire should exit from either side of the form 180° apart. Remove about 1/4 inch of insulation from both ends, bend the leads down 90°, and solder the coil in place.

Power transistors

The MOSFET power transistors must be isolated from the heatsink using mica washers, silicone grease, and insulating bushings. Note that the heatsink which supports the right side of the PC board must be notched slightly in order to provide clearance for the VOLUME control. The power transistors are secured to the heatsinks with no. 6 screws and nuts. After each transistor is mounted, use your multimeter to make sure that there is no continuity between its case and the heat-

sink. When you're sure there's no continuity, solder the leads of the transistors to the PC board. You should also solder the mounting nuts to the PC board to ensure reliable long-term contact between the case of each transistor and the copper traces.

Finish building the main PC board now by installing the three voltage regulators and the headphone jack. The 7915 and 7805 regulators are soldered directly to the PC board. The 7815 is bolted to the left-hand heatsink and it must be electrically insulated from it using a mica washer, silicone grease, and an insulating bushing. Once again, use your multimeter to make sure that the metal tab of the regulator is isolated from the heatsink. The regulator leads are soldered to three PC stakes.

The headphone jack is mounted on a small L-shaped bracket that is bolted to the left-hand heatsink above the 7815. The barrel of the headphone jack must not make contact with either the heatsink or the front panel.

Now wire the MONO/STEREO (S9) and the MUTE (S11) switches to the appropriate pads on the PC board as shown in Fig. 13. Connect the beneath-board jumper from the output of the right-channel power amplifier to the appropriate pad near the relays. That wire should be at least 16 gauge.

Connect the other two beneath-board jumpers now. Those jumpers connect two pads at the front left of the board (shown in Fig. 13) to two pads in the row of five pads in front of the relays (shown in Fig. 14). Then connect wires to headphone jack (J1) and SPEAKERS switch S12.

Power supply assembly

Work can now proceed on the power supply components. Follow the wiring di-

Inadvertently the resistors in the figure shown here were not shown in Fig. 1 (in the June 1986 issue). In addition, the Parts List in that issue contained several errors. The correct Parts List was published in the July issue.

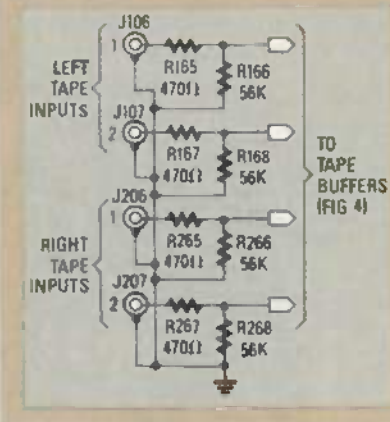

agram in Fig. 8 (shown in the July issue) carefully since any errors here could be disastrous. Use insulating sleeves on the 0.01 μ F capacitor (C7), and insulate the pins on the power switch with several turns of plastic tape or heatshrink tubing.

Bolt the transformer to the case with a bolt, a metal disc, and two large rubber washers. One washer is sandwiched between the transformer and the base, and another between the transformer and the disc. The four 8000 μ F filter capacitors (C8–C11) are secured using aluminum brackets. The bridge rectifier is smeared on both surfaces with heatsink compound; then it is bolted to the base plate. Complete the power-supply wiring with 16-gauge wire.

Secure a 3-screw terminal block to the base plate and attach the 117-volt hot and neutral leads to it. The ground lead is soldered to a solder lug bolted to the base plate. Make the ground wire longer than the others so that this lead will be the last to break if the power-cord is pulled out.

Final assembly

With the base panel wiring completed, connect the 9-conductor ribbon cable from P1 on the control board to P2 on the foil side of the main PC board. Then make the connections between the high-voltage power supply, the 15–0–15 tap on T1, and the main PC board.

Use heavy duty cable—16 gauge or greater—for the \pm 65-volt power-supply connections. Run separate leads from the terminals of the 8000- μ F capacitors to each power amplifier.

The chassis can now be assembled. The first step is to secure the base panel to the heatsinks using six machine screws. Four adhesive rubber feet can then be fitted in the corners.

Secure the power cord in place using a grommet, then fasten the rear panel to the heatsinks and to the base panel.

Next secure all loose switches to the front panel, and then attach it to the main assembly.

Then mount the front panel and make sure that the switches, the LED's, the potentiometers, and the headphone socket line up with the panel holes correctly. It may be necessary to shift the control board to one side or the other slightly to ensure that the switches align with the holes in the front panel. The front panel is secured to the heatsinks using counter-sunk, painted, self-tapping sheet-metal screws. Finally, nuts can be threaded onto the shafts of the potentiometers, and the knobs can be press-fitted.

Testing

STOP! Before going further, carefully check your work against the wiring and parts-placement diagrams.

Assuming everything checks out, remove the four five-amp fuses and apply power, but do not connect any signal sources or loudspeakers yet. One or more LED's on the front panel should light up immediately after power is applied.

Using your multimeter, check the outputs of the power supply. You should be able to measure ± 65 volts at the fuse clips. Pins 7 and 4 of each op-amp should have +15 and -15 volts, respectively, and pins sixteen and seven of the CMOS switches should have +7.4 and -7.5 volts, respectively. The +8-volt supply can be checked by measuring the voltage at the output of the 7805 (IC10). That voltage can be reduced if necessary by reducing R29 from 130 to 120 ohms. If any supply voltage differs by more than 10% from its nominal value, remove power immediately and locate the fault.

When all power-supply voltages are correct, measure the voltages at several critical points in the circuit. There should be about 4.8 volts across R120, the 2.7K current-limiting resistor connected to the drain of Q104, which is the FET constant-

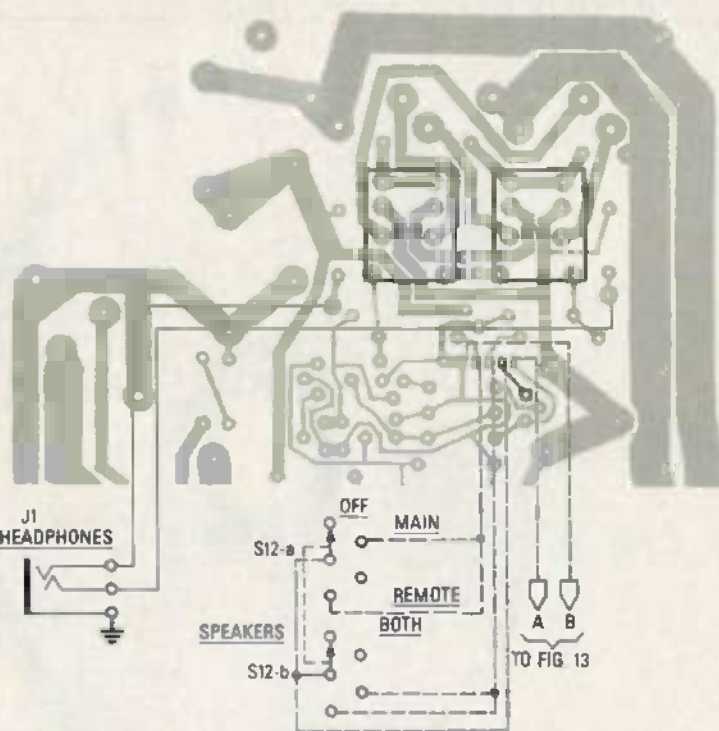

FIG. 14—THE LEFT REAR CORNER OF THE MAIN BOARD is shown here. The headphone jack (J1), the speaker switch (S12), and two jumpers are wired to the row of pads in front of the relays. The wires to J1 are routed above the PC board; the remainder are routed below the board.

current source in the phono preamplifier. Also, there should be about 4.9 volts across the collector of each transistor (Q100-Q103) in the input stage of the phono preamplifier. Those voltages should also be present in the corresponding right-channel components (R220 and R200-Q203).

In the power amplifier stages, there should be 0.6 volt across R147, the 680 Ω emitter resistor of Q107. You should also measure about -55.5 volts at the collectors of Q105 and Q106. In addition, you should measure about 0.6 volts across R154, the 100 Ω emitter resistor of Q108. Those voltages should also be present in the corresponding right-channel components (R247, Q205, Q206, and R254). If any of the voltages you measure differ by more than 10% from the values given, track down the source of the problem before continuing.

Setting quiescent current

When all voltages are correct, remove power and monitor the +65-volt supply at F100. After the supply falls below +5 volts, install a fuse there. Then connect a 1-amp ammeter F101's fuse clips. Rotate R156 fully counter-clockwise, and then apply power. Adjust R156 so that the meter indicates a current of 100 mA.

Remove power, and then wait two minutes for the voltage to drop. Remove the meter and install a fuse there. Repeat the procedure for the right-channel.

Now check the operation of the control switches. The LED associated with each

switch should illuminate as that switch is pressed; no other LED in that section of the front panel should be lit. Also test the MONITOR and DUBBING switches and LED's.

Next, the Ni-Cd battery pack can be connected. Use a small rectangle of double-sided adhesive tape to secure the battery pack to the PC board. With the batteries in place, make sure that the switch settings are stored when power is removed. Note that the stored settings will change if the switches are pressed while power is off.

If the switches do not operate correctly, check the power supply connections to the IC's on the control board. If the correct voltages appear, then the problem possibly lies with the digital control lines from the control board to the main board.

Finally, connect a pair of loudspeakers, apply power, and listen for hum or other unpleasant sounds. If everything is working correctly, you should hear only a very slight amount of hum when the PHONO input is selected and the VOLUME control is fully advanced. Connect a turntable and verify that the VOLUME, BASS, TREBLE, and TONE controls work correctly. Similarly, verify that the SPEAKER, STEREO/MONO, and MUTE switches all work correctly. Make sure signals from each of the four main inputs (PHONO, CD, TUNER, and AUX) can be heard through the speakers. Last, connect a pair of tape recorders to the appropriate jacks and verify that the MONITOR and DUBBING switches work correctly.

R-E

ORDERING INFORMATION

Note: The following components are available from Dick Smith Electronics, Inc., P.O. Box 8021, Redwood City, CA 94063; 800-332-5373 (orders) 415-368-8844 (Inquiries). Complete kit of all parts (No. K-3516) including PC boards, heatsinks, screened front and rear panels, and transformer T1, \$299 plus \$10 shipping. Separate components: set of two PC boards (No. KH-0106), \$49.00; 2SC2545 transistor (No. KZ-1683), \$0.39 each; 2SK134 transistor (No. Z-1815), \$4.50; 2SJ49 transistor (No. Z-1816), \$4.50; transformer T1 (No. KM-2000), \$57.00; case including panels and heatsinks (No. KH-2700), \$115. All component orders must add \$1.50 for handling plus 5% of total price. California residents must add 6.5% sales tax. Orders outside U.S. must include U.S. funds and add 15% of total price for shipping.

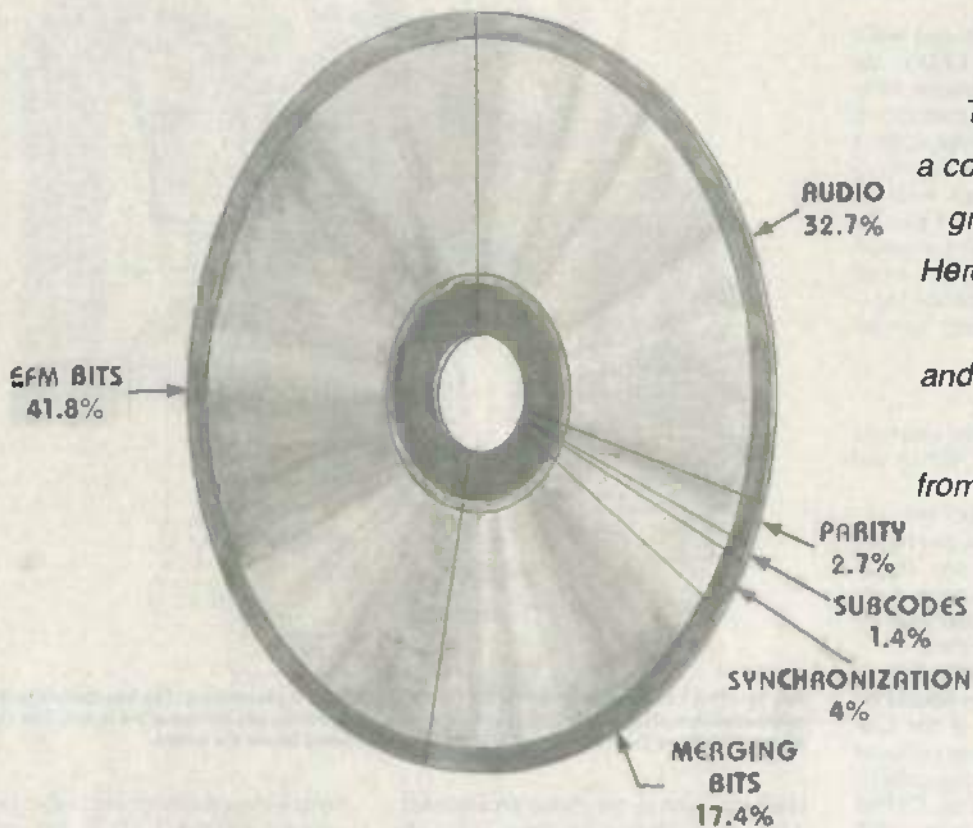

There's a lot more on a compact disc than just great-sounding music. Here, we see what all of that other "stuff" is, and the role that it plays in getting the music from the disc to your ear.

JOSEF BERNARD

COMPACT DISCS Bit-By-Bit

EVERYONE KNOWS THAT CD'S, COMPACT Discs, contain a lot of information—maybe even millions and millions of bits. But as we'll soon see, "millions and millions" is only a drop in the bucket for a CD.

In one second, a CD player processes 1,460,000 bits of audio information. That's just a hair under 6.5 billion bits during a CD's maximum playing time of 74 minutes. But that is still only the tip of the iceberg, because those 6.5 billion bits represent just the audio information contained on a disc. There's twice as many more, most of which you are never aware of. But without those bits, the music would never find its way off a CD.

That extra information is used for modulation, synchronization, and error correction, and for index, track, and sector data that helps a CD player to reproduce audio in the proper sequence and to locate a requested selection. There are 2,861,800 bits of non-audio information processed for every second of music you hear—10,302,500,000 bits for each hour of music. In all, a compact disc can contain a total of just under 20 billion bits—19,918,878,200 to be precise. To say the least, that's impressive!

Now that we've whetted your appetite,

we're sure that you are curious about what purpose all that data serves. Well, read on.

CD Information

Whether it was originally recorded in analog or in digital form, what you hear from a CD goes onto that disc in digital form. The music, or whatever else was recorded, is transferred from its original recording medium to a digital master tape.

In preparing the master tape, all the information that will appear on the finished compact disc is put onto it. That data consists of:

- audio information
- error-correction information
- index, track, and sector information

• synchronization information

All of those are converted into an intricate and carefully woven string of ones and zeroes.

Just as personal computers work with bits in groups of 8 or 16, compact discs use data groups called frames. Each frame (Fig. 1) contains 588 bits; by examining the use of those bits we can discover how data is stored on a compact disc.

Before dissecting a frame, though, let us take some time to discuss the error-correction scheme used in CD's. That is important, because it allows us to understand what happens to the "pure" audio information.

Error correction

Manufacturing compact discs is a deli-



FIG. 1—MOST, BUT BY NO MEANS ALL, of the information in a frame of CD data is dedicated to the audio program.

cate process, requiring extreme cleanliness and very tight tolerances. Because of that, it is nearly impossible to make a "perfect" disc. With just under 20 billion bits involved in a lengthy recording, something is bound to go wrong somewhere, whether it's a piece of dust trapped under the disc's protective transparent plastic coating, or perhaps a scratch in the coating itself.

To cope with the inevitable, the audio information on CD's is encoded using error-correction techniques that allow a CD player to recover from any errors that crop up. Sometimes the player can reconstruct the lost or incorrect audio (which is usually very short in duration); at other times it mutes its output until the error passes.

The muting process, by the way, is interesting—the player can detect an unrecoverable error before it becomes audible, so it slowly (on its time scale) lowers the output level before the error and slowly raises it again after it. That fade-out/fade-in process makes the dropout less noticeable to the listener.

The system used to encode the error-correction information is based on a Cross-Interleave Reed-Solomon Code, or CIRC. According to strict rules, information from any given section of the audio is broken up and placed in several different frames located at different places on the disc. During playback, the information is reconstructed in the proper order. The process used is rather involved, so in the interest of space we will not detail it here. In any event, what's important is that the process ensures that an error will usually not destroy a passage completely, since all the information pertaining to that passage is not clustered in one spot.

Error detection, which is of course necessary before error correction can be performed, is made possible by the generation of two 32-bit sets of parity bits. Those parity bits give an indication of the numeric value of the data they are responsible for. If there is a discrepancy between that value and the value indicated by the parity bits, it is almost certain that an error has occurred and that corrective action has to be taken.

The two sets of parity bits are used for different purposes. One set, called the P bits, is used to detect and correct errors due to dropouts. The other set, the Q bits, allows a player to determine whether a correctable error has occurred, and assists in correcting it.

Using the CIRC, errors as long as 4000 bits can be fully corrected. Errors up to 12,300 bits long can be compensated for by the interpolation of data—a CD player's way of "faking" the missing or erroneous information by reconstructing it from the information that precedes or follows the fault. Out of a single frame's 588 bits, 64—or approximately 10.9%—are used for parity checking.

What's in a frame

With most of the more exotic stuff out of the way, we can now examine a single CD data-frame. Note that a disc contains nearly 34 million of them.

Let's look once again at Fig. 1. That illustration shows the makeup of a frame of data. The biggest part of it (192 bits—about 33%) is audio information, stored as two sets of 12 blocks of 8 bits each. As shown in Fig. 2, blocks are arranged alternately as left channel, right channel, left channel, and so forth. That helps to explain why the channel separation on CD's can be 90 dB or greater—the left- and right-channel information blocks are stored separately.

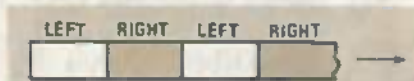

FIG. 2—STEREO AUDIO INFORMATION is recorded in alternating, right-left-channel blocks. That is one reason for the high level (90 dB) of stereo separation.

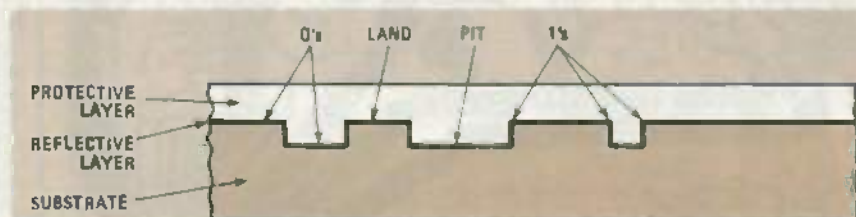

FIG. 3—DIGITAL INFORMATION IS ENCODED on a CD using a system of pits and lands. Every transition between a pit and a land, or a land and a pit, is a logic one; the lands and pits themselves are logic zeros.

The parity bits make up the next largest collection of information; each frame contains 32 P and 32 Q bits. Those 64 bits account for, as was mentioned previously, almost 11% of the disc's capacity.

The third largest part of a frame contains the 24-bit synchronization code. That code is used to indicate the beginning of a frame. When a CD player sees the synchronization code, it knows that a frame will follow immediately, and is able to assign the bits that come next to their proper functions.

The last major bit-group contains the subcodes. There are eight subcodes, P through W, and every frame contains eight subcode bits: one from each group. The P and Q subcodes, which are the ones of interest to us here, have no connection with the P and Q parity bits; the similarity in names is just coincidence.

The subcodes are collected during playback 98 frames at a time. The P bits indicate to the player which portions of the disc are for lead-in and lead-out, and which portions contain playable passages. The Q bits contain information indicating track and index numbers (which are used by programmable CD players to locate the selections you've programmed) and timing data for each selection, and for the disc as a whole. That information can be displayed by some players. The eight sub-

code bits make up only about 1.4% of a frame's total.

Now let's count up the bits in a frame. Here's what we have, based on what we know so far: Audio, 192; Error correction, 64; Synchronization, 24; and Subcodes, 8. Adding those up gives us a total of 288 bits.

But wait a minute! There are supposed to be 588 bits in each frame, and we've only accounted for 288 of them. What about the other 300? Stand back; here they come!

Eight-to-fourteen modulation

Contrary to what you may believe, the pits and lands (the flat areas between the pits) on the surface of a CD do not, themselves, represent ones and zeroes. Rather, as shown in Fig. 3, each transition between a land and a pit, or a pit and a land, represents a one. Any other part of the disc, whether it be its shiny surface or the bottom of a pit, is taken to be a zero. The

length of a pit (or the land between two pits) determines the number of zeroes in the number. The method used on CD's to create the numbers represented by those strings of ones and zeroes is called EFM, for Eight-to-Fourteen Modulation.

The data on a compact disc was originally organized as 8-bit bytes. Why convert those to 14-bit words? The reason is that longer words allow for the greatest number of zero-to-one and one-to-zero transitions that can be obtained while optimizing the lengths of the pits and the lands for the best usage of the disc's "real estate." Despite its longer words, EFM is actually about 25% more efficient than recording done using an 8-bit format.

The missing bits

One of the characteristics of eight-to-fourteen modulation is that each 14-bit (formerly 8-bit) word has 3 more bits, called merging bits, added to it. Those additional bits are necessary for EFM to work properly. Disregarding for the moment the 24-bit synchronization word, we can see that we have a total of 33 8-bit words per frame: 24 audio words, 8 parity words, and 1 subcode word. Those require a total of 99 merging bits. The 24-bit synchronization word also requires 3 merging bits, bringing the total to 102

continued on page 85

PC SERVICE

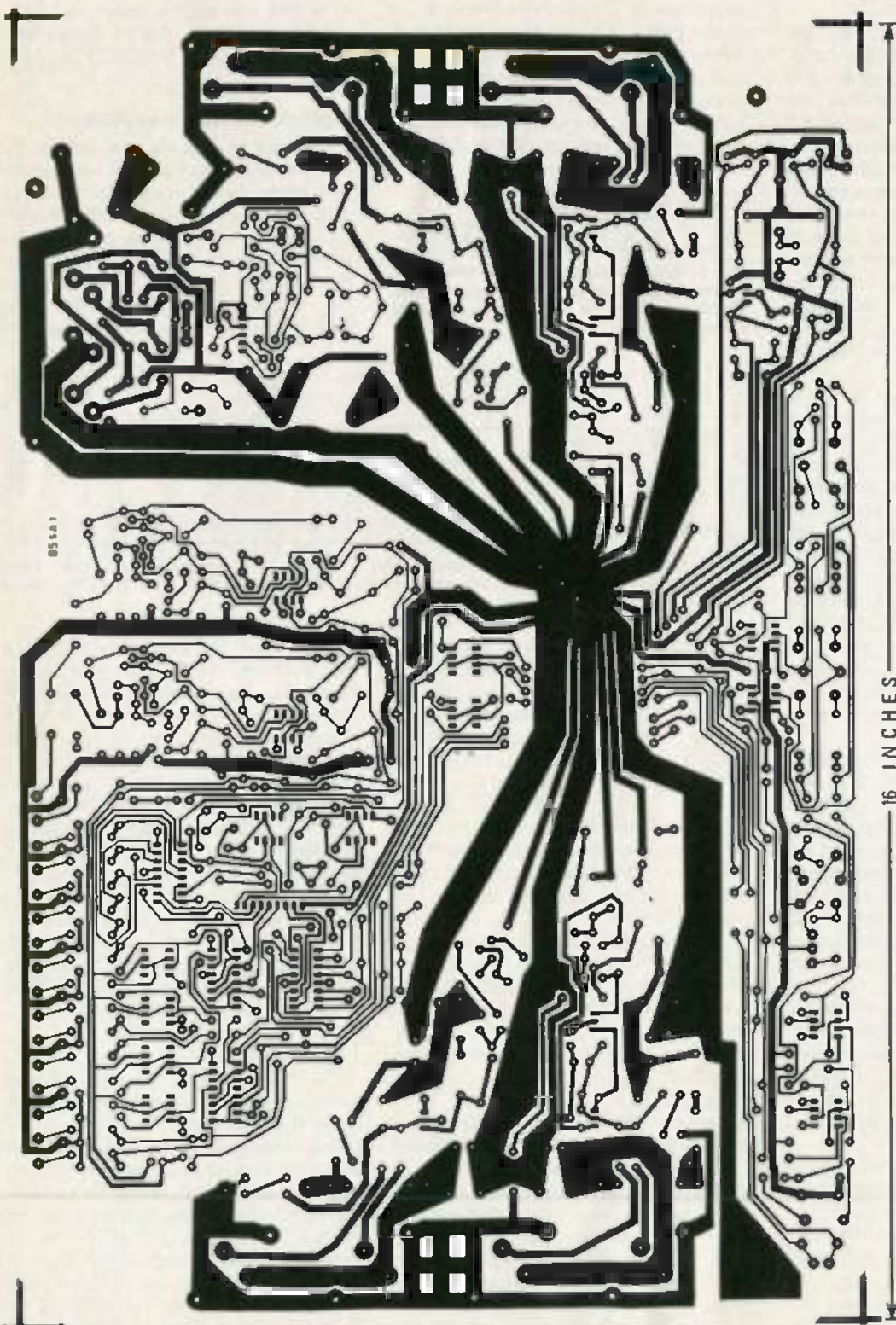

BECAUSE OF ITS LARGE SIZE, the PC pattern for the main board of the FEY power amp is shown here half sized. Also, the board is shown as a direct (not X-ray) view. Thus, the pattern can not be used directly to etch a board.

One of the most difficult tasks in building any construction project featured in **Radio-Electronics** is making the PC board using just the foil pattern provided with the article. Well, we're doing something about it.

We've moved all the foil patterns to this new section where they're printed by themselves, full sized, with nothing on the back side of the page. What that means for you is that the printed page can be used directly to produce PC boards!

Note: The patterns provided can be used directly only for *direct positive photoresist methods*.

In order to produce a board directly from the magazine page, remove the page and carefully inspect it under a strong light and/or on a light table. **Look for breaks in the traces, bridges between traces, and in general, all the kinds of things you look for in the final etched board.** You can clean up the published artwork the same way you clean up your own artwork. Drafting tape and graphic aids can fix incomplete traces and doughnuts, and you can use a hobby knife to get rid of bridges and dirt.

An optional step, once you're satisfied that the artwork is clean, is to take a little bit of mineral oil and carefully wipe it across the back of the artwork. That helps make the paper translucent. Don't get any on the front side of the paper (the side with the pattern) because you'll contaminate the sensitized surface of the copper blank. After the oil has "dried" a bit—patting with a paper towel will help speed up the process—place the pattern front side down on the sensitized copper blank, and make the exposure. You'll probably have to use a longer exposure time than you are probably used to.

We can't tell you exactly how long an exposure time you will need but, as a starting point, figure that there's a 50 percent increase in exposure time over lithographic film. But you'll have to experiment to find the best method for you. And once you find it, stick with it. Don't forget the "three C's" of making PC boards—care, cleanliness, and consistency.

PC SERVICE

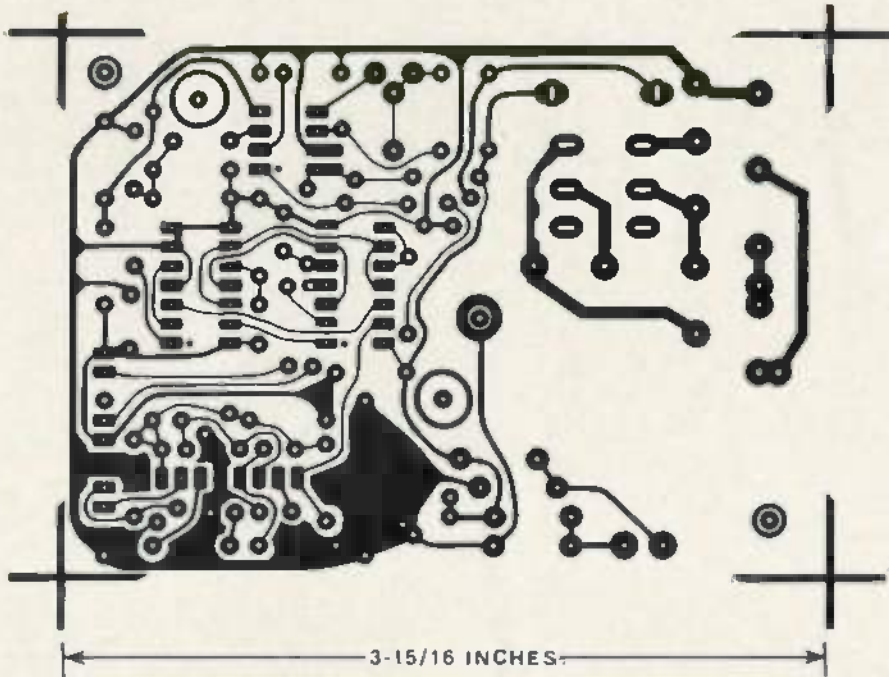

FREE YOURSELF from the tyranny of mechanical switches with our IR remote switch. The PC pattern for the receiver section is shown here.

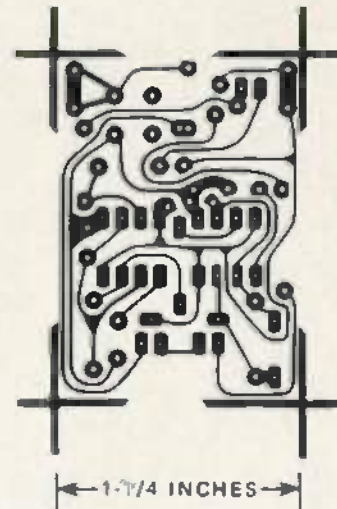

PC PATTERN for the IR remote switch's hand-held transmitter

PC SERVICE

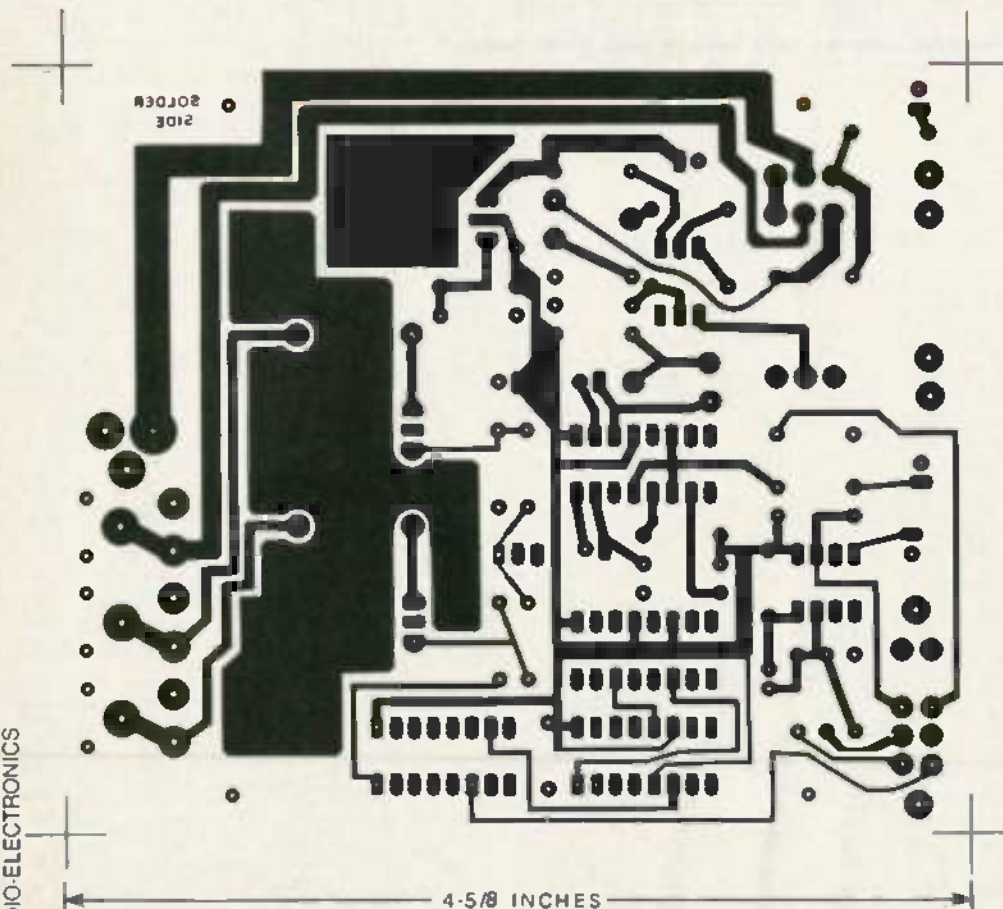

THE RADAR CALIBRATOR requires the use of a double-sided board. The pattern for the solder side is shown here.

PC SERVICE

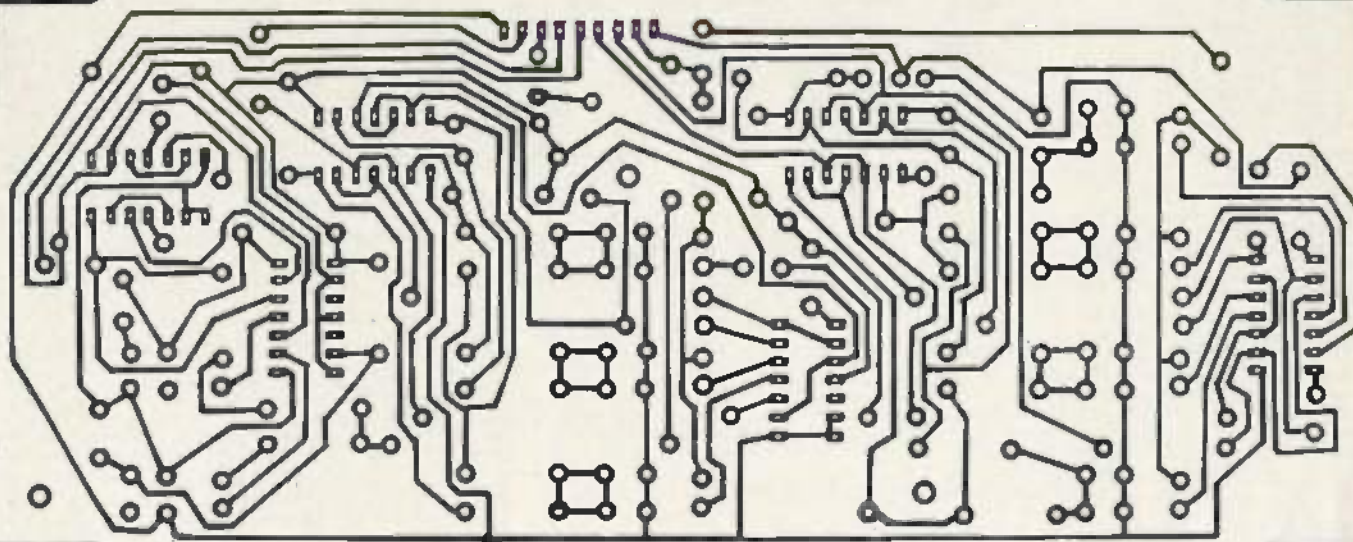

7-1/4 INCHES

THE CONTROLLER BOARD for the FET power amplifier can be built using this single-sided PC board. The pattern for the main board is shown on page 64.

PC SERVICE

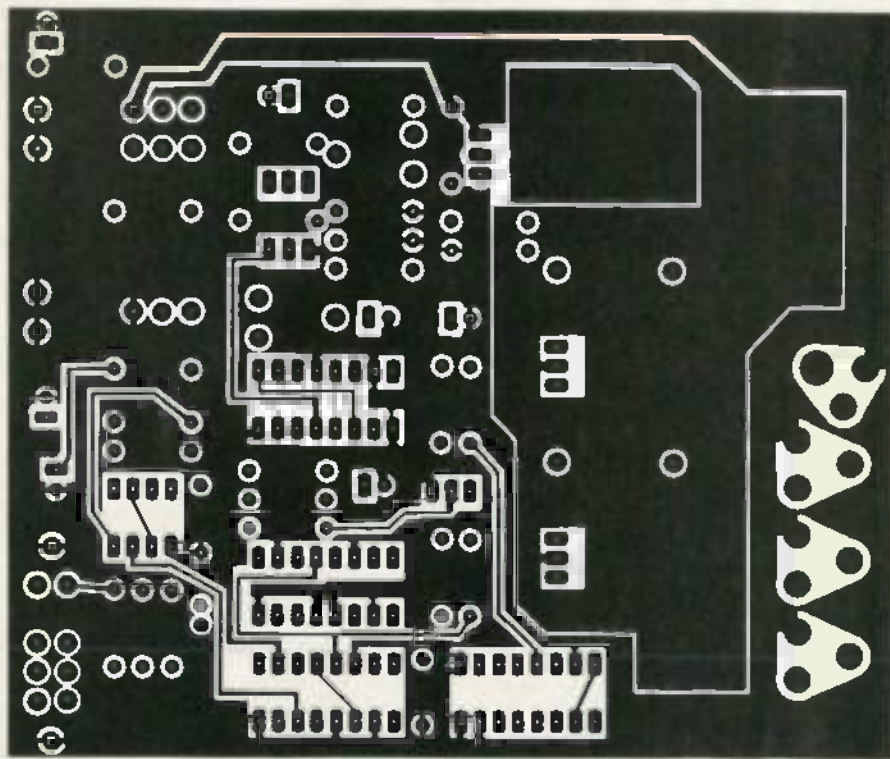

4-3/4 INCHES

THE COMPONENT SIDE of the double-sided radar calibrator board is shown here. The solder side is found on page 66.

COMPUTER DIGEST

A NEW KIND OF HITA AZ NE EGB ELECTRONICS PROFESSIONAL

RETROFITTING PRINTERS

Giving new life to an old workhorse

SPEECH SYNTHESIZER FOR THE COMMODORE

Teaching Your Computer To Speak

SINGLE TRANSISTOR

Switching Circuit Design

GERNSBACK

MP-80U-a

M3Y29

CONTENTS

Vol. 3 No. 8

August 1986

6 Retrofitting Printers

You can quickly and easily make your printer perform like the "big guys," and this article tells you, step-by-step, how to go about it. **Herb Friedman**

10 Speech Synthesizer

Got a Commodore 64? Here's how you can give it a voice and actually hear your computer talking to you. You'll also learn a lot about speech synthesis as well. **Ricardo Jiminez and Adrian Valle**

15 Single Transistor Switching Circuit Design

This handy program lets you use your computer to select critical components for designing these ubiquitous circuits. **Jeff Holtzman**

3 Editorial

4 Letters

4 Computer Products

14 Software Review



See Page 6

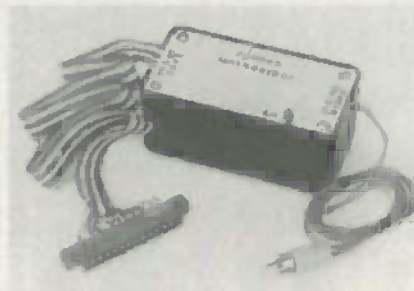

See Page 10

ON THE COVER

While the innards of any computer product might look like a confused maze, the article on retrofitting printers helps clear things up sufficiently so that you will have no problem in completing this work and having done so, you will have upgraded your printer. See page 6.

COMING NEXT MONTH

We've got an excellent mix of articles that should appeal to almost everybody. Leading off the next issue is an article on how to use your computer as a scanner for the CB bands that takes out all the usual frustration of channel-hopping. And you'll learn how to soup-up your computer so it performs as if it were supercharged. And to wrap things up, a build-it-yourself power controller that turns things on—and off—one at a time.

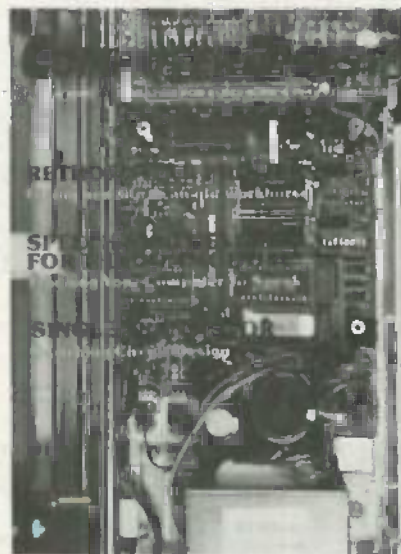

EDITORIAL

RM5241...

■ Don Stoner has been an electronics writer all his life. As such, he's been keeping his finger on the pulse of hobby electronics, and for my own part, when Don says something, I listen.

Right now, Don is saying something, and it's important. It's important to everybody that's interested in computers, so if you're reading these words, it's important to you. One of the newer areas of technology in computer science, is Packet Radio. You've seen articles on this same subject in **ComputerDigest**. And you probably realized that to take advantage of this, you require an amateur radio operator's license. If you have such a license, you probably were more than passingly interested in the article. If you didn't have, you may have wondered at the feasibility of getting such a license, just to make better use of packet radio techniques with your computer.

To oversimplify, packet radio permits you to transmit data from place to place without the use of a modem or telephone line.

Don Stoner has petitioned the FCC to create a band for use by the general public, for packet radio. It will operate at 500 kilobytes instead of 1200 baud, and most important, would make packet radio technology available to any computer owner without his having to take an amateur radio operating examination or possess such a license.

I haven't seen the details of Mr. Stoner's petition, but I'm certainly behind the spirit and general principles of it. I urge you to write to the Federal Communications Commission, Washington, D.C. 20554 and express support of RM5241. It's going to be good for us all.

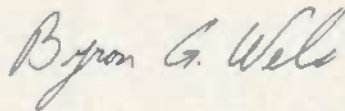

Byron G. Wels
Editor

ComputerDigest is published monthly as an insert in Radio-Electronics magazine by Gernsback Publications, Inc., 500-B Br-County Blvd., Farmingdale, N.Y. 11735. Second-Class Postage Paid at New York, N.Y. and additional mailing offices. Copyright © 1986 Gernsback Publications, Inc. All rights reserved. Printed in U.S.A.

A stamped self-addressed envelope must accompany all submitted manuscripts and/or artwork or photographs if their return is desired should they be rejected. We disclaim any responsibility for the loss or damage of manuscripts and/or artwork or photographs while in our possession or otherwise.

COMPUTER DIGEST

M. Harvey Gernsback,
editor-in-chief, emeritus

Larry Steckler,
EHF, CET; publisher & editor in chief

Art Kleiman,
editorial director
Byron G. Wels,
editor

Brian C. Fenton,
managing editor

Carl Laron,
associate editor

Robert A. Young,
assistant editor

Ruby M. Yee,
production director

Karen Tucker,
production advertising

Robert A. W. Lowndes,
production associate

Geoffrey S. Weil,
production assistant

Andre Duzant,
technical illustrator

Jacqueline P. Cheeseboro
circulation director

Arlene R. Fishman,
advertising director

Computer Digest
Gernsback Publications, Inc.
Executive offices
500-B Br-County Blvd.,
Farmingdale, NY 11735
516-293-3000
President: Larry Steckler
Vice President: Cathy Steckler

ADVERTISING SALES 516-293-3000

Larry Steckler
Publisher

NATIONAL SALES

Joe Shere
1507 Bonnie Doone Terrace
Corona Del Mar, CA 92625
714-760-8967

LETTERS

Last call

As you may know, SAMS publishes Computerfacts™ technical service data for the Timex-Sinclair 1000 ZX-81 computers as well as for many other personal computers, disk drives, printers and monitors. Our package for the Timex-Sinclair units is product #08969-6 with a \$19.95 retail price. We'd like to be included in your listing.—Dwayne Gott, Howard W. Sams & Co., Indianapolis, IN.

Mr. Gott, the list wouldn't be complete without offering the fine Sams publications. For those who need it, the full address is 4300 W. 62nd St., Indianapolis, IN 46268. And for you others who may have put off writing, move fast. We're ready to start preparing it now.

Which is best?

Our local computer club has been arguing about which is best,

WordStar, PeachText or pfsWrite. Which do you like best?—R.W., Bloomington, IL.

Never argue about politics, religion or word-processing programs. I use PeachText because I'm most-familiar with it, having learned on that. But recently I used a friend's new Tandy 1000 with pfsWrite, and had no problems. I like that too. I never did get to try WordStar.

Home made?

Why is it that home-brew projects always seem to look home-brew? Why can't they be "dolled up" to look like commercial equipment?—RT, Yuma, AZ.

They can—and should! But experimenters are usually satisfied if something they build just works. A little paint, some nice decals, and a little thought, and you can put together a project that looks as if you bought it!

Getting older

How long has ComputerDigest been around now? I certainly enjoy the concept of a "magazine within a magazine" and hope it continues.—S.B., Lyndhurst, NJ.

The first issue was published in May, of 1984. We're now in our third year, and still going strong. Thanks for asking. It certainly doesn't seem that long!

A saver!

I've been using my computer for quite a while now, and store everything to floppy disk. Result? A huge collection of disks, many of which contain information I no longer need. How can I save what I do want, and re-use those disks?—W.P., Miami, FL.

Simply transfer the desired info to a blank, formatted disk and then format the old disk for re-use. Just save the files you want to keep.

COMPUTER PRODUCTS

For more details use the free information card inside the back cover



CIRCLE 11 ON FREE INFORMATION CARD

PORTABLE COMPUTER PROTECTION, is provided by the Modern/Power/Static/Pac model MPS-1, which combines broadband AC power filtering, extended range spike

suppression, modem RF filtering, modem spike suppression, and a static discharge plate.

Power is available from a conventional three-prong outlet and a CEE-22 universal portable computer power connector. A 6' power cord is provided. Modem connection is through standard modular RJ-11 connectors. Static discharge is integrally designed into the unit. The model MPS-1 is priced at \$199.95.—**Electronic Specialists, Inc.,** 171 South Main Street, Natick, MA 01760.

DISPLAY ADAPTER, The Modular Graphics Card®, achieves complete compatibility because it looks like an IBM color graphics card to a PC system and its software and supports PC-compatible monochrome, RGB color, or composite monitors. Monochrome monitors portray colors as shades. The Modular Graphics Card displays up to 16 colors (on color monitors; up to 16 shades on monochrome monitors),



CIRCLE 12 ON FREE INFORMATION CARD

full-screen graphics, high-resolution text, and flicker-free scrolling.

Documentation includes tables of jumper and DIP-switch settings for optimum results from most popular monitors; for monitors not listed, a special software utility (also included) determines settings based upon on-screen displays. The card includes connectors for a light pen and an RF modulator. In addition, the card comes with RAM disk and print spooler software.

The Modular Graphics Card is priced at \$395.00.—**Paradise Systems, Inc.,** 217 East Grand Avenue, South San Francisco, CA 94080.

TAPE BACKUP SYSTEM, model *WD60Ti*, is a 60-megabyte, 1/4" internal, tape-backup system that enables IBM, PC, XT, AT, and certain compatible users to backup data from a hard disk.

The model *WD60Ti* comes with menu-driven, user-friendly software utilities; it draws its power from the host CPU's power supply, and does not require any additional power supply when operating inside an IBM PC AT. It uses a standard QIC-36 interface.

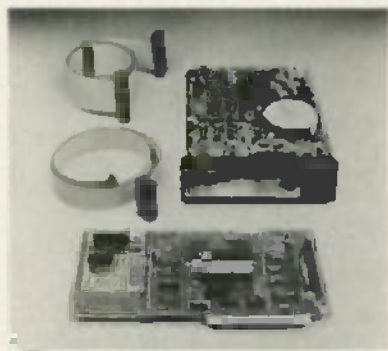

CIRCLE 13 ON FREE INFORMATION CARD

Mirror-image backup with the model *WD60Ti* takes only one minute per 5-megabytes. The unit also performs selective file backup, which saves tape space and allows the user to select what data to backup. The model *WD60Ti*'s built-in intelligence means that the user does not have to remember the last file modified to back it up. The model *WD60Ti* has a suggested retail price of \$1495.00.—**Western Digital**, 2445 McCabe Way, Irvine, CA 92714.

IN-CIRCUIT EMULATORS, are designed especially for Repair Technicians and Design Engineers. Small and compact (3" x 3" x 1/4"), these high-function emulators draw their power from the target system. (Optional power supplies are available with some models.) Since they plug right into the design board, the user gets full-speed emulation—with none of the attendant target disturbance inherent in traditional emulator designs.



CIRCLE 14 ON FREE INFORMATION CARD

Despite the small size and low price (models start at \$500.00) these emulators are powerful. Their two-micro-processor design offers the user access

to all memory addresses, software breakpoints, print points, both Hex and ASCII displays, assembly and disassembly of memory, and the ability to modify a memory location (or fill RAM w/constant) and read and load Hex files.

In addition the IAM In-Circuit Emulators provide the user with easy-to-use commands that execute, delay, and/or repeat instructions for thorough system testing. Models presently available are the 8085, 8088, Z80, and the model NSC800.—**IAM**, PO Box 2545, Fair Oaks, CA 95628.

FONT UTILITIES, for the Hewlett-Packard LaserJet Plus includes the *FontGen Utility*, the *Font Printer Utility*, and the *Landscape Utility* (shown).

The *FontGen Utility* is a font editor/generator that allows HP users to modify existing downloadable fonts and to create new font designs. The user can design special symbols, such as logos, signatures, or technical symbols and add them to a font. Characters from different fonts can be combined. The user can also alter existing fonts using func-



CIRCLE 15 ON FREE INFORMATION CARD

tions such as italicize, enlarge, reduce, or reverse image. The *FontGen Utility* has a suggested retail price of \$250.00.

The *Font Printer Utility* allows the HP user to print a hard copy of the character's bit map, as well as a listing of the components, such as the baseline position or left boundary. A single character, or a range of, can be displayed using the laser printer or a standard printer. The *Font Printer Utility* has a suggested retail price of \$50.00.

The *Landscape Utility* rotates characters, allowing a typeface to be used in the landscape mode. The software also revises the font header and character header, providing the user with a landscape version of any downloadable font. The *Landscape Utility* has a suggested retail price of \$50.00.—**VS Software**, 2101 South Broadway, PO Box 6158, Little Rock, AR 72216.

ACTION/STRATEGY GAME, *Beach-Head II*, is subtitled, "The Dictator Strikes Back."

Beach-Head II features true action for two players or one player against a com-



CIRCLE 16 ON FREE INFORMATION CARD

puter opponent. The game has multiple playfields, scrolling playscreens, hi-res graphics, various difficulty levels, and a "practice" mode. It is available on disk with a price of \$34.95.—**Access Software Inc.**, 2561 South 1560 West, Woods Cross, UT 84047.

PROFESSIONAL COMPUTER, the 1-800-Floppys, model *XT*, is designed for the experienced computer user; it is a dual disk drive, 640K, IBM-compatible personal computer, and comes with everything needed to run IBM-compatible software packages. There is a 135-watt



CIRCLE 17 ON FREE INFORMATION CARD

power supply, TTL monochrome monitor with a Hercules-type graphics card, eight slots for adding boards, a parallel port board plug, and a Keytronics-type keyboard.

The model *XT* comes with a 120-day warranty, which includes all parts and labor, and the customer may use the system up to 30 days in order to test its compatibility with his or her software. Should it prove incompatible, the customer is entitled to a complete refund, including return freight charges. The model *XT* is priced at \$999.00.—**1-800-Floppys**, 22255 Greenfield Road, Southfield, MI 48075.

RETROFITTING PRINTERS

Making new printers even better.

Herb Friedman

■ Unlike the printers that use typewriter-style elements with fully-formed characters, such as a daisy wheel, a matrix printer uses a pattern of dots to create characters and graphic symbols. In the low-cost printers used with personal computers the dots are generated by 7 to 24 solenoid-activated wires contained in a print head. Regardless of how the electromechanical system moves the printhead and "fires" the wires to produce printed dots, the decision as to how to move the print head and what wires to "fire" to create a specific character or graphic is generated by a microprocessor in the printer. The programming for the actual character/graphic pattern is stored in one or more ROMs; or in RAM when the printer lets the user design his own character set (font). In some modern printers the user can combine characters stored in ROM with user-generated characters stored in RAM.

Often, the difference between printers and character sets is the ROM, all else is the same. For example, the Epson MX-80 printer originally provided the ASCII character set and the block graphics of the Radio Shack TRS-80 Model I computer. When the Model I was displaced as the number 1 personal computer a new generation of Epson MX-80, called the MX-80+, and a later model called the MX-80 Graftrax (or MX-80 III) provided the ASCII character set and italic characters.

The difference between models of the MX-80 was the ROM(s) programmed for the characters, graphics and functions. In later models the ROMs were programmed to provide a backspace, then a conventional underscore, super and subscripting, new graphics, and new printing enhancements.

Later, the MX-80 became the IBM Graphics Printer, and although the ROM provided the conventional ASCII characters and control codes, instead of the italic characters and Epson-type graphics, the printer was programmed for the IBM foreign character set, the IBM Greek and math symbol set, the special IBM characters, and two distinct character/symbol/graphic sets. The label on the panel now said IBM rather than Epson. The printer was still an MX-80, but by substituting an "IBM ROM" the printer now generated a new set of characters, symbols and graphics.

More than characters

The ROM generates more than characters and graphics; it determines the features that can be accessed through software-driven printer codes and—depending on the printer—the functions of the operating controls, which are usually the three pushbutton switches for the *ON LINE*, *FORM FEED* and *LINE FEED* functions. If you could program your own ROM you could force a printer to respond differently to

the three pushbuttons. You could, for example, program the ROM so that pressing the *ON LINE* switch three times caused the printer to automatically shift to double-width characters, while pressing the button six times might cause the printer to automatically skip over the perforations of continuous-form (pinfeed) paper.

Fingerprinting

If you could program your own ROM it wouldn't be worth the effort because for about \$60, you can retrofit most popular printers with a custom ROM kit called a "Fingerprint" (Dresselhaus Computer Products, 837 E. Alosta Ave., Glendora, CA 91740), which can make an old workhorse emulate the character/graphics set of the latest printers (really the IBM character set), provide the most popular operating features, and allow you to directly access the most popular printer functions through what is normally the three operating pushbuttons—rather than software.

Beep for special functions

A Fingerprint converts the printer's three operating pushbuttons into a special function selector. If you touch the *ON LINE* button, it switches the printer on or off line. Hold the button down for one second, and it switches the printer to Fingerprint mode and beeps. You are now able to select many printer functions by beeping the *ON LINE* button. The chosen function depends on the number of beeps.

If you're using an FX-80 printer and want proportional printing, from the chart supplied, you know three beeps means proportional. Press the *ON LINE* button for three beeps, then press the *FORM FEED* button which programs the printer for the beeped function, in this case, proportional printing. Pressing the *LINE FEED* button ends the beep programming mode and restores the normal functions to the buttons. You can stack several functions. For example, three beeps for proportional printing, then four beeps for emphasized printing, to produce emphasized proportional printing.

Custom Fingerprint retrofits are available designed to

use the particular capabilities of the most commonly used matrix printers: The Epson MX, FX and RX, the IBM Graphics Printer, The C. Itoh Prowriter I and II, the NEC 8023A, the Star Gemini 10 and 15, the Okidata Microline Series, and the Apple Dot Matrix printers.

Many functions

The functions you can program through Fingerprint depends on the printer. Because of improvements in printers, Fingerprint provides more features in later printers than in older models. For example, the MX-80 family of printers and IBM Graphics Printers provide:

BEEPS	FUNCTION
1	Reset
2	Compressed
3	Double-wide
4	Emphasized
5	Double-strike
6	Perforation Skipover
7	Left Indent
8	8 lines/inch
9	italics
10	Fine print

A more-modern printer such as the RX-80 and RX-80+ series can provide:

BEEPS	FUNCTION
1	LetterWriter(NLQ)
2	Condensed
3	Elite
4	Double-wide
5	Emphasized
6	Double-strike
7	Perf-skip
8	Left indent
9	Italics
10	Underline
11	Fine print
12	8 lines/inch
13	Paper out disable
14	Slash zero
15	8 1/2 inch paper

The LetterWriter function in the list is Near Letter Quality

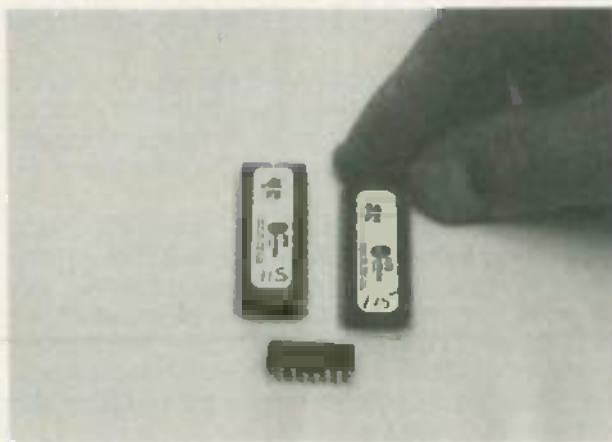

ON NEWER PRINTERS, three plug-in replacement ROMs form the entire printer retrofit. Substitute them for the existing ROMs and they provide up to 15 one-touch features including NLQ printing quality.

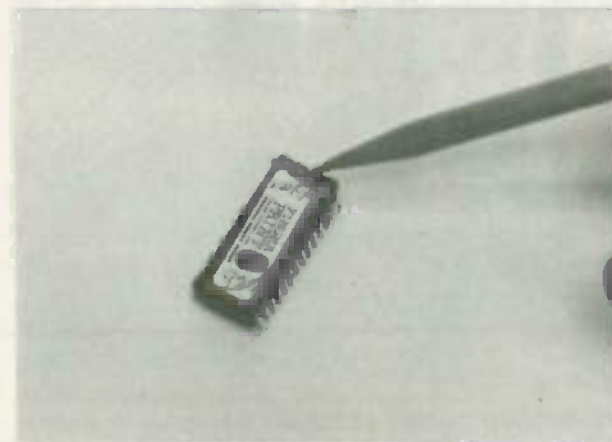

WHEN THERE ARE SEVERAL VERSIONS of a printer the Fingerprint ROM is pre-wired with a strapped resistor that is either left in place or cut with diagonal cutters. This avoids having to modify existing wiring in the printer.

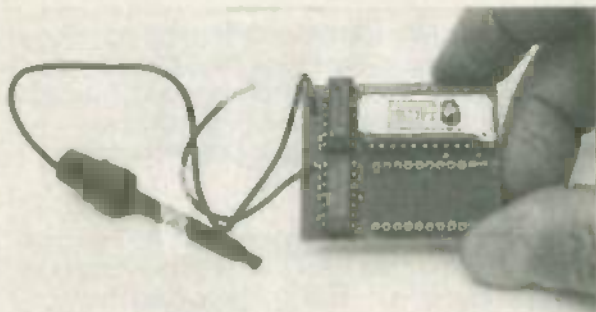

THE IBM GRAPHICS PRINTER and other MX-80 based models need a small printed circuit assembly that substitutes for the existing printer ROM. The parallel rows of terminals on the board create a 24-pin socket to which the original ROM is moved. The mini-clip provides a solder-free connection to existing printer wiring.

(NLQ), a character set which doesn't exist in this particular printer as supplied. In some printers, Fingerprint can synthesize both NLQ characters as well as the special IBM character set, graphics and symbols. If you have an older printer and an IBM-compatible computer your old printer will reproduce the IBM characters and graphics if Fingerprinted.

Stacking functions

You aren't limited to programming one Fingerprint function at a time. Any functions listed that aren't mutually exclusive can be stacked. Suppose you are printing the listing of a BASIC program to be stored in a ring binder. You could program emphasized characters for clarity, left margin offset to clear the rings and perforation skipover. Or if you'd like to print a 132 column spreadsheet with as many lines as possible on standard paper. Use Fingerprint to program both compressed/condensed characters and 8 lines/inch spacing. But you couldn't program *emphasized compressed characters* because they are usually mutually exclusive—the printer won't recognize

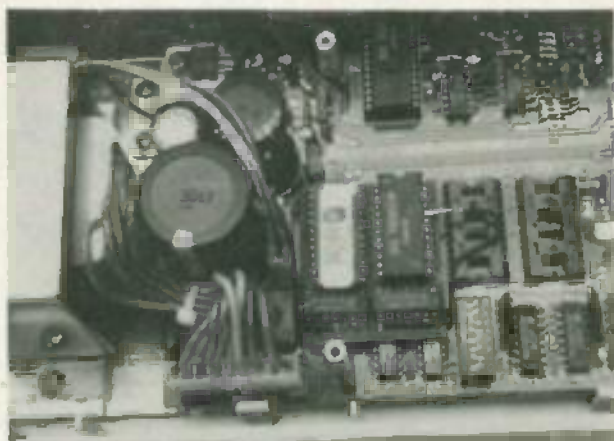

THE PRINTED CIRCUIT ASSEMBLY fits on top of existing hardware. Depending on the printer, the two empty sockets to the right of the Fingerprint might be filled with ROMs: Just ignore them. They don't get in the way because the circuit board sits above them.

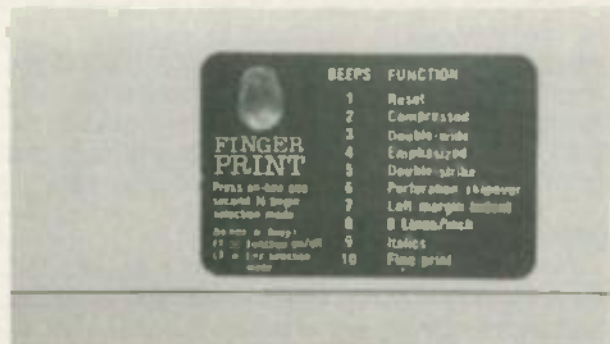

A LABEL AFFIXED TO THE FRONT of the printer tells what functions can be programmed directly from the printer's controls. This label for the IBM Graphics Printer shows 10 beeped functions.

the commands and will default to standard size for 10-pitch characters.

Turn them off

Fingerprint functions are turned off by entering the beep code a second time. If your Fingerprint retrofitted printer provides the option of conventional zeroes or slashed zeroes, when you want slashed zeroes, set the printer *OFF LINE* to stop the printing, program the slashed zeroes and resume printing. When you want to go back to conventional zeroes, stop printing, program the conventional zeroes and resume printing. The second slashed zero program turns the function off. This can be repeated as often as you like.

Installing the retrofit

A Fingerprint retrofit is a simple task because it only involves opening the case and replacing or moving one to three ROMs which are socketed—no desoldering is involved. Sometimes the retrofit is a direct swap for the existing ROM, in other cases it's a small printed circuit assembly that substitutes for the existing ROM, with the original factory-installed ROM moved to a socket on the PC board. In the newer printers, like the FX and RX-80s you simply swap ROMs. In the MX-080 based printers and the IBM Graphics Printer you remove the main ROM (there can be one to three), substitute a small printed circuit assembly, and install the original ROM in an empty socket on the circuit board. Then you connect a lead with a mini-clip to another IC terminal.

Of all the retrofits, the one with the printed circuit is the most difficult. "Difficult" being a relative term. The photos of a retrofit for an IBM Graphics Printer Fingerprint installation show it's an easy and not troublesome job if you don't rush it.

Imagine the printed circuit board is a new ROM. Using a large screwdriver, work the main ROM out of its socket, a little at a time so you don't damage the leads. Then seat the printed circuit in the now-empty socket, attach the mini-clip, and install the ROM in the empty socket on the board. If the printer had been one of the newer models, you would simply have discarded the old ROM and substituted the Fingerprint ROM.

Finally, install the case and apply a provided plastic sticker—listing the Fingerprint functions and their beeps, to the front of the printer. ◀▶



To 27 million Americans, this scene is a fairy tale.

Because 27 million American adults can't read a child's bedtime story, can't read a street sign, can't read...period.

Functional illiteracy is a problem that now affects 1 out of 5 American adults. It can rob them of a decent living; it can rob them of self-respect; it can rob them of the simplest of human pleasures...like reading a letter from a friend.

You can change that by supporting the fight against illiteracy. Your tax-deductible contribution to the Coalition for Literacy will be used two ways. First, it will help continue

the campaign to increase public awareness of the problem. Second, it will help us generate new resources for literacy.

To send a contribution, fill out the coupon. Or bill it directly to your credit card by calling 1-800-228-8813. Helping takes so little. And illiteracy can rob people of so much.

Volunteer Against Illiteracy.
**The only degree you need is a
degree of caring.**



Coalition for Literacy

Enclosed is my tax-deductible contribution for:

\$10 \$25 \$50 \$100 and above

Name _____

Address _____

City _____ State _____ Zip _____

Phone _____

MasterCard® Visa® Credit Card # _____

Expir Date _____ Signature _____

Make checks payable to: COALITION FOR LITERACY/MPA FUND

Please return to: Coalition for Literacy
Magazine Publishers Association Fund
50 East Huron Street
Chicago, Illinois 60611

SPEECH SYNTHESIZER

How to add a voice to your Commodore 64.

Ricardo Jimenez and Adrian Valle

■ If you want to increase the potential of your Commodore 64 with a speech synthesizer this project is for you. When your computer talks, you can have many advantages; for example, if you are processing information with numbers or letters, it will be a lot easier, because you will hear the number pressed on the keyboard without looking at the screen. And your children can learn to speak and spell by looking at the letters and numbers while they are listening to the correct pronunciation. Another advantage is that all the components for this project are available at any Radio Shack store.

Construction

The construction of the circuit is not critical, since only two chips are involved. You can assemble a working version on a solderless breadboard in less than two hours. We assembled the project in a small plastic experimenter's box. The 3.12 MHz crystal XTAL-1 can be replaced by a 3.14 MHz crystal, part number X004 for \$1.35, distributed by Digi-Key Corp. (P.O. Box 677, Thief River Falls, MN, 56701-9988).

Crystal XTAL-1 and capacitors C1 and C2 should be placed as close to IC1 as possible. A 12/24 pin card-edge connector was used to interface the electronic circuit with the C64 computer.

About the audio output; If you own the Commodore video monitor model 1701 you don't have to use an external speaker, just plug the audio output cables into the audio input of the monitor (located at the rear of the screen) via a phono plug. In this case the volume is controlled by the volume control of the monitor.

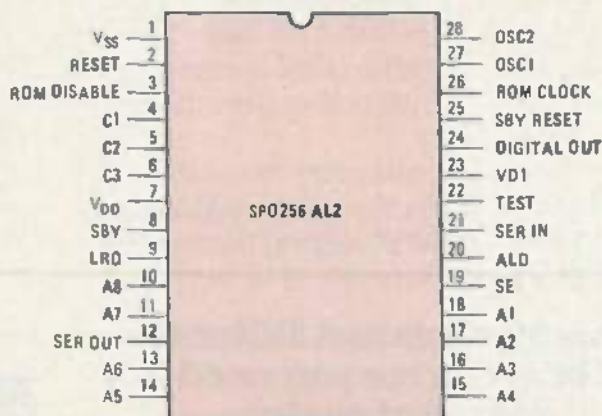
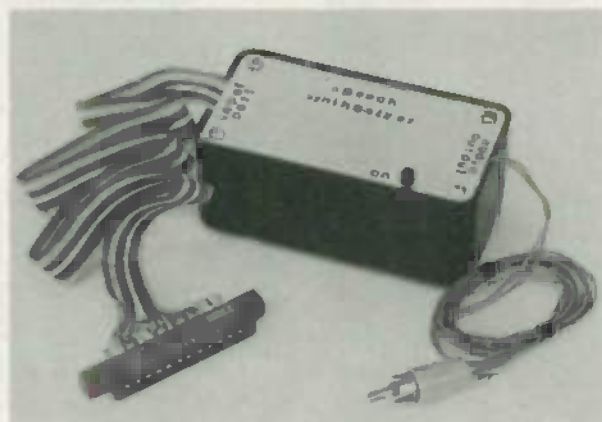

FIG. 1—PINOUT DIAGRAM for the SPO256-AL2. Refer to text for a detailed explanation.



THE COMPLETED SYNTHESIZER packaged and ready for use. As you can see, it's a compact unit that doesn't occupy much space considering the big job that it does.

Finally, the 5-volt DC power supply is provided by the Commodore 64 (pin 2 of the user port), which delivers a maximum current of 100 mA. Since the circuit has a current consumption of 90 mA, such power is suitable for this project.

About the SPO256-AL2

The speech processor (SPO256-AL2) is a single chip N-Channel MOS LSI device that is able, using its stored program, to synthesize speech or complex sounds. Figure 1 shows the pin configuration. We will look at the most important functions of the SPO256-AL2 which permit us to interface with the C64 computer.

A1-A8: 8-bit address which defines any one of 256 speech entry points. **ALD:** ADDRESS LOAD. A negative pulse on this input loads the 8 address bits into the input port and starts a speech command. This input is controlled by PC2 from the C64 computer.

SBY: STANDBY. Stays high until an address is loaded, then it goes low until the chip stops talking. This output indicates to the C64 computer when the chip is ready.

DIGITAL OUT: Pulse width modulated digital speech output which, when filtered by a low-pass filter and amplified, will drive a loudspeaker.

Let's start with some basic linguistic terms in order to understand how this project works.

Phoneme. This is the basic unit of distinctive sound. It represents different sounds depending on its position within a word. Each of these positional variants is an allophone of the same phoneme.

How to use allophones

When you use allophones you have to think in terms of sounds, not letters. And because each sound is acoustically different depending upon its position within a word, this method is called "Allophone Speech Synthesis." With this technique you can synthesize an unlimited vocabulary by addressing the 59 allophones plus 5 pauses in the appropriate sequence. Figure 2 shows the 64 allophone address table which are contained in the 16K ROM of the SPO256-AL2. The first column (decimal address) is the respective binary address for each particular sound. Since there are 64 addresses only, you will need six

DECIMAL ADDRESS	ALLOPHONE	SAMPLE WORD	DURATION
000	PA1	PAUSE	10MS
001	PA2	PAUSE	30MS
002	PA3	PAUSE	50MS
003	PA4	PAUSE	100MS
004	PA5	PAUSE	200MS
005	/OY/	Bo <u>y</u>	420MS
006	/AY/	S <u>ky</u>	260MS
007	* /EH/	En <u>d</u>	70MS
008	/KK3/	Co <u>mb</u>	120MS
009	/PP/	Po <u>w</u>	210MS
010	/JH/	Do <u>dg</u> e	140MS
011	/NH1/	Th <u>i</u> n	140MS
012	* /IH/	S <u>i</u> t	70MS
013	/TT2/	To <u>o</u>	140MS
014	/RR1/	R <u>u</u> ral	170MS
015	* /AX/	S <u>u</u> ceed	70MS
016	/MH/	M <u>i</u> lk	180MS
017	/TT1/	Pa <u>r</u> t	100MS
018	/DH1/	Th <u>e</u> y	290MS
019	/IY/	S <u>e</u> e	250MS
020	/EY/	Be <u>i</u> ge	280MS
021	/DD1/	Co <u>u</u> ld	70MS
022	/UW1/	To <u>o</u>	100MS
023	* /AO/	A <u>u</u> ght	100MS
024	* /AA/	H <u>o</u> t	100MS
025	/YY2/	Y <u>e</u> ar	180MS
026	* /AE/	H <u>a</u> t	120MS
027	/HH1/	H <u>e</u>	130MS
028	/BB1/	B <u>u</u> siness	80MS
029	* /TH/	<u>T</u> hin	180MS
030	* /UH/	<u>B</u> ook	100MS
031	/UW2/	F <u>o</u> od	260MS
032	/AW/	O <u>u</u> t	370MS
033	/DD2/	D <u>o</u>	160MS
034	/GG3/	W <u>i</u> g	140MS
035	/VV/	Y <u>e</u> ast	190MS
036	/GG1/	G <u>o</u> t	80MS
037	/SH/	S <u>h</u> ip	160MS
038	/ZH/	A <u>z</u> ure	190MS
039	/RR2/	B <u>r</u> ain	120MS
040	* /FF/	F <u>o</u> od	150MS
041	/KK2/	S <u>ky</u>	190MS
042	/KK1/	C <u>a</u> n't	160MS
043	/ZZ/	Z <u>o</u> o	210MS
044	/NG/	A <u>n</u> chor	220MS
045	/LL/	L <u>a</u> ke	110MS
046	/WU/	W <u>o</u> ol	180MS
047	/XR/	R <u>e</u> pair	360MS
048	/WH/	W <u>h</u> ig	200MS
049	/YY1/	Y <u>e</u> s	130MS
050	/CH/	C <u>h</u> urch	190MS
051	/ER1/	S <u>t</u> arter	160MS
052	/ER2/	B <u>i</u> rd	300MS
053	/OW/	C <u>l</u> ose	240MS
054	/DH2/	Th <u>e</u> y	240MS
055	* /SS/	V <u>e</u> st	90MS
056	/NH2/	N <u>o</u>	190MS
057	/HH2/	H <u>o</u> e	180MS
058	/OR/	S <u>t</u> ore	330MS
059	/AR/	Al <u>a</u> rm	290MS
060	/YR/	C <u>l</u> ear	350MS
061	/GG2/	G <u>u</u> est	40MS
062	/EL/	S <u>a</u> dd <u>l</u> e	190MS
063	/BB2/	B <u>u</u> sine <u>s</u>	60MS

FIG. 2—ALLOPHONE ADDRESS TABLE. This will prove extremely handy when setting up your synthesizer.

Input address pins to make all these combinations. The second column represents all the allophone sounds (except pauses PA1 to PA5). The third column shows how each allophone sounds in a sample word. The fourth column is the duration in milliseconds for each.

Allophones marked with an asterisk can be doubled; in the word "four" the "f" sound is long, therefore, this word must be formed as follows: "FF, FF, OR, PA5." Note that PA5 is not a sound, is a pause necessary to make the chip stop talking the last allophone.

Each allophone has its own address and sound. To demonstrate this let's see how it happens. The initial K sound (KK3, address 8), used in words like "comb" sounds different from the Ks in words like "can't." These small variations are due to the vowel which follow them, in this case, "o" and "a."

The computer controls the SPO256-AL2 with simple software. Let's look at the important instructions used in the programs. First we need to access the user port as follows. Pin C, D, E, F, H, and J (PB0 to PB5) in the output mode. Pins K and L (PB6 and PB7) in the input mode. This is made with the statement.

POKE 56579,63

Where PB0 to PB6 send the desired address to the speech processor IC1 (see Fig. 3). And PB6 receives the logic status of the STANDBY output (pin 8 of IC1). Remember that the decimal number 63 is equal to 00111111 in binary code. Therefore, when we send an address the \overline{A} L D input is activated and the chip (IC1) starts talking. Then the computer reads the user port to know the STANDBY status (PB6) which tells the computer when the chip is ready to be triggered again. The instruction PEEK(56577) reads the user port, but we need to read PB6 only which represents the decimal number 64. This is made by using the AND function. If PB6 is a logic "1" then the computer sends a new address.

Testing the speech synthesizer

As was mentioned before, the poke statement (line 20) is used to access the user port. Let's begin with the program shown in Fig. 4. With this program you can listen the particular sounds of the 59 allophones. The FOR-NEXT loop (line 30) is used to increment the value

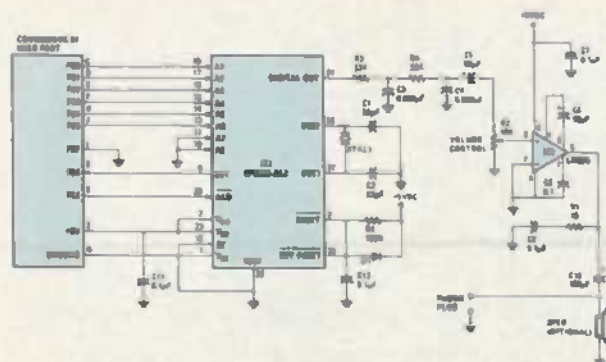

FIG. 3—SCHEMATIC DIAGRAM is relatively simple, uses only few components. Refer to the text for a full and complete explanation.

```

10 REM ALLOPHONES EVALUATION
12 REM BY R. JIMENEZ AND A. VALLE
20 POKE 56579,63
30 FORA=0 TO 63:PRINTA
40 POKE 56577,A
50 POKE 56577,0
60 PB=PEEK(56577)
70 F=PBAND64
80 IF F<>64 THEN 60
90 NEXT A
100 POKE 56577,1
120 END

```

FIG. 4—THIS SIMPLE, BRIEF PROGRAM allows you to evaluate the 64 available allophones.

of A from 0 to 63. The purpose is to use the variable A in the POKE statement (line 40) in order to address each allophone. The poke 56577,0 clears and prepares the user port for the next data. The PEEK statement (line 60) reads the user port, storing its value in the variable PB. Then PB is compared with the number 64 on the IF statement (line 80). If F is not equal to 64, that means that the speech synthesizer is not ready to receive new data. And the computer goes back to line 60 automatically. Otherwise, new data is sent.

The POKE Statement 56577,1 makes the chip (IC1) stop saying the last allophone. If you wish to listen to the allophones slowly, just press the (CTRL) control key.

Using the speech synthesizer

Making words with the SPO256-AL2 is easy, all you have to do is to look for the sounds you need from the Allophone Address Table. Figure 5 shows a program which makes the speech synthesizer say the sentence "I am a talking computer." This program works like the first one (fig. 4), using the same instructions to write and read by means of the user port. The only difference is that the data (lines 103-110) are going to be sent with the READ statement (line 70). Note that the data are written in decimal numbers. The words used in this sentence were taken from the dictionary included with the SPO256-AL2 package.

Figure 6 shows a routine that can be used for data processing. This routine makes the speech synthesizer say numbers from 0 to 9 when you press the respective key number. Lines 65 to 100 are used exclusively to assign the data found in lines 100 to 128 to the dimensioned variables A (I) and B (I,J). Here you can

```

10 REM I'M A TALKING COMPUTER
20 POKE 56579,63
30 FORJ=1 TO 27
40 READ A
50 POKE 56577,A
60 POKE 56577,0
70 PB=PEEK(56577)
80 F=PBAND64
90 IF F<>64 THEN 40
100 NEXT J
102 DATA 24,6,0:REM I
104 DATA 7,7,16,2:REM AM
106 DATA 24,2:REM A
108 DATA 13,23,23,2,42,12,44,0:REM TALKING
110 DATA 42,15,16,9,49,22,13,51,1,4:REM COMPUTER
120 RESTORE
170 FORI=1 TO 500:INEXTI:GOTO 45
200 END

```

FIG. 5—USE THIS PROGRAM, and you'll hear your computer actually say the words "I am a talking computer."

PARTS LIST

Resistors

All resistors 1/4 watt, 5% unless otherwise specified
R1—100,000 ohm
R2—10,000 ohm trimmer potentiometer
R3, R4—33,000 ohm
R5—10 ohm,

Capacitors

C1, C2—22pF., ceramic disc
C3, C4—0.022μF., ceramic disc
C5, C6—10μF., 10 volts, electrolytic
C7, C8, C9, C11, C12—0.1μF., ceramic disc
C10—100μF., 10 volts, electrolytic

Semiconductors

IC1—SP0256-AL2 speech processor (Radio Shack 276-1784)
IC2—LM386 audio amplifier (Radio Shack 276-1731)
D1—1N914 switching diode

Other components

XTAL-1—3.12 MHz crystal (see text)
SPKR—8-ohms (optional, see text)
12/24 pin card-edge socket (Jameco Electronics)
1.5 ft. - 14-conductor ribbon cable
Insulated phone plug (Radio Shack 274-321)
Experimenter box (Radio Shack 270-231)
Experimenter's IC periboard (Radio Shack 270-150)
28 pin IC socket
8 pin IC socket

```

12 REM DATA PROCESSING
15 REM BY R. JIMENEZ AND A. VALLE
20 PRINT "ISC"
30 POKE 56579,63
40 FOR I=0 TO 9
50 READ A(I)
60 FOR J=1 TO A(I)
70 READ B(I,J)
80 NEXT J,I
90 DATA 4,4,3,60,53,4 :REM ZERO
100 DATA 5,5,7,15,15,11,4:REM ONE
110 DATA 3,13,31,4 :REM TWO
120 DATA 4,29,14,19,4 :REM THREE
130 DATA 4,40,40,58,4 :REM FOUR
140 DATA 5,40,40,6,35,4:REM FIVE
150 DATA 8,55,55,12,12,2,41,55,4:REM SIX
160 DATA 8,55,55,7,7,35,12,11,4:REM SEVEN
170 DATA 4,20,2,13,4 :REM EIGHT
180 DATA 5,56,24,6,11,4 :REM NINE
190 V=V+1
200 IF V=10 THEN V=0 : PRINT "SC"
210 PRINT "VALUE OF X(";V;")"
220 GET C:IF C="" THEN 200
230 C=ASC(C)
240 IF C<48 OR C>57 THEN 200
250 C=C-48 : PRINTC
260 POKE 56577,0
270 FOR I=1 TO A(C)
280 POKE 56577,B(C,I)
290 POKE 56577,0
300 PB=PEEK(56577)
310 F=PB AND 64
320 IF F<>64 THEN 250
330 NEXT I : POKE 56577,1
340 GOTO 150
350 END

```

FIG. 6—THIS PROGRAM will cause your computer to clearly speak each number when the appropriate number key is pressed.

R-E Computer Admart

Rates: Ads are 2 1/4" x 2 1/4". One insertion \$825. Six insertions \$800 each. Twelve insertions \$775. each. Closing date same as regular rate card. Send order with remittance to Computer Admart, Radio Electronics Magazine 500-B Bi-County Blvd., Farmingdale, NY 11735. Direct telephone inquiries to Arline Fishman, area code-516-293-3000. Only 100% Computer ads are accepted for this Admart.



CALL NOW AND RESERVE YOUR SPACE

- 6 x rate \$800.00 per each insertion.
- Reaches 229,044 readers.
- Fast reader service cycle.
- Short lead time for the placement of ads.

Call 516-293-3000 to reserve space. Ask for Arline Fishman. Limited number of pages available. Mail materials to: Computer Admart, RADIO-ELECTRONICS, 500-B Bi-County Blvd., Farmingdale, NY 11735.

ICs PROMPT DELIVERY!!!

SAME DAY SHIPPING (USUALLY)

QUANTITY ONE PRICES SHOWN

OUTSIDE OKLAHOMA		NO SALES TAX	
256K	84Kx4	150 ns	\$4.37
256K	256Kx1	100 ns	4.87
256K	256Kx1	120 ns	3.35
256K	256Kx1	150 ns	2.95
128K	128Kx1	150 ns	4.55
64K	64Kx1	150 ns	1.40
EPROM			
27512	64Kx8	250 ns	\$28.00
27C256	32Kx8	250 ns	7.85
27256	32Kx8	250 ns	5.45
27128	16Kx8	250 ns	3.90
27C64	8Kx8	200 ns	5.10
2764	8Kx8	250 ns	3.45
STATIC RAM			
43256L-12	32Kx8	120 ns	\$50.00
6264LP-15	8Kx8	150 ns	3.10
6116LP-3	2Kx8	150 ns	2.10

OPEN 6 DAYS. WE CANSHIP VIA FEDEX ON SAT

Factory New, Prime Parts, Microprocessor Unlimited, Inc. (918) 267-4961

Prices shown above are for May 19, 1986

CIRCLE 187 ON FREE INFORMATION CARD

COMPUTER-AIDED CIRCUIT DESIGN for IBM-PC and 100% Compatibles

A Menu driven electronic design software tool for students, technicians, engineers. Program will design passive & active filters, attenuators, power supplies, amplifiers, etc. Has calculating programs for resistance, reactance, dB's, VSWR, and more. Includes design manual. MS/DOS 2.0-up, 128K memory req. Introductory price \$49.95 (Ohio only add 2.75 tax)

ESOFT SOFTWARE
P.O. Box 072134
Columbus, Ohio 43207

CIRCLE 188 ON FREE INFORMATION CARD

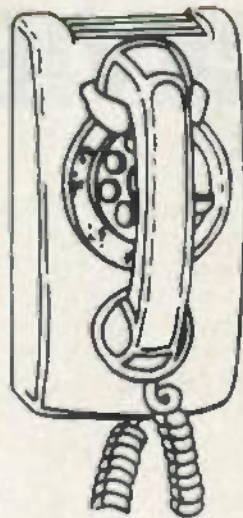

CALL NOW AND RESERVE YOUR SPACE

- 6 x rate \$800.00 per each insertion.
- Reaches 229,044 readers.
- Fast reader service cycle.
- Short lead time for the placement of ads.

Call 516-293-3000 to reserve space. Ask for Arline Fishman. Limited number of pages available. Mail materials to: Computer Admart, RADIO-ELECTRONICS, 500-B Bi-County Blvd., Farmingdale, NY 11735.

see how A (I) contains the data that the speech synthesizer will use to pronounce a particular word. In this case ten numbers can be pronounced. For example, A (I) holds the number 4 when the variable "I" has a value of 0. And the statement READ (line 70) is executed by the computer. That means that the word "zero" will be spoken by the speech synthesizer, by just sending the four data contained in the vector B (I,J) for values of "I" equal to zero with "J" varying 1 to 4.

The FOR-NEXT loops are used as an auxiliary to the statement READ. Observe how A (I) holds the first data to be used as a variable of the statement FOR (line 75), in order to read to exact quantity of data for each spoken number. Data from lines 110 to 128 are the decimal number values which we need to make the speech synthesizer talk. Vector A (I) will store the first data contained in such lines (4, 5, 3, 4, 4, 5, 8, 8, 4, 5), which as we said before indicates the data contained

in the vector B (I, J) respectively. We recommend that you compare these numbers with the allophone address table (fig. 2). For example, the data of line 110 forms the word "ZZ YR OW PAS" where the respective data are 43, 60, 53, and 4.

Lines 150 to 215 give an example of how to make the speech synthesizer more versatile. The screen will display "VALUE OF X (V)?" where V varies from 0 to 9.

The A (C) works as a variable in line 220 of the statement FOR, which means that "I" varies from 1 to the A (C) value, where C indicates the number that will be spoken. Line 217 POKES a zero so that the new data can be accepted without problems. Line 240 serves the same purpose. And lines 250 to 270 are used to read the STANDBY condition as we explained before.

Finally, the capacity of the speech synthesizer depends upon the imagination of the user. And we hope you enjoy this project as much as we did. ◀▶

SOFTWARE REVIEW

TELEPATCH—

■ It seems that just about everything, from business documents to a student's homework, to family announcements, is polished to perfection with a word processor. By the time one adds up the cost of the computer, disk drives and software needed for word processing they're into big bucks—way beyond what word processing is worth to a small service shop, or a student, or the typical family of 3.85 persons.

Because word processing isn't cheap, one of the best-selling professional-quality word processing systems has been the budget-priced Radio Shack Color Computer (known as the CoCo) and an inexpensive word processing program, Telewriter-64. Together, they provided most of the modern word processing features long before they were available for the IBMs, Apples, and other "office computers." Since Telewriter-64 can intermix tape and disk text files it far outclasses anything for small business and home-and-family use because the user can grow from a cassette-based word processor into a disk system without losing the cassette files.

The only problem with the CoCo system is that compared to the most modern high-performance word processors, such as WordStar 2000 and pfs:WRITE, Telewriter-64 lacks a few conveniences, such as a pure block move instead of a block copy and delete. Thanks to an enhancement software known as TELEPATCH, Telewriter-64's limitations are almost entirely eliminated, and in the process the CoCo has been made into a hassle-free single disk drive word processor (It is difficult to do word processing with a single-drive system.)

TELEPATCH (Spectrum Projects Inc., 93-15 86th Drive, Woodhaven, NY 11421) is a self-installing patch for the disk version of Telewriter-64. If you have a single-drive disk system it takes a number of disk swaps to install the patch, but when you're finished you have an upgraded version of Telewriter-64 (the source version isn't destroyed or modified) having thirteen new features, ten of which make the tight-budget CoCo/Telewriter into a powerhouse. The big ten are: 1) All disk I/O in memory (which permits the program disk to be removed); 2) A true block move; 3) Visible carriage returns, which are just great when setting up tables and charts; 4) Key repeat of all characters and the space; 5) Locked-on justified printing (doesn't turn off after a file has been printed); 6) A true RESET which permits a 64K Color Computer to be reset if everything else goes wrong without leaving the editor (no losing your work); 7) Lowercase off on boot (useful when writing BASIC programs); 8) Fast cursor movement (for zipping across

the screen); 9) Either overstrike or insert mode (original program provides only for insertion); 10) A type-ahead buffer for people who type faster than the computer can handle the data: if your typing gets ahead of the computer the screen will catch up.

The memory-resident disk I/O requires the most explanation. The problem with most word processing software used with computers having only one disk drive is that the data disk—the one that contains only text files—must be swapped with the program disk when using disk I/O disk routines, such as saving a file, or reading a file, or appending a file: frequent reads and appends can lead to considerable disk swaps. TELEPATCH eliminates the frustrations of disk swapping by moving all disk routines into memory along with the editing program so that it is never necessary to swap disks for disk I/O. The user can load the TELEPATCHed Telewriter-64, substitute the data disk for the program disk, and go through a complete editing session without having to remount the program disk.

One of the powerful features of the new disk I/O is that the user can instantly determine whether a save will be in binary or ASCII, selecting the one that will be most efficient at the time the document is saved to disk. For example, ASCII is generally preferred if the document will be run through a spelling checker, or is to be transmitted by modem; binary is recommended when maximum speed is wanted for writes and reads.

In order to retain the instant-access of the original Telewriter-64 the user-controlled TELEPATCH functions are command rather than menu driven. For example, a block move is instantaneous when CLEAR-T ("T" for transport) is pressed, similarly the insert/overstrike toggles when CLEAR-O is depressed.

TELEPATCH comes with a new loader that is written in BASIC so the user can conveniently configure the boot so the program comes up with the most desired features as the default. A complete list of pokes for the new features are provided along with the appropriate loader program line number. Among the user-set defaults are black/white or black/green screen, insert or overstrike mode, page numbering sequence, line spacing, lines per page, justified printing, "one page" printing, characters per line, upper, bottom, right and left margins, printer baud rate (300 through 9600), key repeat rate, repeat delay, fast cursor speed, number of disk drives in system (1-3), automatic case (upper or lower), disk verify, default disk drive, and ASCII disk menu.

TELEPATCH also permits the user to specify a disk stepping rate of 6 to 30 milliseconds. This means that you can get the maximum disk access speed if you have splurged for one of the latest model disk drives. On the other hand, it also means that the program will work with one of the original 30 mSec. "clunkers" you might have picked up surplus for something like \$25.

The primary limitation of TELEPATCH is that installing the disk I/O in RAM reduces the text buffer size from Telewriter's usual 24,889 characters to 20,793. If, for some reason, you need the extra RAM, or have a two drive system to begin with, you can install TELEPATCH without the disk I/O in RAM. ◀▶

SINGLE TRANSISTOR SWITCHING CIRCUIT DESIGN

Jeff Holtzman

■ Hobbyists dealing with digital circuits are terrified by interfacing. But for computers to do useful things, they must have a way of talking with outside circuits: relays, motors, lightbulbs, LED's, etc. Things aren't so bad when dealing with standard TTL outputs, but what do you do when you have to connect a 5-horsepower motor to a CMOS inverter? Doing that is simple; we'll show you how to do the design calculations, and we'll present a short BASIC program that does the work. One feature of that program is that after making the calculations, it outputs the value of the closest standard resistor.

To design a switching circuit, before doing any calculations, make sure that a single transistor will do the job. There are no calculations involved, just a little common sense. If your driving device is a 6522 VIA, or a Z80 PIO, or similar, and you want to control an NC (Numerical Control) lathe with a 5-horsepower motor, you'll need a few transistors to build up enough drive to control a relay large enough.

If you need to turn an LED on and off, you may be able to use a transistorless driving circuit. You may get by using just a current-limiting resistor, although doing that may not allow the LED to glow at full brightness.

If a one-transistor circuit will do the job for you, choose a transistor. Double the voltage and current requirements of your load device, and then search your databooks and catalogs for a transistor that meets those specifications. Find several that will do, in case your first choice is unavailable, or expensive.

Every transistor has a DC-gain factor, called HFE. Unfortunately, HFE varies from device to device, even between devices of the same type. HFE also varies with load and temperature. Since many applications aren't critical, a few assumptions can be made to get

things off the ground. Those will allow you to arrive at tentative values suitable for breadboarding; remember that slight adjustments may have to be made later.

With specifications handy, choose a value for HFE halfway between the minimum and maximum values given in the databook. If you don't have the specs, you can assume a value of 100 for a small-signal transistor, or 10 for a power transistor. That lets you estimate the value of the current-limiting resistor in the base circuit (R_1 in Fig.1). As base current is defined as the collector current over HFE, you can get the base current by dividing the collector current by 100, or by 10, depending on the type of transistor. Before finding the value of R_1 , we have to find the value of R_2 .

Making the calculations

To calculate the values of the resistors in the switching circuit shown in Fig. 1, work backwards from the load. You have to know how much current the load will draw, and its resistance, to calculate the voltage drop, $V(L)$, that will appear across it. According to Kirchoff's law,

$$V(CC) = V(L) + V(R_2) + V(CE)$$

$V(CE)$ is the voltage dropped across the collector and emitter leads of Q_1 ; that voltage is often about 0.3 volt, so it may be ignored. By making that simplification and rearranging our equation we find that $V(R_2) = V(CC) - V(L)$. We need the resistance of R_2 , and by Ohm's law that is equal to the voltage across R_2 divided by the current flowing through it, or $R_2 = (V(CC) - V(L)) / I(L)$. If the load is an LED, we can assume that $V(L)$ is 1.5 volt. If not, $V(L)$ must be expressed as $I(L) * R(L)$. In the latter case, the value of R_2 would be expressed as $R_2 = (V(CC) - (I(L) * R(L))) / I(L)$.

To calculate the value of R_1 , we use the value of HFE we found above. Since $HFE = I(C) / I(B)$, $I(B)$ can be expressed as $I(B) = I(C) / HFE$.

By Thevenin's law we know that $I(C)$ must equal $I(L)$, so $I(B) = I(L) / HFE$. Again, by Kirchoff's law we know that $V(IN) = V(R_1) + V(BE)$, where $V(BE)$ is the base-emitter voltage drop. For the sake of simplicity, we can assume that $V(BE)$ is zero, so the voltage dropped across R_1 must equal the input voltage. Therefore, the value of R_1 can be simply expressed as $R_1 = V(IN) / I(B)$. Since $I(B)$ can be expressed in terms of collector current, $R_1 = V(IN) / (I(C) / HFE)$.

The unknown quantities (R_1 and R_2) are expressed in terms of the known quantities, so it's time to plug the values into the equations and solve them. Rather than bang those values out your calculator, type the program shown in Listing 1 into your computer and save it for the next time you need to design a switching circuit.

The program provides features you may find convenient. For example, that program can be used to design a circuit with any driving voltage, but if you happen to be using TTL, the program assumes a value of 2.4 volts for $V(IN)$. Likewise, if you will be driving an LED, the program assumes a load current of 15 mA, and a 1.5 volt drop across the LED.

The program was written in MBASIC-80, and it should be simple to translate into other dialects of BASIC. The main routines have been written as

```

10 REM switching transistor circuit
20 REM design jh 10-22-85 for RE
30 FIRST = -1
40 PRINT CHR$(27);"*";
50 GOSUB 1000
60 PRINT
70 INPUT "Another? ", YESNO#
80 IF LEFT$(YESNO#,1) = "Y"
   OR LEFT$(YESNO#,1) = "y"
   THEN GOTO 50
90 END
1000 REM get end print data for
    switching circuit
1010 PRINT
1020 INPUT "Enter supply voltage
(VCC) in volts: ", VCC
1030 INPUT "Enter HFE of
transistor: ", HFE
1040 INPUT "Is load an LED
(y/n) ? ", YESNO#
1050 YESNO#=LEFT$(YESNO#,1)
1060 IF YESNO#="Y"
   OR YESNO#="y"
   THEN VL=1.5: IL=15: GOTO 1100
1070 INPUT "Enter load
resistance (RL): ", RL
1080 INPUT "Enter load
current (IL) in mA: ", IL
1090 VL=IL*.001*RL
1100 IL=IL*.001
1110 INPUT "Does TTL drive this
circuit (y/n) ? ", YESNO#
1120 YESNO#=LEFT$(YESNO#,1)
1130 IF YESNO#="Y"
   OR YESNO#="y"
   THEN VIN = 2.4: GOTO 1150
1140 INPUT "Enter driving
voltage (VIN): ", VIN
1150 IB=IL/HFE
1160 R1=VIN/IB
1170 RIN=R1:GOSUB 10000:R1=ROUT
1180 R2=(VCC-VL)/IL
1190 RIN=R2:GOSUB 10000:R2=ROUT
1200 PRINT:PRINT "R1 =";R1;
    "ohms, R2 =";R2;
    "ohms, I(B) =";IB:1000;"ma"
1210 RETURN
10000 REM get closest standard
    resistor value
10010 REM input = rin
10020 REM output = rout
10030 REM sf = scale factor
10040 REM 25 standard values follow
10050 DATA 1.0, 1.1, 1.2, 1.3,
    1.5, 1.6, 1.8
10060 DATA 2.0, 2.2, 2.4, 2.7
10070 DATA 3.0, 3.3, 3.6, 3.9
10080 DATA 4.3, 4.7
10090 DATA 5.1, 5.6
10100 DATA 6.2, 6.8
10110 DATA 7.5, 8.2, 9.1, 10.0
10120 IF NOT FIRST THEN 10190
10130 FIRST = 0
10140 AMAX = 25 : REM must equal
    no of entries in table above
10150 DIM A (AMAX)
10160 FOR I = 1 TO AMAX
10170 READ A(I)
10180 NEXT I
10190 X = RIN
10200 SF = 0
10210 WHILE X > A(AMAX)
10220 X = X/10
10230 SF = SF + 1
10240 WEND
10250 I = 1
10260 WHILE X > A(I)
10270 I = I + 1
10280 WEND
10290 IF X-A(I-1) <= A(I)-X
    THEN X = A(I-1) ELSE X = A(I)
10300 ROUT = X * 10^SF
10310 RETURN
10320 END

```

subroutines for easy integration into your programs. Lines 1000-1210 get the data and calculate the resistor values; lines 10000-10320 select the closest standard resistor values. Lines 10-90 drive the main routine following line 1000. Line 30 sets a flag for the standard-value routine, so that it doesn't read the data contained in lines 10050-10110 in every time a set of calculations are made. Line 40 clears the screen of my CRT (an ADM 20); you'll probably have to use another method.

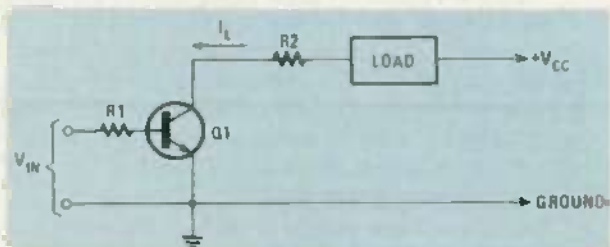

FIG. 1—R1 IN DIAGRAM ABOVE IS used for current limiting and must be estimated. (See text.)

If your BASIC doesn't have the WHILE ... WEND statements, you can simulate them by using an IF ... THEN statement and a dummy loop. For example, the code below could be substituted for the loop running from line 10210 to line 10240: 10210/IF X <= A(MAX) then 10250

```

10220 X = X/10
10230 SF = SF + 1
10240 IF X > A(AMAX) THEN 10210

```

That's about all there is to calculating the values of the resistors in this simple switching circuit. Of course, you should verify that the calculated values actually do the job before building 10,000 duplicate circuits. Also, note that the program prints the value of I(B) the circuit will draw. That was done as a protective measure. If your driving circuit is CMOS, and I(B) is greater than a milliamp or so, you'll have to do one of two things: use a Darlington, or add another transistor that will provide a bit of "preamplification." If you opt for a Darlington, you can use our program as is. ◀▶

SATELLITE TV



BOB COOPER, JR.
SATELLITE-TV EDITOR

Scrambling and TVRO systems

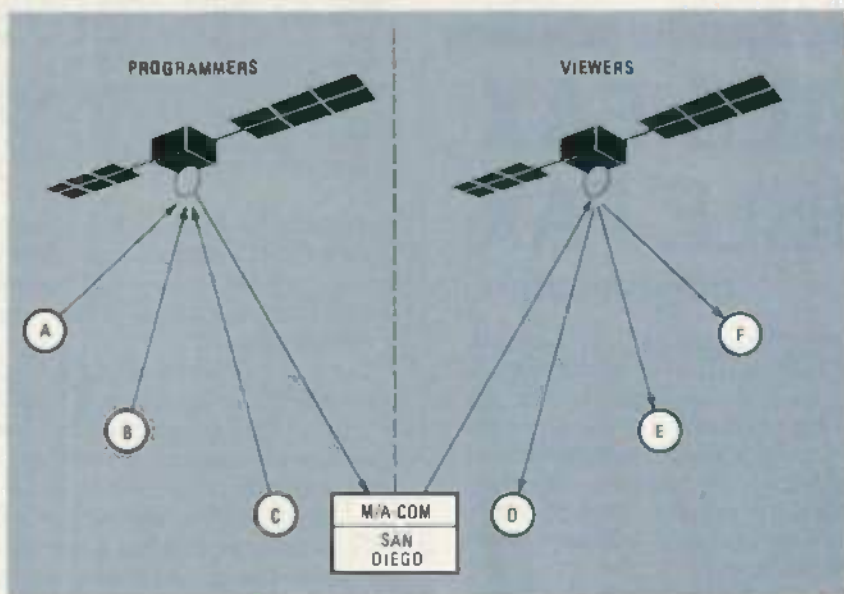

FIG. 1

M/A-COM HARDWARE HAS BECOME THE *de facto* standard in scrambling and descrambling. M/A-Com has accomplished that feat by being first to market a relatively secure scrambling system and by delivering both the uplink scramblers and the downlink descramblers in quantity. However, M/A-Com has suffered in the *home-TVRO* market.

The reason is that, before scrambling and descrambling became so important, M/A-Com was a major supplier of home-TVRO systems. Consequently, home TVRO owners had come to depend on M/A-Com, so they have been immensely dissatisfied with M/A-Com's role in the scrambling wars. But the scrambling furor has cost M/A-Com a significant amount of business not only because consumers refuse to buy, but because dealers refuse to handle M/A-Com products.

System overview

If you've just tuned in, here's a brief summary of how M/A-Com's system works. One of the key features of *Videocipher* descrambler is its addressability. Each descrambler, whether located at a cable-system supplier, a hotel MATV system, or a TV in a private home, has a unique, one-of-a-kind electronic address. That address allows each descrambler to be controlled individually by remote control from a central uplink location. This means that a descrambler can be sent private messages, or turned on or off.

As shown in Fig. 1, addressing is done by a master control center that is located near San Diego and operated by M/A-Com. Each program supplier is linked to the command center's computer via satellite; each programmer injects his command signals in his uplink signal at his own site.

There are two types of commands that can be sent to *Videocipher* units in the field. One command enables all subscribers in a programmer's "universe" to receive descrambled signals; the other enables only specific subscribers to do so.

The first type of command is called *open key*; it refers to a master code that is recognized by every *Videocipher* unit. Programmers don't normally use the open key, since it prevents them from using *Videocipher* as a gate counting or collection tool.

The second type of command is called *closed key*. When a *Videocipher* unit receives its own particular closed key, it will begin descrambling, and it will deliver viewable and listenable signals to the subscriber. The closed key is composed of digitally encoded numbers and letters. There are actually two stages of decoding: the first deciphers the address code, and the second deciphers the audio and video signals.

To date, most programmers who transmit scrambled signals began operating in the open-key mode. For example, super station WOR began full-time scrambling (in the open-key mode) on March 17th of this year. However, WOR switched to the closed-key mode in May, and that made their signal unavailable to home TVRO viewers.

The reason why WOR began operation in open-key mode is that additional time and equipment are required to broadcast signals in the closed-key mode. So the station began broadcasting in open-key mode and changed to closed-key mode when the equipment and programming was set up.

Legality

Some policies of the super stations, including WOR (New York), WTBS (Atlanta), WPIX (New York), WGN (Chicago), and KTVT (Dallas), have raised difficult legal questions. For example, by law, no TV station can itself directly purchase satellite transponder time to distribute its signals nationwide. The FCC considers that an unauthorized expansion of a station's broadcast coverage area. So, an intermediate company, a common carrier, must be used.

A common carrier is a firm that contracts with a cable system or

another business entity to pick up a broadcast signal at a distant point and then deliver it to the customer's premises. A Los Angeles TV station, for example, that is seen on a cable system in El Paso is transmitted from Los Angeles to El Paso by a string of common-carrier-operated microwave relay stations. Stations along the way may also tap the signal.

By law the common carrier is authorized to sell its services only to a special class of users. Cable-TV distributors and broadcast-TV stations belong to that class, but individual homes do not. Therefore, a

Interested In TVRO?

For nearly two years Bob Cooper has provided a no-charge kit of printed materials that describes the challenges of and opportunities in selling TVRO systems today. With the present intense interest in scrambling systems, Coop's CSD has made available a new no-charge service.

The SCRAMBLE FAX hotline is a 24-hour-per-day telephone service that provides accurate, detailed, and hard-to-find facts concerning the changeover to scrambling in the satellite communications industry. Information describing satellite receivers tested for scrambling compatibility, sources for authorized descramblers, wholesale rates of scrambling equipment and services—all are provided on the SCRAMBLE FAX hotline. There is no charge for that service, other than your long-distance telephone expenses. Simply dial (305) 771-0575 for a concise and timely three-minute capsule report that covers the latest in scrambling news.

SCRAMBLE-FAX SCRAMBLE-FAX

from Bob Cooper

IF satellite scrambling is important to you, here is a single source of timely, confidential information of great value: SCRAMBLE-FAX. Bob Cooper is routinely gathering all of the important scrambling information (who, what, when, where and how) and compiling it in printed form in an important newsletter called SCRAMBLE-FAX™. Sources for pirate decoders, reports on attempts to 'beat the system', full lists of who is scrambling, how and when. Each issue of SCRAMBLE-FAX is timely and new; but, each issue is a detailed encyclopedia of scrambling information and totally complete.

REPORTS on M/A-Com efforts to shut down pirate units, exporting of bootleg descramblers outside of the USA, complete listings of all (37+) channels now scrambling and those planning to scramble. The activities of DESug, the DES Users Group, and their progress on 'breaking' the Videocipher 'code', modifying receivers to accept Videocipher and much-much more.



WESTAR Communications/Westcom, the Toronto area alleged manufacturer of 'pirate decoders' for HBO/Showtime and other Videocipher type scrambled services reportedly has been sold to a new group of investors, all Canadian. The firm has been offering their pirate-type decoder unit for \$500 (US) for several weeks claiming it decodes all Videocipher scrambled video plus audio signals. Attempts to locate the firm other than through their 800 telephone number (1-800-265-5675) typically meet with failure and the firm is quick to explain that it would be inappropriate for them to identify their actual street address location (SCRAMBLE-FAX suggests you try 504 Incoques Shore, Oakville, Ontario, and 416/842-2877 as their non-800 telco).

EACH issue of SCRAMBLE-FAX is sent to you via AIR-mail the very day your order is entered. Simply call 305/771-0505 to order your copy (have VISA or Mastercharge card handy) or write for your copy enclosing payment for \$10 (US funds) to the address shown below. PLUS — each issue is 'supported' by a SCRAMBLE-FAX 'Hotline' telephone updating service.

DIAL 305/771-0575 anytime for a complete update on the status of scrambling. 'Hotline' recorded reports are provided by Bob Cooper as an 'instant update' to SCRAMBLE-FAX and carry fast-breaking news items of interest to the scrambling scene. But have your notebook and pen handy; each 'Hotline' report contains many telephone numbers and addresses you will want to retain!

SCRAMBLE-FAX by Bob Cooper

305/771-0505 or for free 'Hotline' service, 305/771-0575. To order by mail, send check/money order or enclose VISA/Mastercharge number and expiration date: CSD Magazine, P.O. Box 100858, Ft. Lauderdale, Fl. 33310

firm such as Eastern Microwave, who uplinks WOR's signal, says it cannot sell WOR's signals to individual homes because the law says it cannot do so.

Eastern Microwave is showing the cable-TV world that it is "cable-friendly," that it is anxious to court the favor of the cable operators by preventing home-TVRO owners from watching the signals it transmits. Of course that has generated considerable resentment on the part of both owners and sellers of TVRO equipment.

The TVRO industry's trade association, SPACE (the Society for Private And Commercial Earth stations), is asking the federal courts to forbid Eastern Microwave from scrambling its signals unless it also offers them to home-TVRO viewers. The case is complicated because the root of Eastern Microwave's contention that it cannot sell to individuals is a 1976 modification of the U. S. copyright law. The law makes a special provision for common carriers and establishes guidelines that appear to sanction Eastern's actions to date.

SPACE and the TVRO industry hope that, at the very least, the courts will suggest to Congress that the 1976 copyright law be revised and clarified. In the meantime, TVRO owners will be unable to receive the sports, movies, and other programs to which they had become accustomed. **R-E**

ROBOTICS



MARK J. ROBILLARD,
ROBOTICS EDITOR

Tactile sensing

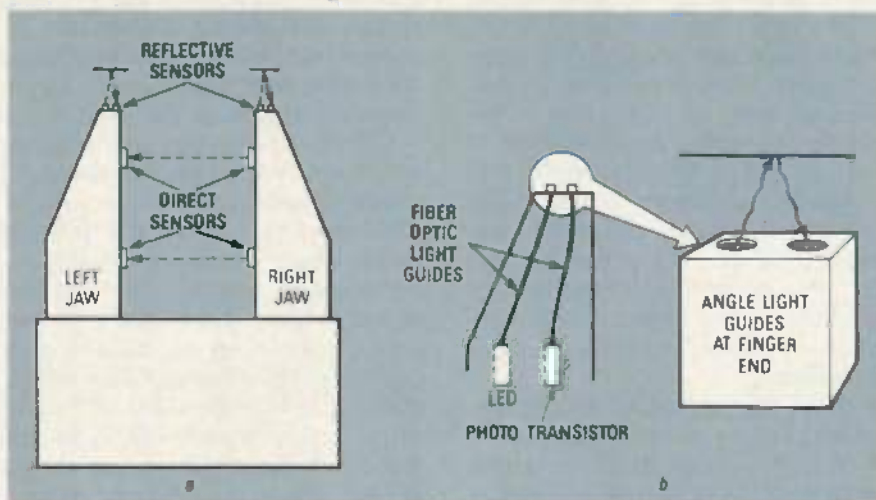

FIG. 1

MAN IS BLESSED WITH FIVE SENSES, AND one really proves its worth on a dark, cold winter morning. You roll out of bed and grope around for your slippers and bathrobe. Then you stumble into the kitchen, feel around for the light switch, and only then can you see what your hands and feet have been telling you. Oh that sense of touch!

Touch is important in robotics too. Most robots must move around to accomplish their tasks. Hence they need directions about where to go under different conditions. So they need to be able to acquire information about their surroundings. That information is obtained through a myriad of sensors—light sensors, sound sensors, and touch sensors, among others.

Different kinds of tactile information are important for different purposes. For example, often a robot must know how much force its gripper should apply to grasp

an object. If too much force is applied, an object may be crushed. If too little force is applied, the gripper may not be able to maintain contact when it tries to lift the object. In addition, bump sensors around the perimeter of the robot's base can be used to detect collisions. The underlying technology of both kinds of tactile sensing can be the same. Let's see how.

Limit sensing

The simplest touch sensor is the common microswitch. A microswitch is often activated by either a long flat lever or a lever with an attached roller. Pressing the lever "makes" the connection. Actuation force is relatively small, so it takes little force for the robot to "feel" whatever the switch is contacting.

A robot gripper might be equipped with two microswitches, one in each jaw. With no object between the jaws, both switches

would be open, but when an object is gripped, one or both switches will close. A computer interface could monitor the signals generated by those switches and it could use the various voltage levels to make decisions regarding the next action the robot should take.

Terence Thomas of Venice, FL sent a schematic diagram of a circuit that uses three microswitches. Two are used to detect obstacles around the perimeter of the body; a third indicates whether contact with the floor is being maintained. A floor sensor could be important to prevent a robot from making a perilous journey down a flight of stairs. Of course, the location of the floor sensor on the robot's body is critical. Two side-mounted microswitches provide direction control; when a switch on one side is activated, the robot turns in the opposite direction.

Optical sensors

Some sensing functions accomplished by switches can be accomplished better by another type of sensor. For example, rather than try to mount bulky, massive switches in the jaws of a gripper, you might use LED/phototransistor pairs, as shown in Fig. 1-a.

If you've ever been bowling, that setup should look familiar. The foul line sensor works on the same principle. It consists of a visible (or infrared) beam of light and a photo-detector. When your body breaks the beam, a light or a buzzer comes on.

Note that the sensors illustrated in Fig. 1-a are used in two different ways. The sensor pairs mounted between the jaws work like the

ELECTRONIC COMPONENTS



178 PAGE
FREE CATALOG

Manufacturers of Quality
Electronic Components

- BATTERY HOLDERS & CLIPS • COILS
- CAPACITORS • CONNECTORS • FUSES
- JACKS • KNOBS • LAMPS • PLUGS
- MICROPHONES • POTENTIOMETERS
- RELAYS • RESISTORS • SWITCHES
- TRANSFORMERS • SPEAKERS • LEDS
- SEMICONDUCTORS • RF COILS

OVER 15,000 DIFFERENT ITEMS IN STOCK!

MOUSER ELECTRONICS

2401 Hwy 287 No Mansfield TX 76063
Phone (817) 483-4422 TWX 510 601-0375

CIRCLE 117 ON FREE INFORMATION CARD

Be an FCC LICENSED ELECTRONIC TECHNICIAN!

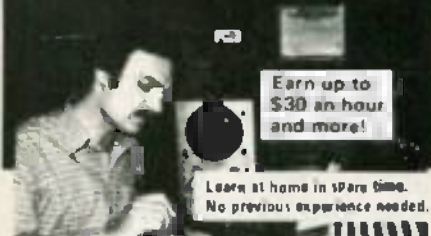

Learn at home in spare time.
No previous experience needed.

No costly school. No commuting to class. The Original Home-Study course prepares you for the "FCC Commercial Radiotelephone License". This valuable license is your "ticket" to thousands of exciting jobs in Communications, Radio-TV, Microwave, Computers, Radar, Avionics and more! You don't need a college degree to qualify, but you do need an FCC License.

No Need to Quit Your Job or Go To School
This proven course is easy, fast and low cost! **GUARANTEED PASS** - You get your FCC License or money refunded. **Send for FREE facts now. MAIL COUPON TODAY!**

COMMAND PRODUCTIONS

FCC LICENSE TRAINING, Dept. 90
P.O. Box 2223, San Francisco, CA 94126

Please rush **FREE** details immediately!

NAME _____
ADDRESS _____
CITY _____ STATE _____ ZIP _____

bowling alley's foul-line sensor: an alarm condition is raised when the beam is interrupted. The sensor pairs mounted on the front edges of the jaws work on the opposite principle: an alarm condition is raised when the beam from the LED makes contact with the phototransistor.

As shown in Fig. 1-b, each member of the reflective pairs should be angled slightly inward so that a nearby object will reflect light from the LED back to the phototransistor. The phototransistor would be connected to a computer interface or other controller.

The reflective pairs can provide more than just an object-is-present/object-is-not-present signal. The amount of light that is reflected provides an indication of how close the object is to the end of the gripper. So the output of the reflective sensors could be processed by an A/D converter and fed to a controlling device which would then be able to locate objects. A control sequence might go as follows.

- Move the gripper to the approximate position of the target object.
- Scan the gripper from left to right until the object is detected by the reflective sensor at the tip of the right jaw. The gripper must be open so far.
- Move the gripper right until the object is detected at the tip of the left jaw.
- Move the gripper left again until neither jaw detects the object. The object is centered left-to-right now.
- Move the arm forward until the first inside-the-jaw sensor detects the object.
- Move the arm forward until the second inside-the-jaw sensor detects the object.
- Retract the arm until neither sensor detects the object, or until both detect the object if it is large. The object is centered front-to-back now.
- Close the gripper.

There is one flaw in that sequence of gripper motions. As the last step, the robot is to close the gripper to capture the object. But how does the robot know when to stop closing? In some cases, the maximum gripping force of a lightweight arm can be applied to the

object. But that's not always the case. And how does the robot know when it has a good grip?

A force sensor

There are several ways to build a force sensor. One simple way is to use a spring and a microswitch. The spring is attached to a cable that winds around the shaft of a drive gear as motion occurs. The cable goes past the lever of a microswitch. When tension in the cable exceeds the actuation force of the microswitch, the switch contacts close. The device controlling the robot must then act on that signal. The spring in that sort of sensor must be selected carefully, according to the amount of force required to actuate the switch.

Other approaches use optical feedback. For example, the patented approach of Heath's *Hero 2000* uses two optical encoder disks. One is attached directly to the gripper, and the other is fastened by a spring to the first. As long as there is no resistance to the motion of the gripper's jaws, both disks spin together. But when an object is grasped, the disk attached through the spring slows down, while the directly-connected disk continues at its normal rate. The system's microprocessor can detect that speed difference by counting the slots etched in each disk; that information can be used to determine the force applied as well as the size of the object.

Other approaches use integrated circuits that incorporate a strain gauge and special pressure-sensitive resistive paint. In fact, a simple pressure sensor can be built from the conductive foam that MOS IC's are packed in. That foam has a finite, measurable resistance; when the foam is compressed, resistance decreases. By mounting a piece of foam between two metallic plates, a simple strain gauge could be built.

All those methods of tactile sensing comprise a field of inquiry that is as large as robotics itself. The science of tactile sensing is one in which the home experimenter might achieve a breakthrough by discovering new ways of measuring real-world quantities. So go to it! **R-E**

DRAWING BOARD

Bank-switching



ROBERT GROSSBLATT,
CIRCUITS EDITOR

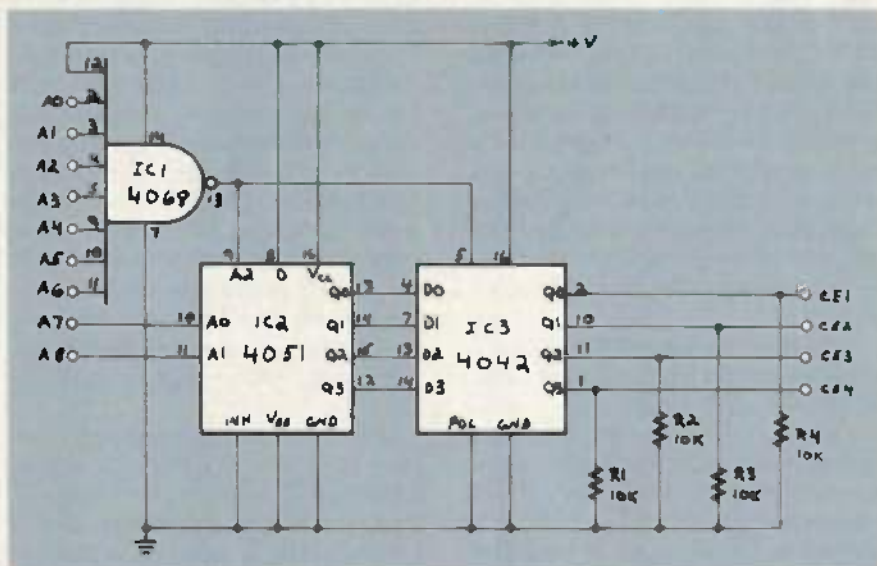

FIG. 1

WHEN WE LEFT OFF LAST TIME WE HAD just finished designing a basic memory-management circuit. If you breadboarded the circuit, you may have questions about how it works or how to use it. Before we discuss usage, let's discuss a few of the nitty-gritty details of circuit operation we couldn't get to last time.

Except for the addition of resistors R1-R4, the circuit shown in Fig. 1 here is quite similar to the circuit shown in Fig. 3 last time. We'll discuss why we need the resistors below; for now let's look at the circuit just in terms of logic.

Since the CMOS data selector we're using is a 4051, we can send either a high or a low to the selected output (Q1-Q4), depending on what the 4051's DATA input (pin 3) is connected to. In this case, it is connected to the positive supply rail.

When the low-order address

line (A0-A6) are high, IC1's output goes low. Then, depending on the state of A7 and A8, a high will be fed to one of the outputs of the 4051. That high will be clocked into four-bit latch IC2. That signal provides an active-high memory-enable signal.

Active-high or active-low?

Each of the four banks of our memory system is made up of four 5101's. The circuit was shown in Fig. 1 of the April 1986 issue of *Radio-Electronics*, and it contains one subtle error that could be confusing in light of the bank switching circuit presented here. The pins marked CE1 in that figure should be marked $\overline{\text{CE}}$. The active-low vs. active-high issue wasn't important there, but adding additional banks as we're doing now requires careful attention to the level of the enabling signal.

That aside, if you examine that

circuit, you'll see that we're doing memory banking there as well. Each bank is composed of two IC's, and the $\overline{\text{CE}}$ pin of each IC is used for bank selection. Our circuit uses a nine-bit address bus; the high bit of that bus allows us to switch 256-byte banks transparently, yielding a 512-byte system.

What we want to do now is add three additional 512-byte banks to the system. To do that, we'll have to use the 5101's other enable pins. If the IC had only one enable pin, we'd be faced with a fairly complex gating problem, but, fortunately for us, the 5101 has *three* separate enable pins. We discussed how they work in the April column.

We use pin 19 to select a 256-byte page in a bank, so we'll use pin 17 to select the bank as a whole (512 bytes). If that sounds confusing, it may help you to think of each 512-byte page as a separate section.

If you bring pin 17 of the 5101 low, the IC "goes to sleep." Actually, it goes into a low-power mode in which all data are retained and power requirements are reduced to less than 10 microamps. So, by using pin 17 as a bank selector, we get reduced current drain as a freebie! The point is that the banking circuit must put a high on the enable pin of the bank we want to select and a low on all the others. That's why we tie the DATA Input (pin 3) of the 4051 high.

The reason we need resistors R1-R4 is to ensure that the memory's enable pins are in a well-defined state. We wouldn't want those pins to float; data in the RAM might be garbled if the IC

ATTENTION! ELECTRONICS TECHNICIANS

EARN YOUR
**B.S.E.E.
DEGREE**



THROUGH HOME STUDY

Our New and Highly Effective Advanced-Placement Program for experienced Electronic Technicians grants credit for previous Schooling and Professional Experience, and can greatly reduce the time required to complete Program and reach graduation. No residence schooling required for qualified Electronic Technicians. Through this Special Program you can pull all of the loose ends of your electronics background together and earn your B.S.E.E. Degree. Upgrade your status and pay to the Engineering Level Advance Rapidly! Many finish in 12 months or less. Students and graduates in all 50 States and throughout the World. Established Over 40 Years! Write for free Descriptive Literature.

COOK'S INSTITUTE
OF ELECTRONICS ENGINEERING

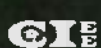

347 RAYMOND ROAD
P.O. BOX 20345
JACKSON, MISSISSIPPI 39209

CIRCLE 188 ON FREE INFORMATION CARD

SEE YOUR DEALER TODAY



FROM

'Firestik'
ANTENNAS
ACCESSORIES

HERE'S A TIP
THAT'S PERFECT!

AM/FM AUTO RADIO
AND CB

'Firestik' II

GOLDEN SERIES

BARE-HANDS TUNABLE
"NO TOOLS NEEDED"
HIGH PERFORMANCE ANTENNAS

ALSO ANTENNAS FOR
CORDLESS TELEPHONES
MONITOR SCANNERS

Dealer & Distributor Inquiries Invited
SEND FOR FREE CATALOG

Firestik Antenna Company
2614 East Adams Phoenix, AZ 85034

Name _____
Street _____
City _____
State _____ Zip _____

Serving the CB and
Communications Market Since 1962.

5-YEAR REPLACEMENT WARRANTY

CIRCLE 100 ON FREE INFORMATION CARD

were accidentally accessed for even a brief period of time. Since we need active-high enable signals, we need to use pull-down resistors.

To use the bank-switching circuit shown here with the memory circuit shown in the April column (*Radio-Electronics*, April 1986), tie pin 17 from all 5101's in each bank together and connect that line to one of the CE outputs of the circuit shown here. That gives us four banks of memory, each of which is selectable by flipping a soft switch located at an address ranging from 1FC to 1FF.

How can we select a memory bank? And how can we initialize the system properly? Those questions are interrelated, as we'll see. It would be difficult to generate a reset signal that would ensure that only one bank was enabled at power up. However, if we use our Z80 circuit as the system controller, the solution to the problem is simple.

When we designed the Z80 system, we made sure there was an RC-generated reset pulse produced at power-up. Among other things, that forces the Z80 to begin execution at location 0000. That being the case, to initialize the system all we have to do is have the Z80 flip one of the soft switches before it tries to access any RAM. To do that, the Z80 can execute any instruction that causes the address of the soft switch to be put on the address bus. The system's hardware will take over the task from that point.

Any of the Z80's "load" instructions is a good choice. For example, if the first instruction in your program is LD A, (01FF), the Z80 will obligingly put 01FF on the address bus and cause our circuit to enable one of the memory banks. Believe it or not, that's all you have to do to flip a soft switch. And it doesn't matter which instruction is used as long as it results in the appearance of a soft switch's address on the bus.

Other uses

We mentioned last time that there are several ways to set up alternate banks of memory in a system. Soft switches are a neat way to organize memory, but they

can be used for other things as well. And there are other ways of generating banking signals too. Let's look at some of those.

For example, if you're using only seven bits of data, you could use the eighth bit as a select line. Set the bit to talk to one bank of memory, and reset it to talk to the other. A more reasonable alternative would be to use an otherwise-unused Z80 control signal—an unused address line, perhaps, would serve well.

An externally generated signal may be a good choice in some systems. For example, if you're sensing and recording real-world data, some predetermined condition could be used to switch memory banks. For example, suppose you connected the bank switching system to a low-battery or power-failure alarm. A signal produced by a circuit of that kind could cause data to be transferred from volatile dynamic memory to battery-backed-up CMOS RAM. And yes, it's perfectly reasonable to mix two different memory types in one system.

Using that sort of scheme to capture data is a common practice. Commercial airlines, for example, use it in flight recorders, and a similar setup is used by recorders for unattended remote data gathering.

There are a few things to keep in mind when you set up a banked-memory system. The IC's you use in your switch circuitry must match or exceed your system's operating speed. The CMOS NAND gate we used is slow—about 150 nanoseconds. You could use a high-speed CMOS or TTL part to increase that speed by about a factor of 10.

If you're really interested in microprocessor system design, put the circuit together and connect it to the Z80 demo system we've been discussing. Of course, the Z80 has a 16-bit address bus, so switching 512-byte banks of memory is unnecessary, but you'll learn a great deal by making the system work. And that knowledge could be put to real-world use by designing a banking system that switches between 64K banks—and a memory system of that sort can be very useful.

R-E

SERVICE CLINIC

Replacing transistors



JACK DARR
SERVICE EDITOR

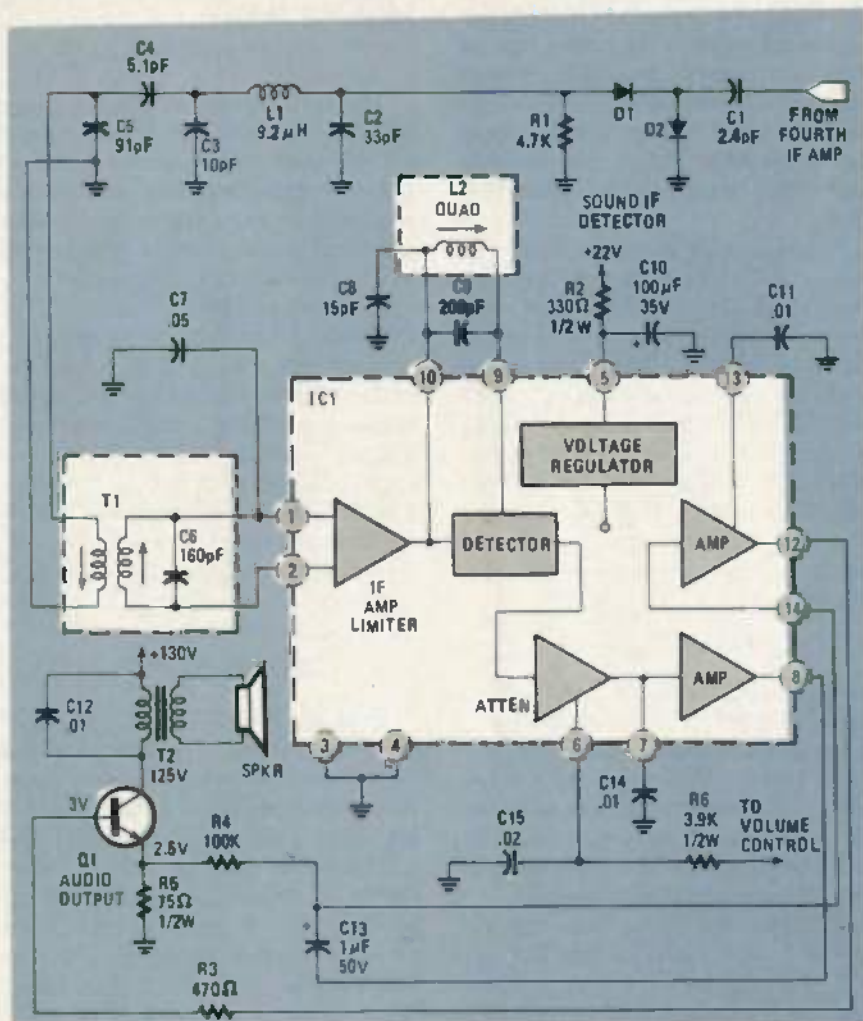

FIG. 1

SELECTING A SUITABLE REPLACEMENT for an unknown transistor is not as difficult as you might think. First get a good transistor substitution/specification handbook. Then, for example, if you're dealing with a low-level signal-amplifying stage, find a transistor that is classified as a general-purpose amplifier. The main parameters you'll want to be

wary of are voltage and current ratings, and cutoff frequency. A sync circuit, for example, requires a transistor with a fairly high cutoff frequency in order to prevent the sync signals from being rounded off. Just to be sure, examine the sync on a scope, and make sure that it looks clean. If not, try a higher-frequency transistor.

In many applications you won't have any trouble with cutoff frequency. Most general-purpose replacement transistors have cutoff frequencies high enough to prevent problems. However, to take another example, in a video output stage, make sure that your replacement has a peak voltage rating well above the applied B+.

A high-power circuit might use a power transistor, such as Q1 in the audio amplifier shown in Fig. 1, for output. You probably won't have any problem with cutoff frequency there, but power dissipation could be a problem. Therefore you'll have to make sure that your replacement can handle the voltage and current the circuit produces. Don't try to use a five-watt transistor in a fifteen-watt audio output stage!

A common problem is an audio output transistor that blows as soon as power is applied. The way to locate the problem is with a Variac. Before you turn the TV on, reduce the Variac's output to zero. Turn on the TV, and gradually bring the voltage up as you monitor the current flowing through the transistor. Many schematics indicate the amount of current that should be flowing.

Most audio stages work in either class-B or class-C mode in which quiescent (no input signal) current drain is far less than full-load current drain. So, if you measure any appreciable current drain with the Variac set for a low output voltage, remove power and locate the problem. Otherwise you may destroy several big, expensive power transistors. It takes only a skill-ionth of a second to blow out a

new transistor, so play it safe. Run it at reduced voltage until you're sure it's safe to run it at full voltage.

After you know that quiescent current is normal, try running the amp at about half volume. Current drain will be quite a bit more than with no signal, but check the value against the value specified in the schematic. Even if you have no service literature, one thing you can be sure of is that the maximum-current rating of your replacement transistor can't be exceeded! Try to run power transistors at half or less of maximum. That should help protect you from an unpleasant surprise!

Identifying an unknown device

Replacing a transistor is usually not too difficult a job to do—especially if you have a schematic of the set you're working on. Even if you have a schematic, however, you may not know much about a transistor, including its type or pinout. Some foreign sets, for example, use parts that you can't cross reference. So you may know whether it's an NPN or PNP (or FET, etc.) transistor, but little else.

If you have a schematic, verify each step outlined below as you perform it. If you don't have a schematic, and if you have no reason to suspect otherwise, start off by assuming that you're dealing with an NPN transistor in a common-emitter circuit.

First turn the power on; the transistor can be in circuit or out. Now measure the voltages where each lead connects to the PC board or chassis. If our previous assumptions were correct, the lead with the highest voltage is the collector, so the two remaining pins must be the base and the emitter. Using a scope you should be able to see some sort of signal where one lead connects; that's the base. The remaining lead is the emitter, which is usually connected to ground, possibly through a bias resistor.

Now and then you'll run into a set with an uncommon circuit. For example, in a common-base amplifier, the input signal is fed to the emitter. (I don't know why they do that; just to annoy servicemen, I think. You've gotta watch those engineers; they'll play some funny

tricks on you if you're not careful.) Be that as it may, in the absence of any circuit information, by tracing out the wiring of nearby components you can make a schematic diagram that will help you see what's going on. Servicing should be a snap after that. R-E

SERVICE QUESTIONS

SLOW GUNS

We are having a problem with an old Fleetwood color set that is defying logic. The symptom is all green on the left edge of the raster, caused by a slow coming on of the red and blue guns. Picture and color are otherwise perfect. We've checked every part in the RGB circuit, demodulator and video output.—P.D., Waterloo, Ont.

Anything that might be wrong in the signal circuits would be evident over the entire screen, not just one side. Your statement about the slow emission of the red and blue makes me think of a poor kine. Why not run a purity check to see if you can clean up the raster? Another thought: You might have defective blanking or filtering, showing up as green simply because that is the strongest component.

TRIPPING BREAKER

The circuit-breaker keeps tripping on this GE M772. After all the parts in the power supply checked good, I found that if I disconnected C1702A, one of the filters, the set worked, although the picture was weaving and was short on the right side.—R.A., Brampton, Ont., Canada

C1702A is the input filter capacitor, and without it in the circuit, B+ is reduced. Consequently, total current drain is lowered, and the breaker is holding. You could have nothing more than a faulty breaker, here. Try replacing it with a 2-amp fuse temporarily. If that doesn't do it, a variable transformer would make the job of troubleshooting a little easier.

NO VERTICAL DEFLECTION

I am having trouble with a Sylvania, model CC4152W. There is no vertical deflection. I have checked

waveforms up to the yoke, then I lose it. Help!—L.B., Washington, D.C.

I can understand your dismay. I studied the diagram for a long time before I found the yoke return. One has to follow the bottom leg of the vertical yoke winding, through the convergence board, exiting at V_{CC} , until he locates C342 and R342. Check them!

TRACTOR-RADIO PROBLEMS

A Bendix tractor radio, 8BT, came to the shop recently. The Sams schematic goes as far as 7BCX and then jumps to 17K2. Can any readers help?—Corwin Arndt, Box 178, Oshtosh, NE 69154

HOT FLYBACK

The 6JE6 current in this set is normal at 210 millamps. I have a good picture with good brightness and no picture shrinking. Yet, the flyback transformer runs hot to touch after 30 minutes of operation. What could cause this?—V.G.T., Phillippines

In every instance that I can remember, a hot flyback meant a defective flyback, and that usually also meant shrinking picture, focus problems, and low high-voltage. Heat can be a relative thing. What you feel is "hot to touch" may be normal heat build-up after 30 minutes of play. My advice is to do nothing for now. Just observe. If the flyback is on the way out, you'll know.

REPAIRING VCR'S

With the proliferation of VCR's in the home, there seems to be a real opportunity growing. In your opinion, what equipment is basic in VCR servicing?—J.J., Haddon Heights, NJ

The basic equipment is what every TV repair shop should already have. A good meter is, of course, essential, as is a wide-band scope and color generator. Then there is a matter of quality: An NTSC color generator is more useful than a keyed-rainbow generator and a triggered scope more useful than a conventional one. For high-output and high-grade VCR servicing, one would need to go into a frequency counter and sweep/marker generator for alignment purposes. An analyst, or signal-injector, would make the high-tech workbench complete.

continued on page 82

ANTIQUE RADIOS

Antique test equipment

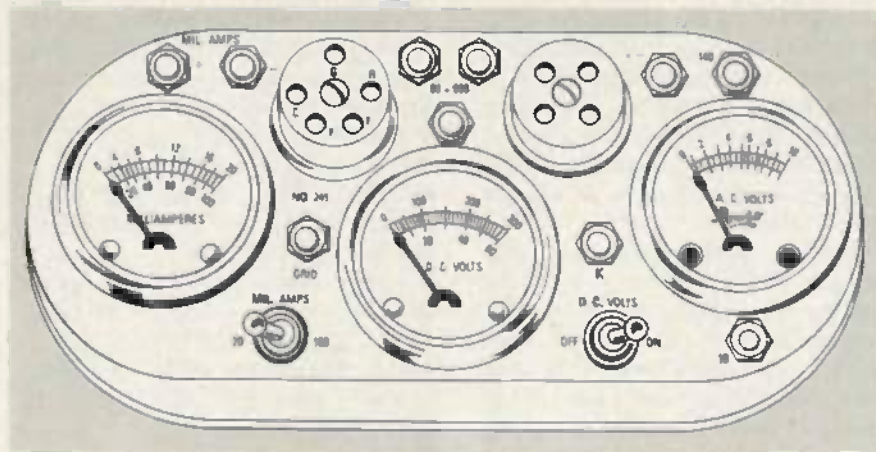

FIG. 1

TEST EQUIPMENT HAS BEEN NECESSARY as long as there have been radios, and advances in test equipment have paralleled advances in radio. But in many respects, early test instruments differ little from much of the equipment we still use every day.

Of course, when antique service equipment is mentioned, the first thing that comes to mind is the tube tester. However, many other types of service equipment were used in the early days, too. Because we've discussed tube testers in previous columns, we'll focus on other types of test equipment and early service techniques this time.

Typical problems

Opens and shorts were probably the most common problem with antique radios, but weak batteries and inadequate antennas were also very troublesome to the radioman of the 1920's and the 1930's. But during the 1930's battery problems were becoming less

common due to greater distribution of AC power. And built-in antennas helped increase signal pickup without the use of an outdoor antenna.

There were then, as there are now, specific procedures for troubleshooting. Those procedures could be learned in a technical or vocational school, or even in a correspondence school. Some schools pre-date the first commercially-scheduled broadcast.

There were two types of repairmen in the early days. The trained radio repairman or "radiotrician" (of which I am one) followed specific procedures for diagnosing various symptoms. The untrained man was referred to as a tube changer. No matter what the problem was, he would immediately begin changing tubes. The radioman of the 1920's needed to carry about a dozen tubes on a service call. Those tubes took up about as much space as 100 of the miniature tubes that became available later.



RICHARD D. FITCH
CONTRIBUTING EDITOR

Most early radiomen had little in the way of test equipment. And even a well-equipped shop didn't always have a well-trained service man. Often a radioman settled for one "pet" instrument which he mastered.

Among the equipment available was a shirt-pocket sized "illumination tester." That interesting device was very advanced for its day. It was handy for preliminary testing, anyone could afford it, and it could even test the spark plugs in your Model A! A built-in neon lamp could be used to indicate a short, an open, or the polarity of a DC voltage source.

Another valuable test instrument was the hydrometer. Yes, in the early days, when battery receivers were popular, the hydrometer was an important piece of test equipment. It is used to check the specific gravity of the electrolyte (the acid) in a battery. A weak "A" battery was the primary suspect when a radio appeared to be dead. Often a battery could be rejuvenated by adding distilled water. More than half of the problems with battery sets originated from the batteries, so most service calls were relatively routine.

And, in the later 1920's, a furniture touch-up kit was necessary to keep the elaborate cabinets that were being produced then in good shape.

Many early radiomen preferred working on battery-powered sets. They were used to them, and they felt safer working on a battery set than on an unfamiliar "electric" set. If a radio didn't operate after the batteries were serviced, the radioman would have to resort to

more sophisticated means of locating the problem.

To do that, he might use one of several test meters, or, more likely, a combination meter called an analyzer. The analyzer was the "in" piece of equipment for the radioman in the mid and late 1920's. An analyzer could cost \$10, which was a great deal of money at the time.

The analyzer, which is still popular (and still expensive) for TV and other servicing, combined several meters and a component tester. Part of the reason that the analyzer was popular in the early days was that few radiomen had a car to lug a complete kit of instruments and parts on a service call. Some analyzers were so complicated to use that many servicemen never got the full benefit of them. Many analyzers were transportable.

There were many styles of portable analyzers. The tester shown in Fig. 1, for example, measures about 8 inches across and it has a leather top in which probes and test leads could be stored. The instrument could be carried in a coat pocket. It allows you to measure voltage and current in several ranges; the two sockets are for testing four- and five-prong tubes.

It's easy to see how such a light, compact unit was suitable for many of the early radioman's needs on a house call. The power supply voltage(s) could be verified, tubes could be tested either out of circuit or in (by connecting a cable from the tube socket to the analyzer). And the continuity test (even today) is the easiest method of locating shorts and opens.

After batteries, tubes were the most likely suspect in a non-functional radio. Tubes could be checked in-circuit with an analyzer, or continuity could be measured between suspected filaments. Ohmmeters were not usually a separate instrument; often a small battery was wired in series with a voltmeter to check continuity.

Often a weak tube could be rejuvenated. There's a real art to rejuvenating tubes; except for rejuvenating picture tubes, that art has gone by the wayside. Not all types of tubes were worth rejuvenating; nor could all tubes be rejuvenated. Tube filaments that

were coated with oxide would emit electrons as long as some oxide remained. After the oxide evaporated, the remaining element required a greatly increased temperature to emit electrons, and that was impractical. That type of tube was usually disposed of with no attempt at rejuvenation.

On the other hand, tubes with thorium-coated elements could be rejuvenated several times. Even when the thorium coating was spent, rejuvenation was possible, because some thorium that had mixed with the metal in the filament could be brought to the surface to extend tube life. That process could be repeated until there was no thorium left. Early radiomen destroyed their share of tubes by applying an excessive voltage to the filament (a process known as flashing) trying to "wake up" some electrons that simply weren't there.

Flashing (and a similar, slower process called aging) was done with the B+ supply disconnected. That prevented the "new" electrons from being emitted right away rather than being stored for emission later. Tubes such as the WD11, the WX12, the UX171, and the UX227 have oxide-coated filaments; those tubes cannot be rejuvenated.

Even after restoring a set to minimal operation, the early radioman might find that the customer had tried to fix his own set by tampering with the set's alignment. One way of restoring alignment was to tune in a weak station and then slowly adjust trimmers for the best signal. A meter could be helpful in judging signal strength.

But for accurate alignment a test oscillator is required. Test oscillators that deliver modulated signals have been available since the 1920's. Some models then could operate from commercially-distributed AC, DC, and batteries.

Much early test equipment was well-built and housed in a fine cabinet. Much of it is still around and in perfect working condition. And it is as collectable as the antique radios we're used to talking about. Just make sure that the insulation on the wires is intact. Replace all suspect wires before attempting to use any antique.

As time passed, analyzers became even more important. Most radio components and terminals were moved under the chassis. Inserting test leads through holes in the tube socket became the only practical way to make measurements without removing the chassis. By 1930, a chassis might consist of three or more bulky sections that would require considerable effort to remove.

Haves and needs

Again, thanks to everyone who took time to write. Your suggestions and corrections are welcome. Please understand that I am unable to supply tubes, parts, schematics, etc. Try contacting one or more of the individuals and firms listed below for those.

- Maurer TV Sales (tubes), 29 S. 4th St., Lebanon, PA 17042.
- Byron Ladue (tubes and schematics), 13 Revere Drive, Rochester, NY 14624.
- John Grey (new and used tubes), 3348 Wildridge Rd. NE, Grand Rapids, MI 49505.
- E. G. Roundtree (parts and information), Box 269, Norris City, IL 62869.
- Antique Radio Tube Co. (tubes, parts, information), 1725 W. University, Temple, AZ 85281.
- The Vestal Press (books and information), Box 97, 320 N. Jenson Rd., Vestal, NY 13850.
- Scaramella (schematics), 37 Earl St. P. O. Box 1, Woonsocket, RI 02895-0001.
- Comtech Electronics (pre-1939 Rider manuals), P. O. Box 686, Wyandotte, MI 48192.
- Richardson Electronics (antique tubes), 3030 North River Rd., P. O. Box 424, Franklin Park, IL 60131, Attn. Ian Stewart.
- Alvin Sydnor (information), 806 Meetinghouse Rd., Boothwyn, PA 19061.
- Unity Electronics (tubes), P. O. Box 213, 107 Trumbull St., Elizabeth, NJ 07026.
- Carlos Queitoz (exchange parts and information), P. O. Box 1064, Belo Horizonte, MG Brazil.
- E. V. Schwartz (Firestone, Silverstone information), 4277 Motor Ave., Culver City, CA 90232.
- B. R. Pohue (information on antiques), Rte. 1, Box 786 No. 8, Thatcher, AZ 85552.

R-E

STATE OF SOLID STATE

"Chop-amps"



ROBERT F. SCOTT,
SEMICONDUCTOR EDITOR

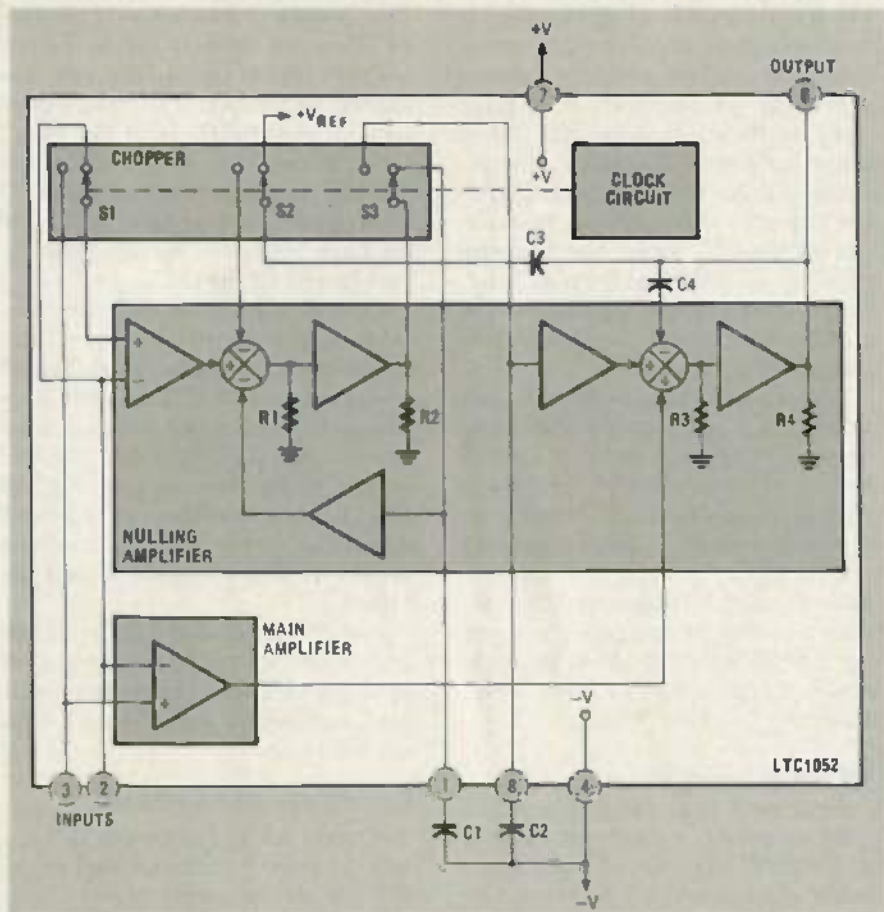

FIG. 1

WHEN YOU NEED AN OP-AMP THAT HAS low input-bias current, extremely low input-offset voltage, excellent long-term stability, and a good temperature coefficient, two new devices to be considered are the LTC1052 and the LTC7652 chopper-stabilized op-amps from Linear Technology Corporation. The chopper-stabilization scheme constantly monitors and corrects offset-voltage errors that develop over time, along with errors due to variations in temperature and

common-mode voltage. That error correction, coupled with input currents in the picoampere range, gives those devices exemplary performance and makes them worthy of use in many applications of consideration.

The LTC1052 and the LTC7652, sometimes called "discrete-time" or "sampled-data" amplifiers, are available in the metal can "H" package, and in 8- and 14-pin hermetic and plastic DIP's. In various packaging configurations, the op-

amps are direct replacements for similar devices from Intersil.

Both op-amps feature a maximum offset voltage of five μV and a maximum offset drift of 0.05 $\mu\text{V}/^\circ\text{C}$. In addition, maximum input bias current is 30 pA. Other specifications include: minimum gain of 120 dB; minimum CMRR of 120 dB; and minimum PSRR of 120 dB. Either op-amp can be operated from a single-ended power supply (maximum of 18 volts); and both are rated to operate over the -40 to $+85^\circ\text{C}$ range.

Chopper stabilization works like this. As shown in Fig. 1, the main amplifier is connected at all times between the input and the output of a circuit. A nulling amplifier, controlled by a chopping-frequency oscillator and a clock circuit, is cross-connected to the main amplifier circuit—input to output and output to input. The chopper can be thought of as several ganged switches (S1-S3), and the amplifiers as transconductance amplifiers. Two external capacitors (C1-C2) function as sample-and-hold circuits; the value of each capacitor normally ranges from 0.1 to 1.0 μF .

The null amp alternately nulls itself and the main amplifier. During half of the clock cycle (the auto-zero phase), the null amplifier inputs are shorted and a voltage equal to the amplifiers's offset voltage is stored on capacitor C1. During the following half-cycle of the clock (the sampling phase), the main amplifier's inverting and non-inverting inputs are compared and a voltage equal to the input-offset voltage is stored on capacitor C2. In other words, the

two capacitors store the potentials needed to null the offset voltages of both the null and the main amplifiers. The nulling scheme operates over the full common-mode and supply-voltage ranges, so CMRR, PSRR, and large-signal voltage gain are extremely high. A constant DC voltage for nulling the input offset is produced by switching between the sampling and the nulling phases at a frequency much lower than the frequency of the input signal.

When the null amplifier inputs are shorted together during the auto-zero cycle, they are also connected to the main op-amp's inverting input. Hence, nulling the input-offset voltage while common-mode voltage is present results in an extremely high CMRR. Power supply variations are nulled in a similar manner, and that's what gives the excellent PSRR mentioned above.

During the sampling cycle, the output of the first stage of the main amplifier is summed with the sampling circuit signal and then applied to the input of the second stage of the main amplifier. As the frequency of the input signal increases, error signals develop as the result of heterodyning (mixing of the input signal and the sampling signal). That produces error signals at a frequency f_e equal to the sum of or the difference between the sampling frequency, f_s , and the input frequency, f_i .

$$f_e = f_s \pm f_i$$

The *summed* error signal is of little concern because it is a high frequency that can be filtered out easily. However, when the input frequency approaches the sampling frequency (typically 330 Hz) the *difference* frequency approaches zero and that can cause DC errors—the problem that a chopper-stabilized amplifier is supposed to eliminate.

The solution is to filter the input to the sampling loop so that the circuit never sees any frequency that is near the sampling frequency. At a frequency well below the sampling frequency, the circuit forces the current out of the first stage of the null amplifier to equal the current through C_1 . The difference between them is zero, so

the gain of the sampling loop is zero at that frequency, and at higher ones. Hence we have a low-pass filter whose cutoff frequency is determined by components in the output stage.

Each op-amp has a separate high-frequency amplifier; the -3-dB turnover frequencies for both the DC and the high-frequency paths are identical and equal. Therefore overall frequency response is smooth and free from sampling noise.

Practical considerations

Circuit-board layout and the choice of external components both require careful consideration if low offset drift and bias current are to be maintained. A 20-page data application note has three pages of detailed applications information for the LTC1052/LTC7652. Included is information that explains how to avoid the harmful effects of thermoelectric junctions, temperature transients, circuit-board leakage, and leakage in the holding capacitors.

Also included are eighteen practical circuit applications including a precision instrumentation amplifier, a thermocouple amplifier with cold-junction compensation, a thermocouple-to-frequency converter, a 16-bit A-D converter and a voltage-to-frequency converter. A copy of the data sheet can be obtained from Linear Technology Corp., 1630 McCarthy Blvd., Milpitas, CA 95035-7487.

Precision op-amps

Four new high-reliability precision op-amps, processed to MIL-STD-883B specifications, have been announced by Solitron Devices. They feature high speed, low noise, low offset voltage and low drift. The OP-01 is a high-speed op-amp that features an 18 volt/ μ s slew rate, and a 0.7 μ s switching time. The OP-07 is an ultra-low-offset-voltage op-amp that features 10 μ v offset voltage, and drift of only 0.2 μ v/ $^{\circ}$ C. The OP-01 is available in a dual version (the OP-201), as is the OP-07 (the OP-207). The OP-01 and OP-07 conform to 741 pin-outs.

The op-amps are available in a variety of packages, including chip carriers. Military versions are avail-

able in hermetic metal cans as well as ceramic mini-DIP's and chip carriers. Commercial version are priced from \$1.39 in quantities less than 1000; military versions start at \$5.25 in the same quantities. Complete information and specifications from Solitron Devices, Sales Dept., 1177 Blue Heron Blvd., Riviera Beach, FL 33404.

Low on-resistance transistors

The 2N7010 and 2N7011 FETlington devices (recently JEDEC-registered by Siliconix) offer greatly reduced on-resistance and increased power dissipation. The newest members of the FETlington family of low-cost MOSPOWER products are designed to replace Darlington configurations with one compact DMOS device. The miniature TO-237 package offers a low-cost alternative to the larger TO-220 package, without changing the circuit-board design.

On-resistance of the new devices is 0.35 ohm and they have breakdown voltages of 60 and 40 volts, respectively. They can handle continuous drain current of 1.3 amps. Maximum continuous power dissipation is one watt in free air, but dissipation doubles when the device is soldered to a conventional printed-circuit board.

The 2N7010 and 2N7011 are \$1.00 and \$0.92 each, respectively, in 1000-piece lots.—Siliconix, Inc., 2201 Larelwood Rd., Santa Clara, CA 95054.

Circuit design handbook

Circuit Ideas For Linear IC's is a new 34-page handbook that offers 102 practical circuits using linear IC's and MOSFET's. Each circuit uses one or more of each type of device.

The handbook is divided into nine sections of industrial and consumer applications. Among them are sections on timing, measurement, modulation, power control, data conversion, communications, and alarm/monitoring. Several indexes are provided.

A full schematic of each circuit idea is shown along with a brief circuit description. For a free copy write to RCA Solid State, P.O. Box 2900, Somerville, NJ 08876. R-E

COMMUNICATIONS CORNER

Spikes and cures

COMPUTER CIRCUITS OFTEN ENHANCE communications systems, but they also create new problems of their own. Chief among those problems is susceptibility to transient voltage surges, or what we generally call spikes.

Unlike vacuum tubes, solid-state devices are extremely sensitive to the transient voltage surges that appear on power and signal lines. Unless it is directly struck by lightning, communications gear built from tubes is seldom disturbed by a surge, whether it's picked up by the power lines, the telephone lines, or even an antenna. A lightning arrester usually provides tube gear with sufficient protection from lightning strikes.

But solid-state equipment is another story. A TV set, a CB radio, a ham rig, a commercial VHF transceiver—everyone knows that just one surge can wipe out data memory or stored programming; a particularly bad surge could even destroy the device as a whole. For example, a lightning strike hundreds of feet away could cause a surge in the power lines strong enough to zap a solid-state power supply, or a lightning strike in the next county, or the start-up of an oil burner—which can generate a spike of almost 2000 volts—could cause a glitch in a computerized receiver, transmitter, or control center.

Whether it appears on the power lines, the telephone wires, an antenna, or the electrical system of a motor vehicle, a transient spike can be very dangerous. Because of its shape, a spike contains a great deal of high-frequency en-

ergy—which can flow through or around filters from one circuit to another—as well as a high-voltage component. The high-frequency energy could disturb data memory or modify programming, and the high voltage could destroy solid-state components.

Figure 1 shows how transient

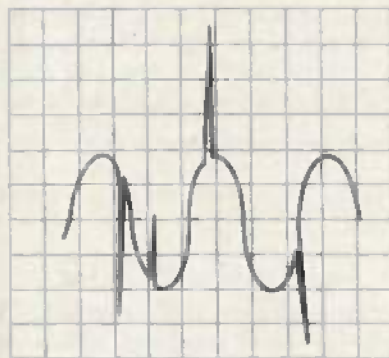

FIG. 1

spikes on the AC power line might appear. The voltage at any instant in time depends on which part of the AC cycle the spike is superimposed on, as well as the direction of the spike. For example, a positive-going spike that occurs at the positive crest of the waveform results in a transient that is the sum of the two signals. Since the spike could range from several hundred to several thousand volts, depending on what generated it, the peak instantaneous voltage could exceed the peak voltage rating of a solid state device easily.

What makes a spike so insidious is that it lasts for a very short period of time and that it is composed of signals that are often too high to be safely bypassed by a circuit's normal "interference filter." Also, those high-frequency

signals can be capacitively coupled from wire to wire and circuit to circuit because, at high frequencies, a small amount of capacitance provides a low-impedance path for whatever happens to come along.

Spike remedies

A spike is usually best dealt with by a device generically known as a "surge suppressor." A surge suppressor may be built from a bi-directional Zener diode, or more commonly, from one or more MOV's (Metal-Oxide Varistors).

A bi-directional Zener simply clips any spike that exceeds a predetermined value, usually 150 to 180 volts. They're effective, but they can't dissipate much power, so if the transient lasts for more than a few microseconds the heat that is generated can destroy the diode.

An MOV, on the other hand, is a resistor whose value decreases sharply when the applied voltage exceeds a predetermined level. MOV's used on AC power lines commonly trip at 150 to 180 volts. Although the MOV does not respond to spikes quite as fast as the Zener diode, it can dissipate more power than a bi-directional Zener. Since MOV's are reliable and inexpensive, they are used in a broad range of suppression devices intended for both power and telephone lines. A MOV can be connected directly across the power line, as shown in Fig. 2-a, or from each side to ground, as shown in Fig. 2-b.

Modern modems and digital telephones usually have a MOV wired between ground and the



HERB FRIEDMAN,
COMMUNICATIONS EDITOR

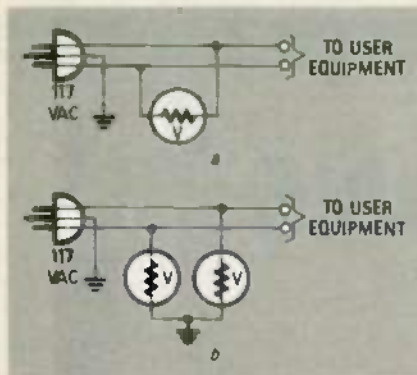

FIG. 2

point where the device connects to the telephone line; that helps prevent transient disturbances generated in the telephone network from entering the sensitive equipment and wreaking all sorts of havoc. Generally, the MOV is connected to the user's side of the ring detector so that the 90-volt ringing signal doesn't affect the MOV. That's done because the MOV is generally rated at 25 to 50 volts in order to protect the signal circuit, which usually operates at a loop voltage of 5- to 10-volts DC.

Power-line interference

Telephone equipment has problems with spikes, but AC power lines have even more problems due to interference from sources other than transient spikes. For example, low-frequency RF interference that cannot be suppressed with a spike suppressor is generated when the electric utility

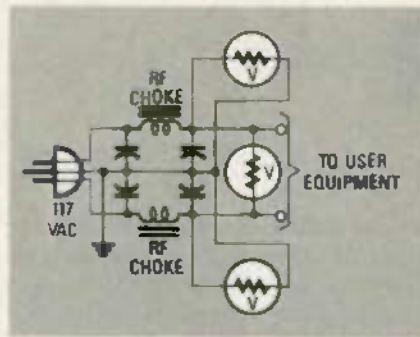

FIG. 3

switches a capacitor on or off the power line to maintain the power factor. Further, a ham or CB transmitter can radiate substantial amounts of RF into the power line.

As a general rule, when a piece of equipment is subject to both transient spikes and RF inter-

ference, we use a device that has both transient surge suppression and RF filtering, like the "power line filter" shown in Fig. 3. The MOV's handle the spikes while the RF chokes prevent RF from passing either in to or out of that piece of equipment.

Although much modern communications equipment contains filtering for the types of interference we've been discussing, much older gear was manufactured before the effects of transients and RF hash.

There's no guarantee that filtering of that sort will solve your problems, however. The reason is that transient interference may not be the cause! Verifying the presence of spikes and other interference can be quite difficult because signals like those are often brief.

So, if you have no good ideas about what might be causing seemingly random malfunctions of digital equipment, or if you just want to play it safe, adding a surge/RF suppressor to your equipment may be a good idea. **R-E**

SERVICE QUESTIONS

continued from page 76

INTERMITTENT BRIGHTNESS

Recently the brightness on an RCA CTC92C became erratic. Voltage measurements indicated that the trouble was in the red section of the kine driver module. After replacing Q4, the red bias transistor and C4 (a 4.7 μ F electrolytic), the problem cleared up. But, when the parts that I'd removed were checked using an ohmmeter, they tested good. Can you shed a little light on what's happening?—J.N., Dalton IL

I have a feeling that you have not done a thorough job in checking. Component failure in the red-driver circuit shows up as changes in the red gun *only*, and not as a brightness problem.

If the trouble returns (and I don't doubt that it will), look to the luminance section. Something in that section must be malfunctioning, causing a rise and fall in the voltage entering pin 4 of the driver module. That voltage sets the bias of all three outputs, and is also

responsible for the brightness level.

SHUTDOWN PROBLEM

The Panasonic NMX-P3A chassis that I've been working on has an overload in the video section, which causes the set to shut down at turn-on. I thought that IC102 was bad. But after changing that IC, I had no picture at all. When the original was placed back in the set, the overload condition returned. Could the replacement have been bad?—P.S., E. Northport, NY

Welcome to the club: You've just experienced one of the worst things that can happen to a repairman—changing a part, only to wind up with a worse problem than you began with. Yes, it is within reason to suspect that the replacement part was defective, but there is always the possibility that you missed a solder joint.

Nevertheless, I agree with your original diagnosis. I've seen IC102 cause the condition that you described. Bear in mind, however, that IC101 contains all the AGC circuits, so look to it as the next most

likely trouble spot. But, before anything else, check the AGC controls with an ohmmeter.

CAN'T TUNE CHANNEL 13

I can't get Channel 13 to come in on an Admiral TV (chassis number 28M55) with touch tuning. After sending the tuner out for repairs, I was able to get Channel 13 for about 2 weeks and then it quit again. Can you help me?—B.T., Delta, IA

You are dealing with a varactor tuner, which uses different voltages to tune each channel—the one for 13 being 3 volts higher than the Channel 11 voltage. You stated that you cannot get Channel 13 in any position. Well that eliminates the selector switch and the number 13 potentiometer as possible trouble spots.

If you can't get 20.8 volts on the potentiometer wiper arm, then perhaps the 33-volt supply that feeds all the potentiometers is low. If the voltage is correct, I would talk to my tuner repairman to find out what voltage he's using to pull in Channel 13 (which is obviously not being supplied). **R-E**

DESIGNER'S NOTEBOOK



ROBERT GROSSBLATT,
CIRCUITS EDITOR

An audio oscillator

AT VARIOUS TIMES I'VE PRESENTED YOU with several handy-dandy oscillator circuits of one kind or another. But if you're into building your own equipment you know the truth of Grossblatt's fifteenth law: *You can never have too many oscillators.*

An oscillator can be built from just about anything ranging from a handful of transistors to a rusty door hinge, but one circuit usually works better in a particular application than others. Some oscillators produce nice clean logic-level pulses; others are better suited for generating audio tones, etc. While reviewing past installments of this column, I realized that I've never shown you an oscillator that will drive an eight-ohm speaker. This month's circuit will correct that deficiency.

An audible tone generator is a useful circuit to have in the back of your drawer. It could be used as an alarm, a microphone tester, or any of a bunch of other things. For example, if you've ever done any recording that uses more than three or four microphones, you know how much trouble it is to keep the cables straight and to set uniform levels on the mixer. By attaching a battery-operated beeper to a microphone with a rubber band, the task will be much easier.

The oscillator shown in Fig. 1 is built around the popular and easily-obtainable LM386 low-voltage audio amplifier. Even Radio Shack carries it as one of their ever-dwindling stock of IC's. As you can see, the circuit requires only a handful of parts. The LM386 is such an even-tempered IC that it doesn't really care how you put those parts

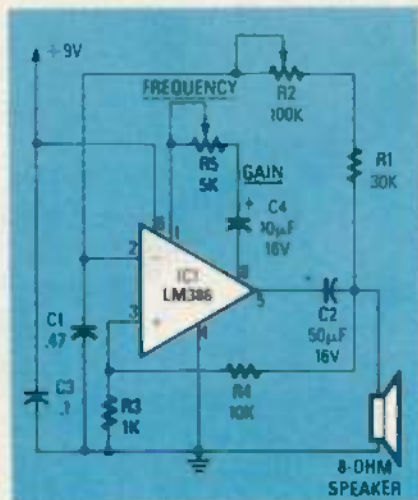

FIG. 1

together. You could design a PC board to hold the parts, but the circuit will work just as well with wire-wrap construction.

The circuit's frequency of oscillation can be calculated easily from this formula: $f = 2.8 / [C1 \times (R1 + R2)]$. If you use the values I've indicated, you'll be able to vary the output from 60 Hz to 20 kHz by rotating potentiometer R2. There will be some droop in output at either end of R2's rotation, but, for microphone testing, that's not a problem.

How it works

A portion of IC1's output voltage is fed to its non-inverting input (pin 3). That voltage serves as a reference for capacitor C1, which is connected to the non-inverting input (pin 2) of the IC. That capacitor continually charges and discharges around the reference voltage, and the result is a squarewave output. Capacitor C2 decouples the output so you get a nice AC

signal to drive the speaker.

With GAIN control R5 at maximum, the circuit will deliver a fairly loud signal—about 40 dB according to my sound level meter. The LM386 has a 1350Ω resistor connected internally between pins 1 and 8. That resistor limits the minimum gain of the IC to about 20 dB. The 10-µF capacitor, C4, bypasses the resistor and allows you to vary the gain with an external control. If you don't need a gain control, just short pins 1 and 8 together.

Varying the size of output decoupling capacitor C2 also affects overall circuit gain. To change gain, you could experiment with its value, but you'll find that using a potentiometer and a capacitor across pin 8 is the easiest way to alter gain.

As with all circuits presented in this column, you can use them just as they appear here, but chances are that they'll be a lot more useful to you if you experiment with them to meet the needs of your specific application. R-E



Learn the IBM PC's secrets with the
MICROPROFESSOR 1/88



Students, engineers, or technicians—
Now you can learn micro-processing and
understand the technology which made
the IBM PC famous.

The MPF-1/88 features:

- extensive documentation
- 16-bit central processor
- full-size keyboard
- special options

Three tutorial guides cover all capabilities.
The ideal training tool! If the IBM PC or
micro-processing are in your future, you owe
yourself an MPF-1/88. Invest now!

Only \$349.95

Plus—

- Check this box for a FREE
MPF-1/88 tutorial textbook
when you order within 7
days. \$34.95 value.

ETRONIX
Dept. RE0886
3326 9th Ave. NE
Seattle, WA 98105-3617

For immediate action call TOLL FREE:

1-800-426-1044

Full money back
guarantee.

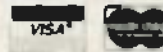

CIRCLE 177 ON FREE INFORMATION CARD

Cash in on the Video-Cassette Boom!
**START YOUR OWN TV/VCR
REPAIR BUSINESS**
of Home In Spare Time



Now it's easy for you to
get into this money-
making business. Be the
person in demand by the
millions of families who
own videocassette record-
ers—the fastest-growing product in
the home entertainment field.

Train at home in your spare time for an exciting
career as a TV/VCR Repair Specialist. Experts
show you how to start small at home with low
overhead. Later you can go after repair business
from hotels, offices, hospitals and other
companies who use TVs and VCRs in their
daily operations.

Experts show you what to do, how to
do it...guide you every step of the way!

Learn how to handle house calls and shop re-
pairs—everything you need to know to get start-
ed fast. Tools are included with your course so
you get "hands-on" practice as you follow your
lessons step by step. Everything is explained in
easy-to-understand language, but if there is ever
anything in your lessons you don't understand,
you can write or phone your instructor and you
can count on getting an authoritative answer.
Get free facts and color brochure that tell about
home business opportunities. No cost. No
obligation. No salesman will visit.

MAIL COUPON TODAY!

SCHOOL OF TV/VCR REPAIR, Dept. DE076
Scranton, Pennsylvania 18515

Please send me free facts on how I can learn
TV/VCR Repair at home in my spare time.

Name _____ Age _____

Address _____

City/State/Zip _____

Phone () _____

POWER SWITCH

continued from page 46

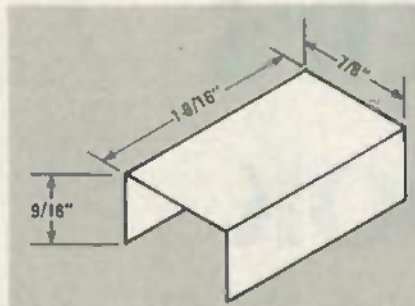

FIG. 7—CUT AND BEND THE UPPER SHIELD
from a thin piece of tin as shown here.

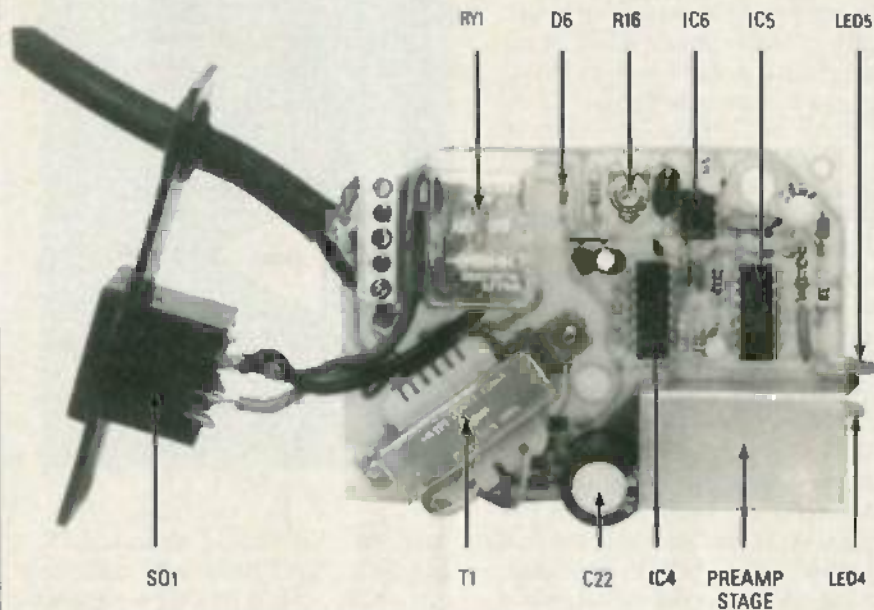

FIG. 8—THE RECEIVER'S PC BOARD should appear as shown here after all components have
been mounted.

tal. Then fit the panel over the two LED's
so that the legs of the filter fit around the
photodiode. Insert the panel-board as-
sembly into the bottom half of the receiver
case.

Testing and alignment

Plug the receiver into an AC outlet. The
SIGNAL LED should light briefly and then
go out, and the ON LED should remain
off. Set trimmer potentiometer R16 to the
center of its range.

Now aim the transmitter at the pho-
todiode and press S1. With a little luck,
the center frequency of the 567 will be
close enough to the transmitter's output
frequency that the SIGNAL LED will light
up temporarily. The ON LED should light
up and stay lit, and the relay should latch
on. A second press of the button will turn
the LED and the relay off—that is, of
course, only if you're lucky.

If the receiver doesn't respond, adjust
R16 slightly and try again. Repeat that

until you get some response from the cir-
cuit. Don't worry about making an exact
adjustment. The adjustment we're doing
now is preliminary; the receiver must be
fine-tuned to obtain maximum range of
about 30 feet.

After you get a response, solder the
shields in place. The easiest way to do that
is to melt a small amount of solder in each
corner of the shield. Then set the shield in
place and heat each corner in turn to let
the solder flow onto the pin.

To fine-tune the receiver, set it up in a
position where you can get a clear line of
sight to it for a distance of about 30 feet.
Position yourself about five feet from the
receiver, point the transmitter at the re-
ceiver, and press the TRANSMIT button.

If the receiver responds, back up an-
other five feet and try again. Remember to
let the transmitter recharge for a few sec-
onds between transmissions, particularly
when you're standing back at distances of
ten feet or more.

Continue backing up in five-foot seg-
ments until you reach a point where the
receiver will not respond. At that point,
adjust R8 slightly and try again. An as-
sistant to handle the transmitter would be
helpful.

Even under worst-case conditions, the
receiver should be able to respond when
the transmitter is 20 feet away. If you can
adjust it to respond to signals only up to a
certain distance but no farther, your prob-
lem is likely due to overly bright lighting,
electrical or RF noise, or something else.
Don't blame the receiver!

Assemble the case and plug the device
you want to control in. You're now free to
operate that device at your convenience,
free from the tyranny of its switch! R-E

COMPACT DISCS

continued from page 63

merging bits per frame.

Using EFM, the 338-bit words become 33 14-bit words (462 bits) plus three bits each for merging bits (99 bits), plus another 27 bits for the synchronization word and its merging bits. And there, finally, is our total: $462 + 99 + 27 = 588$.

Dividing It Up

With the numbers now at hand, let's examine the percentages once again. We can do that by comparing the number of bits used for each purpose in a frame with the total number of bits—588—in that frame.

What we're most interested in is the audio information on the disc. Not surprisingly, after all we've been through, we find that all the bits used in a frame for audio—192 of them—account for only 32.7% of its information content. See Fig. 4. That's all there is; everything else is there to make sure that the music comes

service (November and December 1985, and the January through March 1986 issues). We have prepared a special reprint of the series, called *Repairing Compact Disc Players*. It's available from the **Radio-Electronics Reprint Bookstore**, 500-B Bi-County Blvd., Farmingdale, NY 11735 for \$5.00 plus \$1.00 shipping.

Postscript

There are still a few bits we haven't looked at at all yet. They're the R through W bits of the subcode, six bits that aren't used for anything at all on an audio disc. Why are they there?

When the standard used to record information on CD's was devised, some forethought was given to future needs. The R-W subcode bits were included so that the disc could be used for storing things other than audio.

Those 200 million or so bits worth of unused space can hold about 20 megabytes of data, as much as the standard hard disc drive in an IBM PC/AT. At 2000 characters per page, that's 10,000 pages of text, or about 1250 articles as long as this one—with music to read them by.

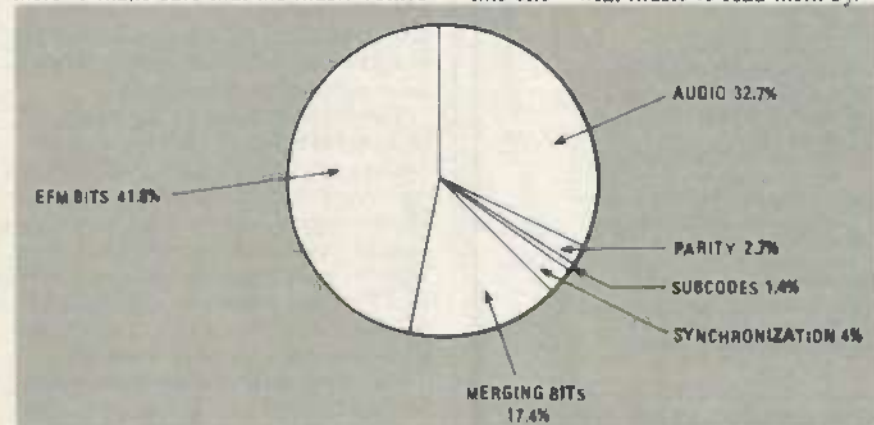

FIG. 4—THIS CHART shows the relative sizes of the subgroups that make up a frame of CD information. Note that the relationship between the "housekeeping" bits and the audio information is roughly 2:1.

through to you as easily—and sounding as good—as it can.

The 64 bits of parity information make up about 2.7% of the total, and the synchronization bits account for just over 4%. The 102 merging bits take up 17.4% of the space in a frame and, finally, the 8 subcode bits occupy a little under 1.4%.

Of course, that only adds up to 58.2%! What we are forgetting about again is EFM. Expanding the 8-bit words to 14 bits accounts for the missing 41.8%. On the surface that seems inefficient, but overall it works out for the best.

In the end, it takes a total of 588 bits of information to represent 192 bits of audio. That's more than a ratio of 2:1 for the overhead, which may at first seem wasteful. But once you've listened to a compact disc, you'll agree that it's worth it.

For the theory behind CD player operation, you may want to read the 5-part **Radio-Electronics** series about CD player

Many CD players are already equipped with a subcode output that could easily be connected to a decoder to present such things as the historical background of a piece of music, or an analysis of the score, while the music was playing.

That same subcode space on a compact disc could also be used to store some 700 digitized still video images; a new one could be displayed every five seconds. We could have still-music-video CD's, or, on a higher plane, show the actual score of the piece being played, or scenes—not graphics, but real video pictures—from operas or Broadway musicals.

And that's how all those "millions and millions" of bits on a CD are used. It may be disappointing to find out that so little of the available space actually stores audio, but it's reassuring to know that just about all the rest of what's on the disc is there to ensure that you hear music that is reproduced as faithfully as possible. **R-E**

RADAR CONTROLLER

continued from page 42

Once you've etched or purchased the board, mount the components on the board as shown in the parts-placement diagram, Fig. 7. Be sure that all components are oriented as shown. Bolt the regulator and power the transistor to the circuit board for heat sinking.

The Gunn diode, which is mounted in a microwave horn, draws up to 1 amp of current, so use number 18 wire for the connection between the circuit and the horn, and keep the length to 10 feet or less. *Under no circumstances* should you connect DC voltage to the Gunn diode or reverse the polarity of the connections to the diode (power is fed to the anode side; the cathode side is grounded). Doing either will almost certainly blow out that \$60.00 component.

When mounting the microwave horn, be sure that metal objects are kept away from the opening (plastic will do no harm). The power supply for the unit should be able to supply 12-volts DC at 2 amps; most automotive electrical systems are capable of meeting that requirement.

After construction and hook-up, test the unit by aiming it toward an automotive radar detector and depressing the TRANSMIT switch. That should cause LED2 to light. Also, the radar detector should react as appropriate (a buzzer should sound or an LED should flash) to the presence of a radar signal. Verify the oscillating frequency of the 555 timer by connecting a scope or frequency counter to pin 3 of that IC. With the S3 set to 55, the frequency measured should be 39,600 Hz.

Warnings

While the radar calibrator can be a useful diagnostic tool in aligning radar speed-guns, if used for illegal purposes and/or by unlicensed individuals, it can be the cause of a great deal of trouble. (Penalties of up to \$10,000 and a year in jail are some of the possible consequences of such use.) Further, because of possible interference to police radar, communications services, etc., the unit should only be used in a laboratory, and only for educational or calibration purposes.

It may be possible for certain individuals, such as licensed amateur-radio operators, to use the calibrator legally in the workshop, the laboratory, or the field, but it is left to the individual user to ascertain the requirements for such use, and to meet them.

In any event, any willful interference to another service by any individual is punishable with stiff penalties under Federal law; other local, state, or Federal penalties may also be applicable. We strongly discourage use for such applications. **R-E**

TV SIGNAL DESCRAMBLING

continued from page 53

works. Encoded video is applied to pin 14 of the LM733, while a suitable decoding signal is applied to pin 1. Note that both of those signals are capacitively coupled into the LM733 so that they do not interfere with the biasing of that device. The output of the LM733, at pin 8, is a signal that is proportional to the difference of the two inputs. An inverted version of the signal at pin 8 is available at pin 7. Having both

signals can come in handy, particularly when a signal that inverts intermittently must be decoded; such a signal occurs when video is encoded using the SSAVI system. The two outputs can be fed to an electronic switch that is used to select the signal with the proper polarity.

Either of the two variable-gain circuits can be used as a video or RF modulator. While such variable-gain circuits are obviously more complex than the attenuator circuits previously discussed, they are also more linear and easier to control. That is particularly important when dealing with sinewave-encoded signals.

Restoring the sync pulse

When the sync signal is suppressed (or missing entirely) the sync pulses must be generated at the receiver. Naturally, those pulses should be identical to the sync pulses that were originally present in the video signal. That means that the recreated sync signal must have the proper phase and that the pulses must have the proper amplitude and width.

In the simplest cases, the original sync signal is merely reduced in amplitude. For those, all that needs to be done is to increase the amplitude of the sync pulses with respect to the video information.

Other times, the sync has been completely removed. If that has been done, the receiving circuitry must reconstruct the missing pulses using information that is "hidden" elsewhere.

Let's look at two circuits that can be used for reconstructing missing sync pulses. The circuit in Fig. 8 is for systems that have a 15.75-kHz subcarrier encoded within the audio channel.

The heart of the circuit is IC1, an LM1310 PLL FM-stereo demodulator. While that IC was designed for 19-kHz FM-stereo pilot-carrier regeneration, when configured as shown it can be made to operate at 15.75 kHz. (The operating frequency is adjusted using R6.)

The output from the TV set's audio detector is fed to pin 2 of IC1 via an emitter follower and a filter circuit. A 15.75-kHz squarewave output appears at the pilot monitor output, pin 10. Note that if the program audio has been stripped away from the main audio channel and placed on a 31.5-kHz subcarrier as discussed in the first part of this series, the program audio is available at pin 4 of the PLL.

The pilot-monitor output is too wide to be used directly as a gating pulse. Because of that, it is next fed to IC2, a CD4098BC dual monostable multivibrator. One half of the IC is used to delay the pulse so that the sync signal is "in phase" with the encoded video signal. The output of that half of the IC is used to trigger the second half. The second half of the IC is used to set the proper pulse width. The output of that half of the IC is the reconstructed sync signal. Note that both positive and negative going outputs are available.

If the sync signal is missing, and there is no encoded 15.75-kHz signal available in the audio, a circuit like the one in Fig. 9 can be used. The heart of the circuit is an MM5320/MM5321 video-camera sync generator. That device needs only a 2.0457-MHz clock signal to recreate all the components of an NTSC sync signal. The needed clock signal can be derived from the video signal's 3.58-MHz colorburst signal as shown.

Next time we'll look more closely at using PLL's to extract decoding subcarriers from the video signal. R-E

Radio-Electronics REPRINT BOOKSTORE

- | | | | |
|---|---------|---|--------|
| <input type="checkbox"/> 150 TV Descrambler (Jan., Feb. 1981) | \$3.00 | <input type="checkbox"/> 111 Hands On Electronics #1 | \$4.50 |
| <input type="checkbox"/> 151 Build Your Own Robot | \$12.00 | <input type="checkbox"/> 112 Hands On Electronics #2 | \$4.50 |
| <input type="checkbox"/> 152 8-Ball Satellite TV Antenna | \$5.00 | <input type="checkbox"/> 113 Hands On Electronics #3 | \$4.00 |
| <input type="checkbox"/> 106 Radio-Electronics back issues (1986) | \$3.00 | <input type="checkbox"/> 114 Hands On Electronics #4 | \$4.00 |
| Write in issues desired | | <input type="checkbox"/> 115 Hands On Electronics #5 | \$4.00 |
| <input type="checkbox"/> 105 Radio-Electronics back issues (1985) | \$3.50 | <input type="checkbox"/> 115A Hands On Electronics #6 | \$3.50 |
| Write in issues desired | | <input type="checkbox"/> 116A Hands On Electronics (Jan-Feb '86) | \$3.50 |
| <input type="checkbox"/> 104 Radio-Electronics back issues (1984) | \$4.00 | <input type="checkbox"/> 154 VCR Repairs | \$3.00 |
| (Feb., Dec. 1984 not available) | | <input type="checkbox"/> 155 IBM Typewriter to Computer Interface | \$3.00 |
| Write in issues desired | | <input type="checkbox"/> 125 Radio-Electronics Annual 1985 | \$3.50 |
| <input type="checkbox"/> 103 Radio-Electronics back issues (1983) | \$4.00 | <input type="checkbox"/> 126 Radio-Electronics Annual 1986 | \$2.50 |
| (Jan., Feb., May 1983 not available) | | <input type="checkbox"/> 156 How to Make PC Boards | \$2.00 |
| Write in issues desired | | <input type="checkbox"/> 157 All About Kits | \$2.00 |
| <input type="checkbox"/> 102 Radio-Electronics back issues (1982) | \$4.00 | <input type="checkbox"/> 158 Electro Importing Co. Catalog (1918) (176 pp) | \$5.95 |
| (Jan., Feb., June 1982 not available) | | <input type="checkbox"/> 159 Low Frequency Receiving Techniques Building and using VLF Antennas | \$6.00 |
| Write in issues desired | | <input type="checkbox"/> 160 New Ideas - 42 circuits for experimenters | \$3.50 |
| <input type="checkbox"/> 101 Radio-Electronics back issues (1981) | \$4.00 | <input type="checkbox"/> 161 Descrambling (Feb., 1984) | \$2.00 |
| (Jan., Feb., Mar., May, Nov., Dec. 1981 not available) | | <input type="checkbox"/> 162 Build Your Own Satellite TV Receiver | \$7.00 |
| Write in issues desired | | <input type="checkbox"/> 163 Receiving Satellite TV | \$7.00 |
| <input type="checkbox"/> 153 Etch your own PC boards | \$3.00 | <input type="checkbox"/> 164 Modern Electrics (April 1908) | \$3.00 |

To order any of the items indicated above, check off the ones you want. Complete the order form below. Include your payment, check or money order (DO NOT SEND CASH), and mail to Radio-Electronics, Reprint Department, 500-B Bi-County Boulevard, Farmingdale, NY 11735. Please allow 4-6 weeks for delivery.

If you need a copy of an article that is in an issue we indicate in unavailable you can order it directly from us. We charge 50¢ per page. Indicate the issue (month & year), pages and article desired. Include payment in full, plus shipping and handling charge. Make checks payable to Gernsback Publications, Inc.

ARTICLE

PAGES	MONTH	YEAR
TOTAL PAGES	@ 50¢ each	TOTAL PRICE

MAIL TO: Radio-Electronics

Reprint Bookstore, 500-B Bi-County Boulevard, Farmingdale, NY 11735 All payments must be in U.S. funds

SHIPPING CHARGES IN USA & CANADA

\$0.01 to \$5.00	\$1.00	\$30.01 to 40.00	\$4.75
\$5.01 to \$10.00	\$1.75	\$40.01 to 50.00	\$5.75
\$10.01 to 20.00	\$2.75	\$50.01 and above	\$7.00
\$20.01 to 30.00	\$3.75		

OUTSIDE USA & CANADA

Multiply Shipping by 2 for sea mail
Multiply Shipping by 4 for air mail

Total price of merchandise

Sales Tax (New York State Residents only)

Shipping (see chart)

Name

Total Enclosed

Address

City

State

Zip

RB8-6

MARKET CENTER

SATELLITE TV

CABLE TV SECRETS—the outlaw publication the cable companies tried to ban. HBO, Movie Channel, Showtime, descramblers, converters, etc. Suppliers list included. \$8.95. **CABLE FACTS**, Box 711-R, Pataskala, Ohio 43062.

SATELLITE Descrambler Schematics; Oak Orion PD-400C \$20.00; VideoCipherII \$20.00; VideoCipherII Patent \$15.00; actual VideoCipherII descrambler \$550.00; actual Oak Sigma descrambler \$350; Catalog \$5.00; send money order to **ELECTRONIC PRESS**, PO Box 10009, Colorado Springs, CO 80932.

CLOSED circuit feed! You can watch your favorite TV shows days in advance when you know where to look. Send \$5.00 to **DOWNLINK**, 9420 Reseda Blvd., #473R, Northridge, CA 91324.

BUILD your own satellite system and save! Instructions, schematics, parts! Send stamped envelope: **XANDI**, Box 25647, Dept. 21D, Tempe, AZ 85282.

CABLE TV Source Book—a complete listing of suppliers for hard-to-find converters, descramblers, technical information, schematics and much much more. Full refund if not satisfied. Send \$4.95 to **CABLE**, Box 12505-R, Columbus, OH 43212.

CLASSIFIED AD ORDER FORM

To run your own classified ad, put one word on each of the lines below and send this form along with your check to:

Radio-Electronics Classified Ads, 500-B Bi-County Boulevard, Farmingdale, NY 11735

PLEASE INDICATE in which category of classified advertising you wish your ad to appear. For special headings, there is a surcharge of \$23.00.

() Plans/Kits () Business Opportunities () For Sale
() Education/Instruction () Wanted () Satellite Television

Special Category, \$23.00

PLEASE PRINT EACH WORD SEPARATELY, IN BLOCK LETTERS.

(No refunds or credits for typesetting errors can be made unless you clearly print or type your copy.) Rates indicated are for standard style classified ads only. See below for additional charges for special ads. **Minimum: 15 words.**

1	2	3	4	5
6	7	8	9	10
11	12	13	14	15 (\$42.75)
16 (\$45.60)	17 (\$48.45)	18 (\$51.30)	19 (\$54.15)	20 (\$57.00)
21 (\$59.85)	22 (\$62.70)	23 (\$65.55)	24 (\$68.40)	25 (\$71.25)
26 (\$74.10)	27 (\$76.95)	28 (\$79.80)	29 (\$82.65)	30 (\$85.50)
31 (\$88.35)	32 (\$91.10)	33 (\$94.05)	34 (\$96.90)	35 (\$99.75)

We accept MasterCard and Visa for payment of orders. If you wish to use your credit card to pay for your ad fill in the following additional information (Sorry, no telephone orders can be accepted.):

Card Number

Expiration Date

Please Print Name

Signature

IF YOU USE A BOX NUMBER YOU MUST INCLUDE YOUR PERMANENT ADDRESS AND PHONE NUMBER FOR OUR FILES. ADS SUBMITTED WITHOUT THIS INFORMATION WILL NOT BE ACCEPTED.

CLASSIFIED COMMERCIAL RATE: (for firms or individuals offering commercial products or services) \$2.85 per word prepaid (no charge for zip code)...**MINIMUM 15 WORDS**. 5% discount for same ad in 6 issues; 10% discount for same ad in 12 issues within one year, if prepaid. **NON-COMMERCIAL RATE:** (for individuals who want to buy or sell a personal item) \$2.30 per word, prepaid...no minimum. **ONLY FIRST WORD AND NAME** set in bold caps at no extra charge. Additional bold face (not available as all caps) 50¢ per word additional (20% premium). Entire ad in boldface, add 20% premium to total price. **TINT SCREEN BEHIND ENTIRE AD:** add 25% premium to total price. **TINT SCREEN BEHIND ENTIRE AD PLUS ALL BOLD FACE AD:** add 45% premium to total price. **EXPANDED TYPE AD:** \$4.30 per word prepaid. All other items same as for **STANDARD COMMERCIAL RATE**. **TINT SCREEN BEHIND ENTIRE EXPANDED TYPE AD:** add 25% premium to total price. **TINT SCREEN BEHIND ENTIRE EXPANDED TYPE AD PLUS ALL BOLD FACE AD:** add 45% premium to total price. **DISPLAY ADS:** 1" x 2 1/4"—\$310.00; 2" x 2 1/4"—\$620.00; 3" x 2 1/4"—\$930.00. General Information: Frequency rates and prepayment discounts are available. **ALL COPY SUBJECT TO PUBLISHERS APPROVAL. ADVERTISEMENTS USING P.O. BOX ADDRESS WILL NOT BE ACCEPTED UNTIL ADVERTISER SUPPLIES PUBLISHER WITH PERMANENT ADDRESS AND PHONE NUMBER.** Copy to be in our hands on the 12th of the third month preceding the date of the issue. (i.e., August issue copy must be received by May 12th). When normal closing date falls on Saturday, Sunday or Holiday, issue closes on preceding working day.

BLACK BOX DE-SI-FURING THE SOLUTION TO SATELLITE SCRAMBLING VOL. II

AMERICAN AND CANADIAN
Latest Satellite Technology available. Over 100 pages of how to build. Comes with complete schematics. Parts lists and suppliers of parts & kits.

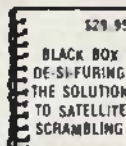

\$29.95

BLACK BOX DE-SI-FURING THE SOLUTION TO SATELLITE SCRAMBLING

CONTENTS OF MANUAL

- 4 different types of satellite scrambling
- Modes of operation
- How to build a De-Si-Fur
- Digital audio & CRT controllers
- Digital audio processors
- Schematic dia

to receive more information, please money order only for \$29.95 plus \$3.00 shipping & handling. **CALL ORDER LINE (401) 333-8775 BELLRAE DIST. CO., P.O. Box 41, Warren, RI 02885**

SATELLITE systems \$449.00, catalog \$2.00. Also: KU band; exports. **STARLINK, INC.**, 2603-16R Arlie, Huntsville, AL 35805.

TRIPLE-X Satellite TV Descrambler Information. XXX - Adult Movies, ready to go - \$225.00. **NAS-SAT**, Box 5261, Long Beach, CA 90805, (213)631-3552.

DESCRAMBLERS. We have a new computerized descrambler. Will unscramble Canadian channels plus more. XXX available. For more information call **J.R. ELECTRONICS**, (616)781-4623.

MASTERCARD AND VISA are now accepted for payment of your advertising. Simply complete the form on the first page of the Market Center and we will bill.

ATTENTION satellite dealers. See everything with your video cypher 2000 demonstrator on all the transponders. (Secret modification voids warranty.) Send \$24.00 for VC kit. **TV SHOP**, 127 E. Mission, Fallbrook, CA 92028.

SATELLITE TV VIEWERS

Get the most complete weekly listings. Send \$1 for sample copy.

Satellite TV Week

P.O. Box 308E, Fortuna, California 95540
800-358-9997 (U.S.) - 800-358-8787 (Calif.)
707-722-3476 (all others)

PATENTED optical process satellite sound system for information. Send \$3.00 to: **BEDINI ELECTRONICS**, PO Box 769, San Fernando, CA 91341.

59 degree brand name **LNA's!** LNB's! Ku-Band LNB's! Discount pricing! Send stamped envelope: **LNA**, 201 E Southern, Suite 100E, Tempe, AZ 85282.

FOR SALE

TUBES new, unused. Send self-addressed, stamped envelope for list. **FALA ELECTRONICS**, Box 1376-2, Milwaukee, WI 53201.

LINEAR parts, tubes, transistors—MRF454 \$16, MRF455 \$12, MRF477 \$11, MRF492 \$16. Catalog. **RFPC**, Box 700, San Marcos, CA 92069 (619)744-0728.

AUGUST 1986

87

RESTRICTED technical information: Electronic surveillance, schematics, locksmithing, covert sciences, hacking, etc. **huge selection** Free brochure: MENTOR-Z, 135-53 No. Blvd., Flushing, NY 11354.

OLDTIME radio programs on high quality tapes. Comedy! Adventure! Music! Free catalogue. CARL F. FROELICH, Heritage Farm, New Freedom, PA 17349.



REMOVES VOCALS FROM RECORDS!
Now You can sing with the world's best bands! The Thompson Vocal Eliminator can remove most or virtually all of a lead vocal from a standard stereo record and leave the background!
Write or call for a free brochure and demo record.
LT Sound, Dept. R-1, P.O. Box 338,
Stone Mountain, GA 30086 (404) 493-1258

CORDLESS phone interference? We've got the answer. Have a radar speeding ticket? We can help. Home phone extension in your car? You can have it. 50-page color catalog aimed at \$3.00. DBE, P.O. Drawer G, Walkie, HI 96830.

ELECTRON Tubes—radio, TV & industrial types—huge inventory. Call toll free (800-221-5802) or write **Box ESC TRANSELETRONIC, INC.,** 1365 39th St., Brooklyn, NY 11218. (718) 833-2800.

WHOLESALE catalog of unusual money making electronic items. Dealers wanted. Rush \$1. **CROSLEY (A),** Box 840, Champlain, NY 12919.

T.V. tunable notch filters, free brochure. **D.K. VID-ED,** Box 63/6025, Margate, FL 33063. (305) 752-9202.

Quality Microwave TV Antennas
Multi-Channel 1.9 to 2.7 GHz
40dB Gain True Parabolic 20 Inch Dish
Complete System \$99.95 (plus shipping)
Dealerships, Qty. Pricing, Replacement Parts
Philips-Tech ELECTRONICS
P.O. Box 8888 • Scottsdale, AZ 85252
(602) 947-7700 \$3.00 Credit all phone orders!
MasterCard • Visa • C.O.D.

ANTIQUE radio hobbyists — 20 page catalog of tubes, parts, and literature for radio restoration. Send \$2.00 to **ANTIQUE ELECTRONIC SUPPLY,** 688 W. First St., Tempe, AZ 85281.

CABLE-TV converters and equipment. Plans and parts. Build or buy. **FREE** information. **C&D ELECTRONICS,** PO Box 1402, Dept. RE, Hope, AR 71801.

35 - 70% savings — bargain catalog for 39 cents stamp. **APEX ELECTRONICS MOD.** 8909 San Fernando, Sun Valley, CA 91352

TURBO circuit analysis generates matrix equations for AC, DC and transient analysis. Source code for worst case, plots. Requires MS-DOS and turbo pascal or fortran. **VISA/MC \$155. CLIFFORD VANDER YACHT, COMPUTER CONSULTANT,** 3778 Hitching Post Road, Jackson, MI 49201. (517) 782-2297.

TEST equipment, reconditioned, For sale. \$1.25 for catalog. **WALTER'S,** 2697 Nickel, San Pablo, CA 94806. (415) 724-0587.

LASERS and nightvision surplus components. Free catalog. **M.J. NEAL COMPANY,** 6672 Mallard Ct., Orient, OH 43146.

TI-99 4A software/hardware bargains. Hard to find items. Huge selection. Fast service. Free catalog. **DYNA,** Box 690 Hicksville, NY 11801.

CABLE-TV converters and descramblers. Low prices, quality merchandise, we ship C.O.D. Send \$2.00 for catalog. **CABLETRONICS UNLIMITED,** P.O. Box 266, South Weymouth, MA 02190. (617) 871-6500.

DESCRAMBLER plans for Jerrold, Theory, schematic, parts list, waveforms. For speedy delivery send \$10.00 cash or money order. **BAY STATE ELECTRONICS,** P.O. Box 63, Accord, MA 02018.

FREE ADAPTER (limited offer) with **AS-SORTMENT #103**—consisting of TOKO Coils 144LY-12 OK, 520 HN-3000023, BKAN-K555AXX (2); PCB; Transistors 2N3904 (2), BFQ85 (Sub); IC'S 7812, #74123, MC1330A1P; Diodes 1N914, 1N5231B. Only \$25.00 10% Discount for 5 or more Shipping \$3.00/order **MC/Visa/COD.** Toll Free 1-800-821-5226 Ext. 426 (orders). **JIM RHODES, INC.** 1025 Ransome Lane, Kingsport, TN 37660.

TUBES, name brands, new, 80% off list. **KIRBY,** 298 West Carmel Drive, Carmel, IN 46032

INDIVIDUAL Photofact-folders #1 to #1400. \$3.00 postpaid. **LOEB,** 414 Chestnut Lane, East Meadow, NY 11554.

WRITE FOR
McGEE'S
SPEAKER & ELECTRONICS CATALOG
100+ BARGAINS IN SPEAKERS
toll free 1-800-346-2433 for ordering only.
1901 MCGEE STREET KANSAS CITY, MO. 64106

SB3 descrambler parts to construct project in Feb-84 Radio-Electronics \$49.95 (Dealer inquires invited). **CROSLEY,** Box 840, Champlain, NY 12919.

WORLDS best channel 3 notch filter. \$19.95. (Dealer inquires invited). **CROSLEY (A),** Box 840, Champlain, NY 12919.

THE NEW 65/9028 VT ANSI VIDEO TERMINAL BOARD!
• FROM LINGER ENTERPRISES •

A second generation, low cost, high performance, mini sized, single board for making your own RS232 Video Terminal. Use as a computer console or with a MODEM for hook up to any of the telephone-line computer services.

FEATURES:

- Uses the new SMC 9028 Video Controller Chip Coupled with a 6502A CPU.
- RS-232 at 16 Baud Rates from 50 to 19,200
- On board Printer port
- 24 X 80 format (50/60 Hz).
- For 15.750 Hz (Hertz.) monitors.
- 3 Terminal Modes: H-1B, ADM3A, and ANSI X 3.64-1979
- Wide and thin-line graphics.
- While characters on black background or reversed.
- Character Attributes: De-Inten, Inverse or Underline.
- Low Power: 5VDC @ .7A, ± 12VDC @ 20MA.
- Mini size: 6.5 X 5 inches.
- Composite or split video.
- 5 X 8 Dot Matrix Characters (U/L case).
- Answer back capability.
- Battery backed up status memory.
- For ASCII parallel keyboard.

MICRO SIZE!

\$99.95 (Full Kit)

SOURCE DISKETTE: PC/XT FORMAT 5 1/4 IN. \$15

ADD \$40 FOR A&T

Digital Research Computers
(OF TEXAS)
P.O. BOX 381450 • DUNCANVILLE TX 75138 • (214) 225-2309

Call or write for a free catalog on Z-80 or 6809 Single Board Computers, SS-50 Boards, and other S-100 products.

TERMS: Add \$3.00 postage. We pay balance. Orders under \$15 add 75c handling No C.O.D. We accept Visa and MasterCard. Texas Res. add 8-1/2% Tax. Foreign orders (except Canada) add 20% P & H. Orders over \$50 add 85c for insurance.

HIGH VOLTAGE TRIPLERS/MULTIPLIERS
REPLACEMENT FOR
ECG®/GE®/SK®

500A/GE527 & SK3304	8.75	6.95
523/GE528 & SK3306	8.85	7.20
526A/SK3306	8.85	7.20
528/SK3906	10.70	8.70
529/GE529 & SK3307	9.99 5 MIN	7.95 100 MIN.

OUTPUT TRANSISTORS

165/SK3115 & GE39	2.25	1.95	1.75
238/GE37 & SK3710	2.25	1.95	1.75
283/SK3467	2.75	2.35	1.80
25D1341P	2.25	1.95	1.75
25C1172B	2.25 5 MIN.	1.95 50 MIN.	1.55 100 MIN.

AUDIO POWER

TYPE	10 min	50 min	100 min	TYPE	10 min	50 min	100 min	TYPE	10 min	50 min	100 min
192/SK3895	.30	.25	.21	188/SK3054	.49	.44	.39	281/SK5440	.49	.44	.39
183/SK3274	.30	.25	.21	187/SK3085	.39	.34	.29	282/SK3441	.49	.44	.39

RECTIFIER DIODES

125	1000V/2.5A	7¢	6¢	5¢
156	1000V/5A	18¢	16¢	13¢
506	DAMPER/HV-VOLT - FAST RECOVERY	29¢	24¢	19¢

\$\$ ADDITIONAL SAVINGS \$\$

TYPE	10 min	50 min	100 min	TYPE	10 min	50 min	100 min
102A	.35	.32	.29	171	.49	.44	.38
123A	.18	.16	.14	184	.38	.33	.28
123AP	.13	.11	.09	185	.38	.33	.28
128	.38	.35	.29	198	.60	.54	.49
129	.38	.35	.29	199	.16	.15	.12
130	.59	.55	.49	234	.19	.16	.15
159	.16	.15	.11	375	.44	.42	.39
162	2.25	1.95	1.49	712	.75	.69	.60
163A	2.35	1.99	1.55				

FOR A COMPLETE LIST CALL OR WRITE—C.O.D. Orders Welcome (Min. Order \$25)
DIGITRON ELECTRONICS
110 HILLSIDE AVENUE SPRINGFIELD, NEW JERSEY D7081
Toll Free 1-800-526-4928 In NJ 201-378-901a Telex 138421
PRICES SUBJECT TO CHANGE WITHOUT NOTICE. OFFER GOOD WHILE SUPPLY LASTS.
ECG is a Trade Mark of Philips ECG. Digitron Ele. not associated with Philips ECG.

AMAZING DEVICES

PHASORS

- PLANS**—All Parts Available in Stock
- LCS BURNING CUTTING CO2 LASER ... \$20.00
 - RUB3 RUBY LASER RAY PISTOL ... 20.00
 - BTCS 1.5 MILLION VOLT TESLA COIL ... 15.00
 - PGT1 PLASMA TORNADO GENERATOR 10.00
 - GRA1—GRAVITY GENERATOR ... 10.00
 - MAGNETIC CANNON PROJECTOR ... 10.00

LASERS

- KITS**—Includes Plans and Parts
- LHC2K SIMULATED RED/GRN/YEL LIGHT LASER ... 34.50
 - BTC3K 250,000 VOLT TESLA COIL ... 159.50
 - 10G1K ION RAY GUN ... 109.50
 - PSP3K PHASOR SHOCK WAVE PISTOL 49.50
 - STG1K—STUN/PARALYZING GUN ... 39.50
 - INF1K INFINITY TRANSMITTER ... 134.50
 - MFT1K 2-3 MILE RANGE FM VOICE XMTR PC BOARD ... 49.50

SECURITY

- ASSEMBLED AND TESTED PRODUCTS**
- LGU30 RED 1MW PORTABLE HEAT LASER ... 349.50
 - TCL30 SOLID STATE TESLA COIL 35KV 84.50
 - IPG50 POCKET PAIN FIELD GENERATOR 64.50
 - BLS10 BLASTER DEFENSE WEAPON ... 89.50
 - ITM10—100KV SHOCK AND STUN GUN 99.50
 - PPF10 PHASOR PAIN FIELD PORTABLE 249.50
 - SNP20 SECURITY PHONE LISTENER ... 99.50

• CATALOG CONTAINING DESCRIPTIONS OF ABOVE PLUS HUNDREDS MORE AVAILABLE FOR \$1.00 OR INCLUDED FREE WITH ALL ABOVE ORDERS.

PLEASE INCLUDE \$3.00 PH ON ALL KITS AND PRODUCTS. PLANS ARE POSTAGE PAID. SEND CHECK, MO, VISA, MC TO

INFORMATION UNLIMITED

P.O. BOX 716, DEPT. M1 AMHERST, NH 03031

Technicians,
Get Serious
About Your
Profession



Being a certified electronics technician lets people know that you are a professional in your field. It tells them that you are serious about your work and can perform up to CET standards.

Now you can order the "Study Guide for the Associate-Level CET Test" from the International Society of Certified Electronics Technicians. It includes material covering the most often missed questions on the Associate CET Exam. 8 1/2" x 11", paperback, 60 pages.

For More Information Contact:

IS CET 2708 W. Berry, Ft. Worth, TX 78108. (817) 921-9101

NAME _____
ADDRESS _____
CITY _____ STATE _____
ZIP _____

copies @ \$5 (+ \$1 postage.)

send material about IS CET and becoming certified.

FAST A/D converters. Five bit 90 nsec A/D converter module offers 5 MHz effective bandwidth for \$25 (DA 0175) — build video frame grabber. Eight bit 200 nsec sampling A/D converter for \$40 (DA 0188) — add memory and trigger to make digital storage scope peripheral for PC for less than \$100. Send SASE for product specification. **DIPAC ASSOCIATES**, 645 Executive Center Dr #204, West Palm Beach, FL 33401.

NEW! telephone/intercom. Control \$70.00. Phones \$45.00. Detailed information \$1.00. (317)632-8377. **SAYLOR ENTERPRISES**, PO Box 2083, Indianapolis, IN 46206-2083.

COMPLETE variable regulated computer grade power supply 1.5 to 25 volts 20,000 microamperes 5 amperes maximum output. **DENNIS SPENNER** PO Box 165, Centralia, IL 62801. Send \$94.00.

CABLE TV converters—all major brands. Wireless remotes with volume, wired remotes. Cable and video accessories. Lowest prices. Ship COO. Catalogs \$3.00. **SONE ASSOCIATES**, 256 Broadway, Suite 201, Troy, NY 12180. (518)274-0608.

ELECTRONICS. \$1.50 brings flyer, grab bag. **LYNN JOHNSON**, 2221 The Alameda #176, Santa Clara, CA 95050.

TESLA coil construction plans, Kirlian electrophotography plans. Free information/photo. **SCIENTIFIC**, Box 962RE8, Norco, CA 91760.

CUSTOM TRS-80 and Apple character generators. Send SASE for details. **CPU INTERNATIONAL**, 11604 Starlight Ave., Whittier, CA 90604.

BATTERIES NiCad, sealed lead acid, Alkaline and more from national brands like Panasonic, Eagle-Picher, Duracell and others. Write or call for listing. **D.C. POWER INC.**, 1213 Old Colony Rd., Wallingford, CT 06492. (203)237-2292.

SOFTWARE, hardware, audio kits, solar cells, surplus items, much more. Free catalog. **GIL ELECTRONICS**, Box 1628-G, Soquel, CA 95073.

BUSINESS OPPORTUNITIES

MECHANICALLY inclined individuals desiring ownership of small electronics manufacturing business — without investment. Write: **BUSINESSES**, 92-R, Brighton 11th, Brooklyn, NY 11235.

YOUR own radio station! AM, FM, TV, Cable. Licensed/unlicensed. **BROADCASTING**, Box 130-FB Paradise, CA 95969.

HUNDREDS weekly! Become circular mailer. Home-operated! Sincerely interested, rush stamped envelope. **NATIONAL MAILING**, Box 19759-RAB, San Diego, CA 92119.

MAKE money in electronics! Send SASE for free starter kit! **LAFAYETTE PUBLISHING**, Dept 1-E, Box 336, Lafayette, CA 94549.

BIG PROFITS ELECTRONIC ASSEMBLY BUSINESS

Start home spare time investment knowledge or experience unnecessary. **BIG DEMAND** assembling electronic devices. Sales handled by professionals. Unusual business opportunity.

FREE: Complete illustrated literature
BARTA, RE-O Box 248
Walnut Creek Calif 94597

EDUCATION & INSTRUCTION

F.C.C. Commercial General Radiotelephone License. Electronics home study. Fast, inexpensive! "Free" details. **COMMAND**, D-176, Box 2223, San Francisco, CA 94126.

JERROLD gated pulse theory. Twelve information packed pages covering DI & DIC converter operation. Includes introduction to trimode system. \$6.95. **ELEPHANT ELECTRONICS**, Box 41865-J, Phoenix, AZ 85080. (602)581-1973.

FCC Commercial General Radiotelephone License Correspondence Course. 60 individual lessons for \$89.50. Payment plan. Results guaranteed! Details free. **AMERICAN TECHNICAL INSTITUTE**, Box 201, Cedar Mountain, NC 28718.

LEARN to be a television studio technician! After only 14 months earn your degree and a great career in video. Financial aid and national placement assistance. Dallas (214)263-2613 or Long Beach (213) 595-1660. **VIDEO TECHNICAL INSTITUTE**.

COMPUTER repair career training in 5 months by accredited Florida electronics school. Lifetime placement. Financial assistance if qualified. Call **SYSTEMS TECHNOLOGY INSTITUTE**. (305) 331-2840.

THIS IS AN EXPANDED TYPE AD. Notice how it stands out on this page. To get your ad set in this type style mark your classified ad order, "Expanded-type ad," and calculate your cost at \$3.75 per word.

PRINTED CIRCUIT BOARDS

PCB 15 cents sq-in. free drilling. Quantity discounts. Professional work. **INTERNATIONAL ENTERPRISE**, 6452 Hazelcreek, Simsbury, CT 06063.

GUARANTEED lowest quotes, fast service, average \$.12 per square inch (FR-4), prototype through production quantities. Call or send specifications for quotes. **Electronic Components** catalog—send SASE. **TORCCC ELECTRONICS**, Box 47148, Chicago, IL 60647. (312)342-9171.

INVENTORS

INVENTORS! Can you patent and profit from your idea? Call **AMERICAN INVENTORS CORPORATION** for free information. Over a decade of service. 1-800-338-5656. In Massachusetts or Canada call (413) 568-3753.

EPROM PROGRAMMING

HOBBYISTS: Pretested eproms sold with your programming installed. Program listing provided. Fast service. Write or call. **ROMULUS MICROCONTROL**, Box 8669, Rockville, MD 20856. (301)540-8863.

WANTED

INVENTORS! AIM wants—ideas, inventions, new products, improvements on existing products. We present ideas to manufacturers. Confidentiality guaranteed. Call toll free 1-800-225-5800 for information kit.

INVENTIONS, ideas, new products wanted! Industry presentation/national exposition. Call free 1-800-528-6060. Canada, 1(800)528-6060. X831.

REEL-TO-REEL TAPES

AMPEX professional series open reel tape. 1800- or 2400-feet on 7-inch reels. Used once. Case of 40, \$45.00. 10 1/2 x 3600 feet and cassettes available. MasterCard Visa. **VALTECH ELECTRONICS**, Box 6-RE, Richboro, PA 18954. (215) 322-4866.

DO IT YOURSELF TV REPAIR

NEW...repair any TV...easy Anyone can do it. Write, **RESEARCH**, Rt3 Box 601BR Colville, WA 99114.

LASERS

LASERS He-Ne audio modulated with remote receiver commercial surplus ready to use \$179.95PPD. SASE for specifications. **LES ELECTRONICS CORP.** P.O. Box 800276, Dallas, TX 75380. (214)867-3272.

COMPUTER SOFTWARE

WIN at casino blackjack! Disk includes game, play analyzer, and powerful point count system. Proves itself on your machine. For IBM-PC (no graphics card req.) ATARI 800 (48K)/XL/XE Specify. \$19.95. **BISONSOFT**, Box 2136, Bloomington, IN 47402.

★ QUALITY PARTS ★ DISCOUNT PRICES ★ FAST SHIPPING!

SEND FOR FREE 1986 CATALOG... 48 PAGES!

ALL ELECTRONICS CORP.

EDGE CONNECTORS

ALL ARE 1.94" SPACING.

- 27 EDGE CONNECTOR \$2.25 ea solder lug style 30 for \$11.00
- 28/44 EDGE CONNECTOR \$3.00 ea PC style 10 for \$18.00
- 29/44 EDGE CONNECTOR solder lug style \$2.50 each
- 29/86 EDGE CONNECTOR \$2.50 ea PC style 10 for \$22.00
- 36/72 EDGE CONNECTOR PC style \$3.00 each
- 43/86 EDGE CONNECTOR PC style \$4.50 each

TRANSISTORS

- 2N706 8 for \$1.00
- 2N2222A 3 for \$1.00
- PN2222A 4 for \$1.00
- 2N2904 3 for \$1.00
- 2N2905 2 for \$1.00
- MJ2955 \$1.50
- 2N3055 \$1.00
- PMO 10K40 \$1.00
- TIP 121 75¢
- TIP 125 75¢

TRANSFORMERS

- 120 volt primaries
- 5.0 volts @ 750 ma. \$3.00
- 6.0 volts @ 100 ma. \$1.25
- 6.3 volts @ 600 ma. \$3.00
- 12 VOLT @ 700 ma. \$2.00
- 12 VOLT @ 400 ma. \$2.00
- 12 VOLT @ 1 amp \$4.00
- 12 VOLT @ 2 amp \$4.25
- 12 VOLT @ 4 amp \$9.00
- 18 volts @ 650 ma. \$2.00
- 24 VOLT @ 250 ma. \$2.00
- 24 VOLT @ 1 amp \$4.65
- 24 VOLT @ 2 amp \$6.75
- 24 VOLT @ 3 amp \$9.50
- 24 VOLT @ 4 amp \$11.25
- 36 VOLT @ 1.5 amp \$3.00

WALL TRANSFORMERS

- all plug directly into 120 vac outlet
- 4 VDC @ 70 ma. \$2.00
- 5 VDC @ 500 ma. \$3.50
- 5 VDC @ 750 ma. \$4.00
- 6 VDC @ 500 ma. \$3.00
- 12.6 VDC @ 245 ma. \$3.00
- 16 VDC @ 16 VA and \$3.50
- 18 VDC @ 1.25 amp \$3.50
- 24 VDC @ 250 ma. \$3.00
- MULTI-VOLTAGE @ 500 ma. \$3.45, \$3.75, or \$4.25

MINI-BOX

Pomona #2104 Heavy-duty black phenolic project box with cover and screws. 2 1/4" x 1 1/4" x 1 1/2"

FUSES

- 3AG (AGC) SIZE 1, 1 1/2, 2, 2 1/2, 3, 4, 5, 6 AMP
- GAMA SIZE 1, 2, 3, 4, 5 AMP
- 5 of 975 ONE amp @ 75¢

SOUND AND VIDEO MODULATOR FOR T.I. COMPUTER

TL # UM1381-1. Designed for use with T.I. computers. Can be used with video sources. Built-in A/B switch. Channel 3 or 4 selection switch. Operate on 12 vdc. Hook-up diagram included.

CAT# AVMOD WERE \$10.00 REDUCED TO \$5.00 EACH

SLIM LINE COOLING FAN

En 5 x 9 x 1/2 low noise fan. Measures 3 1/4" square x 1" deep. 21 cfm, 23 db, 1700 rpm.

SPECIAL PRICE... \$1.99 each

2K 10 TURN SOLID STATE BUZZER

MULTI-TURN POT SPECTROL #MCD 634-7161 \$5.00 EACH

Star # SSB 06L 6 vdc TTL compatible \$1.00 each 10 for \$9.00

± 12 Vdc or 24Vdc POWER SUPPLY

DELTRON MODEL QD12/15-L7 Dual plus and minus 12Vdc open frame power supply. Can be used at 24Vdc @ 1.5 amp. INPUT either 115 vac or 230 vac. Fully regulated computer grade supply. 7" x 4 1/2" x 2 1/4"

\$12.50 each 10 for \$110.00

SPECIALS

1 AMP 50 VOLT DIODES

14001 TYPE AND REEL 100 for \$4.50 1000 for \$30.00

SOLDER TAIL I.C. SOCKETS

24 PIN 10 for \$2.50 100 for \$22.00 1000 for \$200.00

SPECIAL PRICE TRANSISTOR

plastic transistor PN3569 TO 92 N P N 100 for \$8.00 1000 for \$80.00 LARGE QUANTITIES AVAILABLE

48 KEY ASSEMBLY FOR COMPUTER OR HOBBYIST

NEW T.I. KEYBOARDS. Originally used on computers, these keyboards contain 48 S.P.S.T. mechanical switches. Terminates to 15 pin connector. Frame 4" x 9". CAT# KP-48 \$6.50 each 2 for \$11.00

TI SWITCHING POWER SUPPLY

Compact, well-regulated switching power supply designed to power Texas Instruments computer equipment.

INPUT 14-25 vac @ 1 amp
OUTPUT +12 vdc @ 350ma
-5 vdc @ 12 amp
-8 vdc @ 200 ma.

SIZE 4 1/2" x 4 1/2" x 1 1/2" high

\$3.50 each

13.8 VDC REGULATED POWER SUPPLY

These are solid state, fully regulated 13.8 vdc power supplies. Both feature 100% solid state construction, fuse protection, and L.E.D. power indicator light.

3 amp constant, 4 amp surge \$26.00 each
3 amp constant, 5 amp surge \$27.50 each

D.C. CONVERTER

Designed to provide a steady +5 vdc @ 240 ma. from a battery supply of 3.5 to 25 volts.

2 1/2" x 1 1/2" x 1 1/2" \$1.80 each

MICRO-CASSETTE MECHANISM

Micro-cassette tape transport for standard MC80 or MC45 micro-cassettes. 3 Vdc operation. Contains: drive motor, belt, head, capstan, pinch wheel and other components. 3 1/2" X 2 1/4" X 5/8"

CAT# MCMEC \$3.00 each 10 for \$27.50

COMPUTER GRADE CAPACITORS

- 2,000 mfd. 200 vdc 1 3/4" x 5" high \$2.00
- 5,400 mfd. 60 vdc 1 3/8" x 3 3/4" high \$2.50
- 9,700 mfd. 50 vdc 1 3/8" x 4 1/2" high \$3.00
- 11,000 mfd. 16 vdc 1 3/4" x 4" high \$2.50
- 50,000 mfd. 40 vdc 3" x 3 3/4" high \$4.50
- 80,000 mfd. 40 vdc 3" x 5" high \$2.50
- 80,000 mfd. 15 vdc 3" x 3 3/4" high \$3.00
- 86,000 mfd. 30 vdc 3" x 5 1/4" high \$3.50

RECHARGEABLE NI-CAD BATTERIES

AAA SIZE 1.25V 500MAH \$1.85
AA SIZE 1.25V 500MAH \$1.85
AA with solder tab \$2.00
C SIZE 1.2V 1200MAH \$3.50
SUB-C SIZE solder top \$3.50
D SIZE 1.2V 1200MAH \$3.50

UNIVERSAL CHARGER

Will charge 4 AA, C, D, or AAA nicads or one 9 volt nicad at one time.

\$11.00 per charger

RECHARGEABLE NI-CAD BATTERIES

AAA SIZE 1.25V 500MAH \$1.85
AA SIZE 1.25V 500MAH \$1.85
AA with solder tab \$2.00
C SIZE 1.2V 1200MAH \$3.50
SUB-C SIZE solder top \$3.50
D SIZE 1.2V 1200MAH \$3.50

PHOTO-FLASH CAPACITORS

170 mf 330v Three sizes available.
70¢ ea. CAT# PPC-170
400 mf 330v Full range capacitor. 1.80 ea. CAT# PPC-400
800 mf 330v 8.25 ea. CAT# PPC-800

RELAYS

10 AMP SOLID STATE

CONTROL 3 - 32 vdc LOAD 160 ma 10 amp SIZE 2 1/2" x 1 1/2" x 1"

\$9.50 EACH 10 FOR \$90.00

ULTRA-MINIATURE 5 VDC RELAY

Fujitsu # FUJITSU MHD0500 High sensitivity COIL: 120 ohms CONTACTS: 1 amp Mounts on 14 pin DIP socket \$1.25 each 10 for \$10.00

MINIATURE 6 VDC RELAY

Aromat #RSD-6V Super Small S.P.D.T. relay GOLD contact contacts rated 1 amp @ 30 vdc. Highly sensitive TTL direct drive possible. 120 ohm coil. Operates from 4.3 - 6 vdc. COIL: 120 ohms \$1.50 each 17 1/2" x 7 1/2" x 1 1/2" 10 for \$13.00

13 VDC RELAY

CONTACTS: S.P.D.T. 10 amp @ 120 vac Energize coil to open contact COIL: 13 vdc 650 ohms

SPECIAL PRICE \$1.00 each

4PDT RELAY

14 pin 104 style 3 amp contacts. USED but fully tested. \$1.70 each Specify coil voltage desired. Either 24 vdc or 120 vac. LARGE QUANTITIES AVAILABLE

FLASHER LED

5 volt operation red jumbo T 1 1/4 size \$1.00 each

NEW GREEN FLASHER CAT# LED-4G \$1.00

LED HOLDERS

Bag piece holder for jumbo LED 10 for \$5.00 100 for \$5.00

CLEAR CLIPUTE LED HOLDER Max 6 LED a fancy indicator Clear 4 for \$1.00

3 1/2" SPEAKER

8 ohm impedance. Full range speaker. 8 or magnet 4" diagonal mounting centers

\$3.50 each 10 for \$30.00

SPRING LEVER TERMINALS

Two color coded terminals on a sturdy 2 1/2" x 3 1/4" Delcote plate. Great for speaker enclosures or power supplies.

75¢ EACH 10 for \$6.00

MINIATURE TOGGLE SWITCHES

ALL ARE RATED 5 AMPS @ 125 VAC

S.P.D.T. (on-on) PC style non-threaded bushing \$1.00 each 10 for \$7.00

S.P.D.T. (on-off-on) Solder lug terminals \$1.00 each 10 for \$9.00 100 for \$80.00

S.P.D.T. (on-on) PC style threaded bushing \$1.00 each 10 for \$9.00 100 for \$80.00

D.P.D.T. (on-on) Solder lug terminals \$2.00 each 10 for \$18.00 100 for \$180.00

STANDARD JUMBO DIFFUSED T 1-3/4

RED 10 for \$1.50 100 for \$15.00
GREEN 10 for \$2.00 100 for \$17.00
YELLOW 10 for \$2.00 100 for \$17.00

D.R.S.T. LIGHTED ROCKER SWITCH

115 vac lighted rocker snap mounts on 1/2" x 1 1/4" hole. Orange lens. 16 amp contact \$1.50

MINI-PUSH BUTTON

5 P.S.T. momentary normally open 1/4" bushing. Red button. 35¢ each 10 for \$3.00

SNAP ACTION SWITCH

Cherry elect. #E-21. N.O. or N.C. 0.1A contacts. Suitable for alarms and other low energy circuits. 1 1/2" lever. 48¢ EACH 10 FOR \$4.20

TWO WIRE

8 18/2 SPT-1 3 for \$1.00
8 18/2 SPT-2 2 for \$1.00
8 18/2 S/T round \$1.25 each

THREE WIRE

8 18/3 1.50 each
8 18/3 round \$2.00 each

7 CONDUCTOR RIBBON CABLE

Spectra-strip red marker strip. 28 ga. stranded wire \$5.00 per 100' roll

XENON FLASH TUBE

3/4" long X 1/8" dia. Flash tube designed for use in compact camera flash units. Ideal for experimenters. CAT# FLT-1 2 for \$1.00

220 Vac COOLING FAN

ROTRON # UX77A3 Muffin XL 220 Vac 4 1/8" square metal frame fan. CAT# CF-220 \$4.50 ea. 10 for \$50.00; 100 for \$500.00. QUANTITIES AVAILABLE

LOS ANGELES, CA STORE
905 S Vermont Ave.
213 380 8000

VAN NUYS, CA STORE
6228 Sepulveda Blvd.
818 997-1806

MAIL ORDERS TO:
P.O. BOX 20406
Los Angeles, CA 90006

TWx - 51010163 ALL ELECTRONIC
EASYLINK MBX - 6286748

TOLL FREE ORDERS ONLY
1-800-826-5432
ORDER ONLY
IN CALIFORNIA: 1-800-258-6666
ALASKA HAWAII
OR INFORMATION
2131380 8000 NO C.O.D.

QUANTITIES LIMITED
MINIMUM ORDER \$10.00
USA: \$3.00 SHIPPING
FOREIGN ORDERS
INCLUDING SUFFICIENT
SHIPPING
CALIF. RES. ADD 6 1/2%

PLANS AND KITS

CATALOG Hobby/broadcasting/1750 Meters/Ham/ CB: transmitters, amplifiers, antennas, scramblers, bugging devices, more! **PANAXIS**, Box 130-F8, Paradise, CA 95969.

Hi-Fi speaker systems, kits, auto speaker systems and speaker components from the world's finest manufacturers. For beginners and audiophiles. Free literature. **A&S SPEAKERS**, Box 7462R Denver, CO 80207 (303)399-8609.

VOICE disguisers! Telephone bugs! FM bugs! Other kits! Send stamped envelope: **XANDI**, Box 25467, Dept. 60A, Tempe, AZ 85282.

SAVE money, energy! Circuit makes batteries last longer! Use in your own invention! State of the art. Almost anyone can build. Plans \$10.00. **WAYNE KESSLER**, Box 685, Plymouth Meeting, PA 19462.

CABLE TV CONVERTERS: Jerrold products include "New Jerrold TRI-MODE", SB-3, Hamlin, Oak VN-12, M-35-B, Zenith, and more. UHF deluxe II kits (quantity discounts) 60 day warranty. Service converters sold here. For fast service COD orders accepted. Send S.A.S.E. (60 cents postage) or call for info. (312) 637-4408. **HIGGINS ELECTRONICS 5143-R W. Diversey, Chicago, IL 60639. No Illinois orders accepted.**

STEREO simulator. Plans, parts and PCB only \$15 plus \$2 shipping. **DAVIS ELECTRONICS**, Box 27552, West Allis, WI 53227.

CB MODIFICATIONS

Increase channels, range, privacy! We specialize in frequency expanders, speech processors, FM converters, PLL & slider tricks, how-to books, plans, kits. Expert mail-in repairs & conversions. 16-page catalog \$2. Our 11th year!

CBC INTERNATIONAL P.O. BOX 31500RE, PHOENIX, AZ 85046

FREE catalog 99-cent kits-audio, video, TV computer parts. **ALLKIT 434 W. 4th St. West Islip, NY 11795.**

CRYSTAL radio sets, plans, parts, kits, catalog \$1.00. **MIDCO**, 660 North Dixie Highway, Hollywood, FL 33020.

Pay TV and Satellite Descrambling All New 6th Edition!

Now over 100 pages of working schematics, theory and "hard" information on all the major cable and over the air scrambling systems. Schematics and theory for all 4 satellite descrambling systems used currently: HBO, Anik-D, Fantasy, Extasy etc. New sections on digital audio coding and bypassing. Insider information included. Still the most complete source of descrambling info available \$14.95. Satellite Systems Under \$600, \$11.95. MOS Handbook \$10. Stun gun schematics \$5. Enlarged product catalog of PC's, kits and low cost satellite equipment \$2.

**Shojiki Electronics Corp., 1327R
Niagara St., Niagara Falls, NY
14303. COD's 716-284-2163**

BUILD this five digit panel meter and square wave generator including an ohms, capacitance and frequency meter. Detailed instructions \$2.50 refundable plus 50 cents. **BAGNALL ELECTRONICS**, 179 May, Fairfield, CT 06430.

DESCRAMBLER plans, new design decodes gated sync suppressed signals—newest pilotless method. Circuit boards, most parts from Radio Shack. Detailed theory, drawings, schematics, instructions \$14.95 plus \$2.00 shipping. **DIRIJO CORP.**, Box 212 Lowell, NC 28098.

NEW! Fiber optic voice link. Send your voice over a beam of light via an optical fiber. Complete kit includes microphone, speaker, fiber, PCB'S and all parts. Easily assembled. Introductory offer—send \$34.95 to: **FIBER SCIENCES, KIT-73A, PO Box 5355, Chatsworth, CA 91313-5355 CA residents add 6.5%.**

PRDM zipper kit. Eproms, Eeproms, and more. Stand alone, RS232, or parallel. For information send to: **ZAPPER**, 6910 Patterson, Caledonia, MI 49316.

JERROLD Tri-mode add-on circuit. PC board layout, artwork, parts list and instructions for interface in SB-3 or DIC type units - \$12.00. **ARUS ELECTRONICS**, PO Box 662, Chappaqua, NY 10514.

STEREO TV ADAPTER KIT Easily converts any TV/VCR to receive the new stereo TV sound. Contains all parts PCB and instructions to build a quality stereo decoder. For additional information send SASE to **SOKOLOWSKI**, Box 150, Elmont, NY 11003.

THIS IS A REGULAR CLASSIFIED AD WITH A TINT BACKGROUND. To have your ad appear like this one, there is a 25% premium.

THIS IS A BOLDFACE EXPANDED AD. If you like this format, request it. Your cost is \$3.75 per word, plus 45% for the boldface and tint background.

MASTERCARD AND VISA are now accepted for payment of your advertising. Simply complete the form on the first page of the Market Center and we will bill.

cable tv

DESCRAMBLER PARTS!

We stock the exact parts. PC board and AC adaptor for Radio Electronics February 1984 article on building your own Cable TV Descrambler.

- | | | |
|------|--|---------|
| #701 | PARTS PACKAGE | \$29.95 |
| | Includes all the original resistors, capacitors, diodes, transistors, integrated circuits, coils, IF transformers (toko BKAN-K3552AXX) | |
| #702 | PC BOARD | \$12.95 |
| | Original etched & drilled silk-screened PC board used in the article. | |
| #704 | AC ADAPTOR | \$12.95 |
| | Original (14 volts DC @ 285ma) ac adaptor used in the article. | |

SPECIALS

- | | |
|----------------------------------|----------|
| BOTH #701 & #702..... | NOW \$39 |
| ALL THREE #701, #702 & #704..... | NOW \$49 |

Add \$2.50 shipping and handling — \$4.50 for Canadian orders
We also offer quantity discounts on 5 or more units

FREE Reprint of Radio Electronics article (February 1984) on Building Your Own CABLE TV DESCRAMBLER with any purchase of above.

60-CHANNEL
**CABLE
CONVERTER**
WITH INFRARED REMOTE CONTROL



SC-60R CONVERTER \$69.95

Thousands of these converters sold nationally for \$119.95. We offer you the same type of converter for only \$69.95. All converters are sold with Full manufacturer's WARRANTY.

FEATURES

- Full 60 Channel Capability
- Cordless infrared remote control
- Ultra Stable Synthesized Tuning
- Microprocessor controlled PLL
- Works on all TV systems, channel 3 output
- Standard VCR Switch for compatibility with all Cable Systems
- Will work with all types of antenna descramblers

Add \$3.50 Shipping and Handling
\$4.50 on Canadian Orders

**ORDER
TOLL FREE
1-800-227-8529**



inside MA 617-695-8689
VISA, MASTERCARD or C.O.D.



**J & W
ELECTRONICS, INC.**

6 Wilkins Dr., Suite 207
Plainville, MA... 02762

CIRCLE 65 ON FREE INFORMATION CARD

This will be
coming to you
when you
subscribe to
Radio-Electronics

**HELPFUL
CONSTRUCTION
ARTICLES...**

Test Equipment
Hi-Fi Accessories
Telephone Accessories
Music Synthesizers
Computer Equipment
Automotive Equipment
Intruder Alarms-
Home & Car
Video Accessories

**NEWS ON NEW
TECHNOLOGY**

Computers
Microprocessors
Satellite TV
Teletext
Automotive Electronics
Speech Synthesizers
IC Applications

**FASCINATING
"HOW TO DO IT"
ARTICLES...**

Build Your Own
Projects
Make Your Own PC
Boards
Wiring Techniques
Soldering and
Desoldering
Design and Prototyping

Radio-Electronics
TECHNOLOGY - VIDEO - STEREO - COMPUTERS - SERVICE

BUILD THIS SATELLITE TV RECEIVER
Great performance for under \$100

HOW TO COMBAT EMI
Electromagnetic interference
can be stopped!

**DON'T LET HEAT
DESTROY YOUR
PROJECTS**
We'll show you how
to keep things cool

**BUILD R-E's DELUXE
VIDEO TITLER**
For professional-quality videotapes

DIGITAL IC's
How to use multivibrators
in your designs

HOW TO SERVICE CD PLAYERS
A troubleshooting guide

PLUS:
★ New column: Ask R-E ★ **COMPUTER DIGEST**
★ Robotics ★ Service Clinic ★ PC Service
★ Antique Radios ★ State-Of-Solid-State

• **HOW YOU AND THE COMPUTER
CAN BE FRIENDS...**

Getting Started
Programs, Circuit
Design, Games
A/D-D/A interfacing
Peripheral Equipment

• **NEW AUDIO DIMENSIONS
FOR YOUR PLEASURE...**

Noise-Reduction Devices
How to Connect that
Extra Add-On
Hi-Fi Accessories
New Technology

• **TV WONDERS FOR YOUR
FUTURE...**

Latest Receivers and
Circuits
The Home Entertainment
Center
Projection TV
Satellite TV Receivers
Jack Darr's Monthly
Service Clinic
Service Problems and
Solutions

• **REGULAR MONTHLY FEATURES**

DESIGNERS NOTEBOOK
by Robert Grossblatt
HOBBY CORNER
by "Doc" Savage, K4SDS
STATE-OF-SOLID-STATE
by Bob Scott
WHAT'S NEWS, new
products, stereo news
and **NEW IDEAS**, **STEREO
PRODUCTS**, **NEW
COMPUTER PRODUCTS**
FOR HOME/JOB and
MUCH MORE!

Radio-Electronics covers all
aspects of the fast moving
electronics field...featuring
**COMPUTERS • VIDEO • STEREO
TECHNOLOGY • SERVICE
COMMUNICATIONS • PROJECTS**

Get it all!

Subscribe today to Radio-Electronics! Don't miss a single
issue and...see subscription card in back of this issue for big savings.

When you select one of the subscription offers listed on the handy coupon—you'll be
assured of having your copy reserved, even if it sells out on the newsstand. Make sure
you get all the excitement in every issue of Radio-Electronics, every month, by filling in
and mailing your subscription card today.

AUGUST 1986

BUILD A COMPLETE 256K XT SYSTEM—\$717

STATIC RAMS			
2101	256x4	(450ns)	1.95
5101	256x4	(450ns)(CMOS)	3.95
2102L-4	1024x1	(450ns)(L.P.)	.99
2112	256x4	(450ns)	2.99
2114	1024x4	(450ns)	.99
2114L-4	1024x4	(450ns)(L.P.)	1.99
2114L-2	1024x4	(200ns)(L.P.)	1.49
2114L-1B	1024x4	(150ns)(L.P.)	1.99
TMS4044-4	4096x1	(450ns)	1.95
TMM2018-150	2048x8	(150ns)	1.49
TMM2018-100	2048x8	(100ns)	1.99
HMC118-4	2048x8	(200ns)(CMOS)	1.39
HMC118-3	2048x8	(150ns)(CMOS)	1.49
HMC118LP-4	2048x8	(200ns)(CMOS)(L.P.)	1.49
HMC118LP-3	2048x8	(150ns)(CMOS)(L.P.)	1.59
HMC118LP-2	2048x8	(120ns)(CMOS)(L.P.)	2.95
HMC264P-1B	8192x8	(150ns)(CMOS)	3.88
HMC264LP-1B	8192x8	(550ns)(CMOS)(L.P.)	3.15
HMC264LP-12	8192x8	(120ns)(CMOS)(L.P.)	4.89

DYNAMIC RAMS			
4118-280	18384x1	(250ns)	.49
4118-200	16384x1	(200ns)	.99
4118-150	16384x1	(150ns)	.95
4118-120	16384x1	(120ns)	1.49
NK4332	32768x1	(200ns)	0.95
4184-200	65536x1	(200ns)(5v)	1.19
4184-150	65536x1	(150ns)(5v)	1.29
4184-120	65536x1	(120ns)(5v)	1.95
MCM6665	65536x1	(200ns)(5v)	1.95
TMS4184	65536x1	(150ns)(5v)	1.95
4184-REFRESH	65536x1	(150ns)(5v)(REFRESH)	4.95
TMS4418	14384x4	(150ns)(5v)	4.95
41128-150	131072x1	(150ns)(5v)	5.95
TMS4484-1B	65536x4	(150ns)(5v)	4.95
41296-200	262144x1	(200ns)(5v)	2.95
41296-150	262144x1	(150ns)(5v)	2.95

8000			
8035	1.49		
8039	1.95		
8080	2.95		
8085	2.49		
8087.2	169.95		
8087	129.00		
8088	6.95		
8088.2	5.95		
8155	2.45		
8159-2	3.95		
8148	3.95		
8155	19.95		
80288	129.95		
80287	199.95		

8200			
8203	29.95		
8205	3.29		
8212	1.48		
8216	1.45		
8224	2.29		
8227	4.95		
8227-5	5.49		
8230	6.95		
8251	1.89		
8251A	1.89		
8253	1.89		
8253.5	1.95		
8255	1.89		
8255-8	1.89		
8255	1.89		
8255-5	2.29		
8272	4.95		
8278	2.69		
8279	2.95		
8282	3.95		
8284	2.95		
8286	3.95		
8288	4.95		

Z-80			
Z80-CPU 25 MHz 1.69			
Z80A-CPU	1.79		
Z80A-CTC	1.89		
Z80A-DART	5.95		
Z80A-DMA	5.95		
Z80A-PIO	1.89		
Z80A-SIO/0	8.95		
Z80A-SIO/1	5.95		
Z80A-SIO/2	5.95		

4.0 MHz			
8800A	4.95		
8800B	5.95		
8800E	4.95		
88009	8.45		
88021	3.80		
88045	6.79		
88050	3.95		
88053	5.95		
88054	7.99		

6.0 MHz			
Z8000 CPU	3.75		
Z8000-CTC	4.25		
Z8000-PIO	4.25		
Z8000-DART	14.95		
Z8000-SIO/0	12.95		
Z8000-SIO/2	12.95		
Z8017 7100	19.95		

CLOCK CIRCUITS

MM5369	1.95
MM5369-EST	1.95
MM53167	12.95
MM53174	11.95
MM53932	2.95

SOUND CHIPS

76477	3.95
76485	8.95
SS-263	39.95
AY3 8910	12.95
IM6403	12.95
SP1000	39.00

★★★★ HIGH-TECH ★★★★★
NEC V20 UPD70108 \$14.95
 REPLACES 8088 TO SPEED UP IBM PC 10-40%
 • HIGH-SPEED ADDRESS CALCULATION IN HARDWARE
 • PIN COMPATIBLE WITH 8088
 • SUPERSET OF 8088 INSTRUCTION SET
 • LOW POWER CMOS
8MHz V20 UPD70108-8 \$24.95
8MHz V30 UPD70116-8 \$26.95
 ★★★★★ SPOTLIGHT ★★★★★

ORDER TOLL FREE 800-538-5000

VISA MasterCard

EPROMS			
2708	1024x8	(450ns)	3.95
2716	2048x8	(450ns)(5V)	3.49
2718-1	2048x8	(350ns)(5V)	3.95
TMS2832	4096x8	(450ns)(5V)	3.95
2732	4096x8	(450ns)(5V)	3.89
2732A	4096x8	(250ns)(5V)(21V PGM)	3.95
2732A-2	4096x8	(250ns)(5V)(21V PGM)	4.25
27C84	8192x8	(250ns)(5V)(CMOS)	5.95
2784	8192x8	(450ns)(5V)	3.49
2784-250	8192x8	(250ns)(5V)	3.95
2784-200	8192x8	(200ns)(5V)	4.25
MCM68766	8192x8	(350ns)(5V)(24 Pin)	17.95
27128	16384x8	(250ns)(5V)	4.25
27C256	32768x8	(250ns)(5V)(CMOS)	12.95
27256	32768x8	(250ns)(5V)	7.49

5V Single 5 Volt Supply 21V PGM, Program at 21 Volts

SPECTRONICS CORPORATION EPROM ERASERS



Model	Timer	Capacity Chips	Intensity (uW/cm²)	Unit Price
PE-14	NO	8	8,000	\$83.00
PE-14T	YES	8	8,000	\$118.00
PE-24T	YES	12	8,000	\$179.00

8080			
8035	1.49		
8039	1.95		
8080	2.95		
8085	2.49		
8087.2	169.95		
8087	129.00		
8088	6.95		
8088.2	5.95		
8155	2.45		
8159-2	3.95		
8148	3.95		
8155	19.95		
80288	129.95		
80287	199.95		

8200			
8203	29.95		
8205	3.29		
8212	1.48		
8216	1.45		
8224	2.29		
8227	4.95		
8227-5	5.49		
8230	6.95		
8251	1.89		
8251A	1.89		
8253	1.89		
8253.5	1.95		
8255	1.89		
8255-8	1.89		
8255	1.89		
8255-5	2.29		
8272	4.95		
8278	2.69		
8279	2.95		
8282	3.95		
8284	2.95		
8286	3.95		
8288	4.95		

8080			
8035	1.49		
8039	1.95		
8080	2.95		
8085	2.49		
8087.2	169.95		
8087	129.00		
8088	6.95		
8088.2	5.95		
8155	2.45		
8159-2	3.95		
8148	3.95		
8155	19.95		
80288	129.95		
80287	199.95		

8200			
8203	29.95		
8205	3.29		
8212	1.48		
8216	1.45		
8224	2.29		
8227	4.95		
8227-5	5.49		
8230	6.95		
8251	1.89		
8251A	1.89		
8253	1.89		
8253.5	1.95		
8255	1.89		
8255-8	1.89		
8255	1.89		
8255-5	2.29		
8272	4.95		
8278	2.69		
8279	2.95		
8282	3.95		
8284	2.95		
8286	3.95		
8288	4.95		

8080			
8035	1.49		
8039	1.95		
8080	2.95		
8085	2.49		
8087.2	169.95		
8087	129.00		
8088	6.95		
8088.2	5.95		
8155	2.45		
8159-2	3.95		
8148	3.95		
8155	19.95		
80288	129.95		
80287	199.95		

CRITICAL CONTROLLERS			
6845	4.95		
68845	8.95		
6887	11.95		
HD46505SP	6.95		
MC1377	2.95		
8275	26.95		
7225	19.95		
CRT5027	12.95		
CRT5037	9.95		
TMS9918A	19.95		

DISK CONTROLLERS			
1771	4.95		
1791	9.95		
1793	9.95		
1796	12.95		
1797	12.95		
2791	19.95		
2793	19.95		
2795	28.95		
5843	19.95		
8272	4.95		
UPO785	4.95		
W84878	12.95		
MM6877	12.95		
1871	8.95		
2141	9.95		

CRYSTALS			
32,768 KHz	.95		
1.0 MHz	2.95		
1.8432	2.95		
2.0	1.95		
2.097152	1.95		
2.4678	1.95		
3.2768	1.95		
3.579545	1.95		
5.898	1.95		
8.032	1.95		
8.0	1.95		
9.0688	1.95		
8.0	1.95		
8.144	1.95		
8.6636	1.95		
8.0	1.95		
10.0	1.95		
10.738635	1.95		
12.0	1.95		
14.31818	1.95		
15.0	1.95		
18.0	1.95		
17.430	1.95		
18.0	1.95		
18.432	1.95		
20.0	1.95		
22.1184	1.95		
24.0	1.95		
32.0	1.95		

CRYSTAL OSCILLATORS			
1.0MHz	5.95		
2.4678	8.95		
2.0	5.95		
4.0	4.95		
5.0888	4.95		
8.0	4.95		
8.144	4.95		
8.0	4.95		
10.0	4.95		
12.0	4.95		
12.480	4.95		
18.0	4.95		
18.0	4.95		
18.432	4.95		
20.0	4.95		
24.0	4.95		

MISC.			
TMS99531	9.95		
TMS99532	19.95		
ULN2003	7.9		
3242	7.95		
3341	1.95		
MC3480	1.95		
MC3487	8.95		
MC3487	2.95		
11C90	13.95		
2513-001	6.95		
AYS-2378	11.95		
AYS-3600	11.95		

74LS00			
74LS00	.18	74LS165	.89
74LS01	.18		

PARTIAL LISTING ONLY — CALL FOR A FREE CATALOG

CMDS

4001	.15	14419	4.95
4011	.19	14433	14.95
4012	.25	4503	.47
4013	.35	4511	.80
4015	.28	4516	.79
4016	.29	4518	.85
4017	.45	4522	.79
4018	.69	4526	.79
4020	.59	4527	9.95
4021	.89	4529	.79
4024	.49	4529	2.95
4025	.28	4532	1.95
4027	.39	4538	.95
4028	.65	4541	1.29
4035	.69	4553	8.79
4040	.89	4585	.79
4041	.79	4787	12.95
4042	.59	7409	.28
4043	.85	74C14	.85
4044	.69	74C74	.85
4045	1.98	74C83	1.95
4046	.65	74C85	1.49
4047	.89	74C95	.99
4049	.39	74C190	8.75
4050	.39	74C191	2.26
4051	.89	74C181	1.99
4052	.89	74C183	.95
4053	.89	74C184	1.39
4056	2.15	74C192	1.49
4060	.85	74C193	1.49
4086	.39	74C221	1.75
4069	.19	74C240	1.89
4076	.59	74C241	1.89
4077	.29	74C374	1.99
4081	.22	74C504	10.95
4085	.79	74C911	8.95
4086	.35	74C912	8.95
4093	.49	74C927	4.69
4094	2.49	74C927	8.95
14411	8.95	74C928	7.95
14412	8.95	80C97	.95

7400/9000

7400	.19	74167	2.49
7402	.19	74168	1.20
7404	.19	74169	1.35
7406	.29	74161	.95
7407	.29	74153	.95
7408	.24	74164	1.49
7410	.19	74156	.75
7411	.25	74187	.95
7414	.49	74159	1.65
7415	.39	74181	.89
7417	.28	74163	.65
7420	.19	74184	.49
7423	.29	74165	.89
7430	.19	74166	1.00
7432	.29	74179	.89
7438	.25	74177	.75
7442	.49	74178	1.15
7445	.39	74181	2.29
7447	.89	74182	.79
7470	.39	74184	2.00
7473	.34	74191	1.15
7474	.33	74192	.79
7478	.48	74194	.85
7478	.35	74196	.79
7483	.59	74197	.75
7485	.58	74195	.99
7486	.39	74221	1.35
7488	2.15	74246	1.35
7490	.39	74247	1.25
7492	.59	74248	1.85
7493	.35	74249	1.95
7495	.55	74251	.75
7497	3.75	74265	1.35
74100	2.29	74273	1.99
74121	.29	74278	3.11
74123	.49	74367	.65
74125	.48	74368	.65
74141	.65	9368	3.99
74143	8.95	9602	9.99
74144	2.95	9837	2.99
74145	.60	98502	1.95

74500

74500	.29	745163	1.29
74502	.29	745188	3.99
74503	.29	745174	.79
74504	.29	745178	.79
74506	.29	745189	1.95
74508	.25	745189	1.99
74510	.29	745195	1.49
74515	.35	745196	1.49
74530	.29	745197	1.49
74532	.36	745226	3.99
74537	.65	745240	1.49
74538	.69	745241	1.49
74574	.48	745244	1.49
74585	.95	745257	.79
74584	.35	745253	.79
746112	.50	745258	.99
746124	2.75	745280	1.99
746138	.79	745287	1.89
746140	.55	745288	1.69
746181	.79	745299	2.99
745183	.79	745373	1.89
745197	.79	745374	1.49
745188	.95	745471	4.99
745181	1.29	745571	2.99

VOLTAGE REGULATORS

TO-220 CASE

7905T	.49	7905T	.59
7906T	.49	7906T	.59
7912T	.49	7912T	.59
7915T	.49	7915T	.59

TO-3 CASE

7905K	1.39	7905K	1.49
7912K	1.39	7912K	1.49

TO-93 CASE

7906	.49	79105	.89
7917	.49	79112	1.49

OTHER VOLTAGE REGS

LM123R	SV	3A	10.3	4.79
LM123K	AA	8A	10.3	3.95
79M05K	SV	8A	10.3	3.95
79M05K	SV	10A	10.3	4.95

LINEAR

TL066	.99	LM733	.99
TL871	.59	LM741	.29
TL072	1.09	LM747	.89
TL074	1.99	LM748	.89
TL081	.59	MC1330	1.89
TL082	.99	MC1350	1.19
TL084	1.49	MC1372	9.99
LM301	.34	LM1414	1.89
LM309K	1.28	LM1488	.89
LM311	.59	LM1488	.49
LM311M	.89	LM1488	.49
LM317K	3.49	LM1496	.89
LM317T	.95	LM1912	8.99
LM318	1.49	LM1289	9.99
LM319	1.28	ULN2003	.79
LM320	7.90	KX2204	3.79
LM322	1.65	KX2261	2.99
LM323K	4.79	KX2260	1.99
LM324	.49	MP02907	1.99
LM331	3.95	LM2917	1.99
LM334	1.19	CA3046	.89
LM335	1.40	CA3081	.99
LM336	1.75	CA3082	.99
LM337K	3.95	CA3086	.89
LM338K	3.95	CA3089	1.99
LM375	.89	CA3130E	.99
LM347	7.90	CA3144	1.29
LM350T	1.60	CA3160	1.19
LF353	.59	MC3470	1.99
LF356	.99	MC3460	8.99
LF357	.99	MC3487	2.99
LM358	.59	LM3900	.49
LM380	.89	LM3909	.99
LM383	1.99	LM3911	2.75
LM395	1.95	LM3918	2.39
LM393	.89	MC4024	3.49
LM394H	4.50	MC4044	3.99
TL494	4.20	CA4138	1.25
TL497	3.25	CA4558	.69
NE555	.29	LM13600	1.89
NE556	.48	75107	1.49
NE558	1.29	75119	1.99
NE561	1.95	75150	1.99
LM565	.95	79154	1.99
LM586	1.49	75168	1.25
LM567	.79	75189	1.29
NE570	2.95	75451	.39
NE590	2.50	75482	.39
NE592	.98	75453	.39
LM710	.95	75477	1.29
LM723	.49	75482	.79

IC SOCKETS

8 PIN ST	.11	10
14 PIN ST	.11	99
16 PIN ST	1.60	10
18 PIN ST	.18	13
20 PIN ST	.18	15
22 PIN ST	.19	12
24 PIN ST	.20	15
26 PIN ST	.22	18
40 PIN ST	.95	22
84 PIN ST	9.95	14

ST. SOLIDRYAL

8 PIN WW	.89	89
14 PIN WW	.89	89
16 PIN WW	.89	89
18 PIN WW	.99	90
20 PIN WW	1.09	90
22 PIN WW	1.29	1.99
24 PIN WW	1.49	1.39
26 PIN WW	1.69	1.49
40 PIN WW	1.99	1.89

WW WIREWRAP

16 PIN ZIF	4.99	CALL
24 PIN ZIF	5.95	CALL
26 PIN ZIF	8.95	CALL
40 PIN ZIF	9.95	CALL

ZIF-TEXT TOOL
(2) NO INSERTION FORCE

DATA ACQ INTERFACE

ADC0800	15.55	8726	1.79
ADC0804	3.49	8728	1.79
ADC0809	4.49	8731	.89
ADC0818	14.95	8736	.89
ADC0817	9.95	8737	.99
ADC0831	8.95	8738	.89
OAC0800	4.49	DM8131	2.95
OAC0806	1.95	DP8104	2.79
OAC0808	2.95	DS8833	2.75
OAC1020	8.75	DS8835	1.95
OAC1022	5.95	DS8836	.99
MC14081.8	2.95	DS8837	1.99

EDGECARD CONNECTORS

100 PIN ST	8-100	.125	3.95
100 PIN WW	8-100	.125	4.95
82 PIN ST	8-100	1.00	2.95
82 PIN ST	APPLE	1.00	2.95
44 PIN ST	STD	.156	1.89
44 PIN WW	STD	.156	4.95

36 PIN CENTRONICS

ICD1636	RIBBON CABLE	6.95
CEN36	SOLDER CUP	4.99
ICD1636/F	FEMALE	
ICD1636/R	RIBBON CABLE	7.95
CEN36PC	RT ANGLE PC MOUNT	6.95

INTERSIL

ICL7106	9.95
ICL7107	12.95
ICL7388	2.95
ICL8038	4.95
KCM7207A	5.95
KCM7208	15.95

DIP CONNECTORS

DESCRIPTION	ORDER BY	CONTACTS											
		8	14	18	19	20	22	24	25	40			
HIGH RELIABILITY TOOLED ST IC SOCKETS	AUGATxST	.82	.79	.89	1.09	1.29	1.49	1.99	2.49				
HIGH RELIABILITY TOOLED WW IC SOCKETS	AUGATxWW	1.30	1.80	2.10	2.40	2.80	2.90	3.15	3.70	8.40			
COMPONENT CARRIERS (DIP HEADERS)	ICCxx	.49	.59	.69	.79	.89	.99	1.09	1.49				
RIBBON CABLE DIP PLUGS (IC)	IDPxx	---	.95	.96	---	---	---	1.75	---	2.95			

FOR ORDERING INSTRUCTIONS SEE D-SUBMINIATURE BELOW

D-SUBMINIATURE

DESCRIPTION	ORDER BY	CONTACTS					
		9	18	19	25	37	50
SOLDER CUP	MALE	DBxxP	.82	.90	1.29	1.29	3.48
	FEMALE	DBxxS	.96	1.19	1.60	1.50	3.32
RIGHT ANGLE PC SOLDER	MALE	DBxxPR	1.20	1.49	---	1.95	2.65
	FEMALE	DBxxSR	9.26	1.56	---	2.00	2.79
WIRE WRAP	MALE	DBxxPWW	1.89	2.95	---	3.89	5.90
	FEMALE	DBxxSww	2.76	4.27	---	6.84	9.79
IOC	MALE	IDxxP	2.76	2.96	---	3.99	9.79
	FEMALE	IDxxS	2.92	3.20	---	4.33	6.79
HOODS	METAL	MH00Dxx	1.76	1.25	1.39	5.30	---
	GREY	HOODxx	.65	.88	---	.88	.79

ORDERING INSTRUCTIONS: INSERT THE NUMBER OF CONTACTS IN THE POSITION MARKED "x" OF THE "ORDER BY" PART NUMBER LISTED
EXAMPLE: A 15 PIN RIGHT ANGLE MALE PC SOLDER WOULD BE DB15PR

MOUNTING HARDWARE \$1.00

IOC CONNECTORS

DESCRIPTION	ORDER BY	CONTACTS					
		10	20	26	34	40	50
SOLDER HEADER	IDMxxS	.82	1.29	1.68	2.20	2.99	3.24
RIGHT ANGLE SOLDER HEADER	IDMxxSR	.85	1.26	1.76	2.31	2.72	3.39
WW HEADER	IDMxxW	1.94	2.99	3.84	4.90	6.28	6.63
RIGHT ANGLE WW HEADER	IDMxxWR	2.05	3.29	4.33	4.46	4.80	7.30
RIBBON HEADER SOCKET	IDxx	.79	.89	1.39	1.59	1.99	2.25
RIBBON HEADER	IDMxx	---	6.50	8.26	7.00	7.80	8.90
RIBBON EDGE CARD	IDExx	1.75	2.25	3.86	3.79	3.89	3.99

FOR ORDERING INSTRUCTIONS SEE D-SUBMINIATURE ABOVE

HARD TO FIND "SNAPABLE" HEADERS

CAN BE SNAPPED APART TO MAKE ANY SIZE HEADER. ALL WITH .1" CENTERS

1x40	STRAIGHT LEAD	.99
1x40	RIGHT ANGLE	1.49
2x40	STRAIGHT LEAD	2.89
2x40	RIGHT ANGLE	2.99

SHORTING BLOCKS

GOLD CONTACTS SPACED AT 1" CENTERS

5/\$1.00

Dear Mr. Rose:

I feel compelled to commend you and your people for the pleasant, polite, willingness to help and professional attitude you have displayed in these times it is indeed refreshing to deal with a company whose staff consists of people of this caliber. My friends and associates will most certainly be doing business with you again.

Sincerely, Nicholas Chabra

DIODES/OPTO/TRANSISTORS

1N751	.28	4N28	.69
1N753	.25	4N27	.69
1N4148	26/1.00	4N28	.69
1N4004	10/1.00	4N33	.89
1N5402	.25	4N37	

ORDER TOLL FREE 800-538-5000

BARGAIN HUNTERS CORNER ATTENTION PC USERS!

10 MB HARD DISK SYSTEM \$349

- SHOCK MOUNTED FOR 80 Gs— IDEAL FOR PORTABLES!
- MMI MODEL MM212, 2 1/2" HEIGHT, 7" ACCESS
- INCLUDES CONTROLLER, CABLES & INSTRUCTIONS FOR IBM

WIRELESS KEYBOARD \$129

- MADE BY CHERRY FOR IBM PC & XT
- OPERATES UP TO 40 FEET FROM COMPUTER
- INFRARED RECEIVER FOR PC XT INCLUDED

HURRY—QUANTITIES ARE LIMITED!
SPECIALS END 8/31/86

PAGE WIRE WRAP WIRE PRECUT ASSORTMENT IN ASSORTED COLORS \$27.50

1000m 5.5", 6.0", 6.5", 7.0"
250m 2.0", 4.5", 5.0"
500m 3.0", 3.5", 4.0"

SPOOLS

100 feet \$4.20 200 feet \$7.25
500 feet \$13.25 1000 feet \$21.95

Please specify color:
Blue, Black, Yellow or Red

EMI FILTER \$4.95

- MANUFACTURED BY CORCOM
- LOW COST
- FITS LC-HP BELOW
- 6 AMP 120, 240 VOLT



8 FOOT LINE CORDS

LC-2 2 CONDUCTOR .39
LC-3 3 CONDUCTOR .99
LC-HP 3 CONDUCTOR W STD FEMALE SOCKET 1.49

MUFFIN FANS

3.15" 50 ROTRON 14.95
3.83" 50 ETRI 14.95
3.18" 50 MASUSHITA 18.95

WIRE WRAP PROTOTYPE CARDS FR-4 EPOXY GLASS LAMINATE WITH GOLD PLATED EDGE-CARD FINGERS



IBM-PR2

IBM

BOTH CARDS HAVE SILK SCREENED LEGENDS AND INCLUDES MOUNTING BRACKET

IBM-PR1 WITH +5V AND GROUND PLANE \$27.95
IBM-PR2 AS ABOVE WITH DECODING LAYOUT \$29.95

S-100

P100-1 BARE - NO FOIL PADS \$15.15
P100-2 HORIZONTAL BUS \$21.80
P100-3 VERTICAL BUS \$21.80
P100-4 SINGLE FOIL PADS PER HOLE \$22.75

APPLE

P500-1 BARE - NO FOIL PADS \$15.15
P500-2 HORIZONTAL BUS \$22.75
P500-4 SINGLE FOIL PADS PER HOLE \$21.80
7060-45 FOR APPLE IIa AUX SLOT \$30.00

SOCKET-WRAP I.D.™

- SLIPS OVER WIRE WRAP PINS
 - IDENTIFIES PIN NUMBERS ON WRAP SIDE OF BOARD
 - CAN WRITE ON PLASTIC, SUCH AS IC#
- | PINS | PART# | PCIL OF | PRICE |
|------|-----------|---------|-------|
| 8 | IDWRAP 08 | 10 | 1.95 |
| 14 | IDWRAP 14 | 10 | 1.95 |
| 18 | IDWRAP 18 | 10 | 1.95 |
| 18 | IDWRAP 18 | 5 | 1.95 |
| 20 | IDWRAP 20 | 8 | 1.95 |
| 22 | IDWRAP 22 | 8 | 1.95 |
| 24 | IDWRAP 24 | 5 | 1.95 |
| 28 | IDWRAP 28 | 5 | 1.95 |
| 40 | IDWRAP 40 | 8 | 1.95 |
- PLEASE ORDER BY NUMBER OF PACKAGES (PKG. OF)



FRAME STYLE TRANSFORMERS

12.6V AC CT 2 AMP 5.95
12.6V AC CT 4 AMP 7.95
12.6V AC CT 8 AMP 10.95
25.2V AC CT 2 AMP 7.95

25 PIN D-SUB BENDER CHANGERS \$7.95



SWITCHING POWER SUPPLIES

PS-IBM \$89.95

- FOR IBM PC-XT COMPATIBLE
- 136 WATTS
- +5V @ 15A, -12V @ 4.2A
- +5V @ 5A, -12V @ 5A
- ONE YEAR WARRANTY



PS-IBM-150 \$99.95

- FOR IBM PC-XT COMPATIBLE
- 150 WATTS
- +12V @ 2.2A, +5V @ 16A
- +12V @ 3A, +5V @ 5A
- ONE YEAR WARRANTY



PS-130 \$99.95

- 130 WATTS
- SWITCH ON REAR
- FOR USE IN OTHER IBM TYPE MACHINES
- 90 DAY WARRANTY



PS-A \$49.95

- USE TO POWER APPLE TYPE SYSTEMS
- +5V @ 4A, -12V @ 2.5A
- +5V @ 5A, -12V @ 5A
- APPLE POWER CONNECTOR



PS-SPL200 \$49.95

- +5V @ 26A, -12V @ 3.5A
- +5V @ 1A, -12V @ 1A
- UL APPROVED
- ALUMINUM ENCLDURE

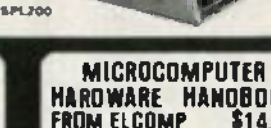

CAPACITORS

TANTALUM			
1.0µf	15V	36	47µf 35V 48
6.8	15V	.70	1.0 35V 45
10	15V	.80	2.2 35V 65
22	15V	1.35	4.7 35V 85
22	35V	40	10 35V 100

DISC			
10µf	50V	05	50µf 50V 05
22	50V	08	.001µf 50V 05
27	50V	04	.0022 50V 05
33	50V	.08	.005 50V 05
47	50V	04	.81 50V 07
68	50V	05	.02 50V 07
100	50V	05	.05 50V 07
220	50V	05	.1 12V .10
560	50V	05	.1 50V .12

MONOLITHIC			
01µf	50V	.14	.1µf 50V .18
.047µf	50V	.15	47µf 50V .28

ELECTROLYTIC			
RADIAL			
1µf	25V	.14	1µf 50V .14
2.2	35V	.18	10 50V .18
4.7	50V	.16	22 15V .14
10	50V	.18	47 50V 20
47	35V	.18	100 35V 25
100	18V	.18	220 25V .28
220	15V	20	470 50V .50
470	25V	30	1000 18V .80
2200	18V	.70	2200 18V .70
4700	25V	1.45	4700 18V 1.25

DATASE EPROM ERASER \$34.95

- ERASES 2 IN 10 MINUTES
- COMPACT, NO DRAWER
- THIN METAL SHUTTER PREVENTS UV LIGHT FROM ESCAPING



1/4 WATT RESISTORS

5% CARBON FILM ALL STANDARD VALUES FROM 1 OHM TO 10 MEG OHM

10 PCS	same value	05	100 PCS	same value	.82
50 PCS	same value	.025	1000 PCS	same value	.818

RESISTOR NETWORKS

SIP	10 PIN	9 RESISTOR	.69
SIP	8 PIN	7 RESISTOR	.59
DIP	16 PIN	8 RESISTOR	1.09
DIP	16 PIN	15 RESISTOR	1.09
DIP	14 PIN	7 RESISTOR	.99
DIP	14 PIN	13 RESISTOR	.99

SPECIALS ON BYPASS CAPACITORS

.01 µf CERAMIC DISC 100/\$5.00
.01 µf MONDLITHIC 100/\$10.00
.1 µf CERAMIC DISC 100/\$6.50
.1 µf MONDLITHIC 100/\$12.50

WISH SOLDERLESS BREADBOARDS

PART NUMBER	DIMENSIONS	DISTRIBUTION STRIPS	TIE POINTS	TERMINAL STRIPS	TIE POINTS	BINDING POSTS	PRICE
WBU-D	3.94 x 6.50"	1	100	2.95
WBU-T	1.38 x 6.50"	1	630	...	6.95
WBU-204-3	3.94 x 8.45"	1	100	2	1260	2	17.95
WBU-204	5.13 x 8.45"	4	400	2	1260	3	24.95
WBU-206	6.88 x 9.06"	5	500	2	1890	4	29.95
WBU-208	8.25 x 9.45"	7	700	4	2520	4	39.95



LITHIUM BATTERY AS USED IN CLOCK CIRCUITS



3 VOLT BATTERY \$3.95
BATTERY HOLDER \$1.49

NEW EDITION!

1986 IC MASTER
THE INDUSTRY STANDARD
\$129.95

VISIT OUR RETAIL STORE LOCATED AT 1256 SOUTH BASCOM AVENUE IN SAN JOSE

JDR Microdevices

1224 S. Bascom Avenue, San Jose, CA 95128
Toll Free 800-538-5000 • (408) 995-5430
FAX (408) 275-8415 • Telex 171-110

HOURS: M-W-F, 9-6 TU-TH, 9-9 SAT, 9-5

PLEASE USE YOUR CUSTOMER NUMBER WHEN ORDERING

TERMS: Minimum order \$10.00. For shipping and handling include \$3.50 for UPS Ground and \$3.50 for UPS Air. Orders over 1 lb. and foreign orders may require additional shipping charges - please contact our sales department for the amount. CA residents must include applicable sales tax. All merchandise is warranted for 90 days unless otherwise stated. Prices are subject to change without notice. We are not responsible for typographical errors. We reserve the right to limit quantities and to substitute manufacturer. All merchandise subject to prior sale.

© COPYRIGHT 1986 JDR MICRODEVICES

THE JDR MICRODEVICES LOGO IS A REGISTERED TRADEMARK OF JDR MICRODEVICES. JDR INSTRUMENTS AND JDR MICRODEVICES ARE TRADEMARKS OF JDR MICRODEVICES. IBM IS A TRADEMARK OF INTERNATIONAL BUSINESS MACHINES. APPLE IS A TRADEMARK OF APPLE COMPUTER.

CIRCLE 180 ON FREE INFORMATION CARD

PARTIAL LISTING ONLY — CALL FOR A FREE CATALOG

DISK DRIVES FOR APPLE COMPUTERS

AP-150 \$89.95

- 1/2 HT. DIRECT DRIVE
- 100% APPLE COMPATIBLE
- SIX MONTH WARRANTY



BAL-500 \$129.95

- TEAC MECHANISM, DIRECT DRIVE
- 100% APPLE COMPATIBLE
- FULL ONE YEAR WARRANTY



AP-135 \$129.95

- FULL HT SHUGART MECHANISM
- DIRECT REPLACEMENT FOR APPLE DISK II
- SIX MONTH WARRANTY



DOUBLE SIDED!

MAC535 \$249.95

- 3.5" ADD-ON DISK DRIVE
- 100% MACINTOSH COMPATIBLE
- DOUBLE SIDED 500K BYTE STORAGE
- HIGH RELIABILITY DRIVE
- HAS AUTO-EJECT MECHANISM
- FULL ONE YEAR WARRANTY



AD-3C \$139.95

- 100% APPLE IIc COMPATIBLE
- READY TO PLUG IN, W/ SHIELDED CABLE & MOLDED 15 PIN CONNECTOR
- FAST, RELIABLE SUMINE DIRECT DRIVE
- SIX MONTH WARRANTY



DISK DRIVE ACCESSORIES
FDD CONTROLLER CARD \$49.95
IIc ADAPTOR CABLE \$19.95
ADAPTS STANDARD APPLE DRIVES FOR USE WITH APPLE IIc

KB-1000 \$79.95

- CASE WITH KEYBOARD FOR APPLE TYPE MOTHERBOARD
- USER DEFINED FUNCTION KEYS
- NUMERIC KEYPAD WITH CURSOR CONTROL
- CAPS LOCK • AUTO REPEAT



KEYBOARD-AP \$49.95

- REPLACEMENT FOR APPLE II KEYBOARD
- CAPS LOCK KEY, AUTO-REPEAT
- ONE KEY ENTRY OF BASIC OR CP/M COMMANDS



EXTENDER CARDS

- IBM-PC \$45.00
- IBM-AT \$68.00
- APPLE IIc \$45.00
- APPLE IIe \$45.00
- MULTIBUS \$86.00

APPLE COMPATIBLE INTERFACE CARDS

EPROM PROGRAMMER \$59.95

MODEL RP525

- DUPLICATE OR BURN ANY STANDARD 27xx SERIES EPROM
- EASY TO USE MENU-DRIVEN SOFTWARE IS INCLUDED
- MENU SELECTION FOR 2716, 2732, 2732A, 2764 AND 27128
- HIGH SPEED WRITE ALGORITHM
- LED INDICATORS FOR ACTIVITY
- NO EXTERNAL POWER SUPPLY NEEDED
- ONE YEAR WARRANTY

16K RAMCARD \$39.95

- FULL TWO YEAR WARRANTY
- EXPAND YOUR 48K APPLE TO 64K
- USE IN PLACE OF APPLE LANGUAGE CARD
- MAKE PC CARD W/ INSTRUCTIONS \$8.95

IC TEST CARD \$99.95

- QUICKLY TESTS MANY COMMON ICs
- DISPLAYS PASS OR FAIL
- ONE YEAR WARRANTY
- TESTS 4000 SERIES CMOS, 74HC SERIES CMOS, 7400, 74LS, 74L, 74H & 74S

300B MODEM \$49.95

- INCLUDES ASCII PRO-EZ SOFTWARE



JOYSTICK CD-401 \$7.95

- FOR ATARI 400, 800, 2600, VIC 20/64 AND APPLE IIc

DISKFILE

- HOLDS 70 5 1/4" DISKETTES



3.5" DISKFILE HOLDS 40 \$9.95

POWER STRIP

- UL APPROVED
- 15A CIRCUIT BREAKER



3-WAY SWITCH BOXES

- SERIAL OR PARALLEL
- CONNECTS 3 PRINTERS TO ONE COMPUTER OR VICE VERSA
- ALL LINE SWITCHES
- HIGH QUALITY ROTARY SWITCH MOUNTED ON PCB
- GOLD CONTACTS
- STURDY METAL ENCLOSURE

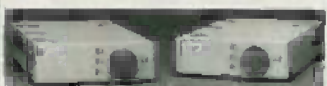

SWITCH-3P CENTRONICS PARALLEL \$99.95

SWITCH-3S RS232 SERIAL \$99.95

PRINTER BUFFERS

- FREES COMPUTER FOR OTHER TASKS WHILE PRINTING LONG DOCUMENTS
- STAND-ALONE DESIGN, WORKS WITH ANY COMPUTER OR PRINTER
- ALL MODELS FEATURE PRINT PAUSE MEMORY CHECK, GRAPHICS CAPABILITY

SP120P PARALLEL \$139.95

- 64K UPGRADABLE TO 256K
- LED INDICATOR SHOWS VOLUME OF DATA IN BUFFER

SP120S RS232 SERIAL \$159.95

- 64K UPGRADABLE TO 256K
- 4 SELECTABLE BAUD RATES, FROM 600 - 19,200B

SP110P PARALLEL \$249.95

- 64K UPGRADABLE TO 512K
- SPOOLS OUTPUT OF UP TO 3 COMPUTERS
- LED BARGRAPH DISPLAYS AMOUNT OF DATA IN BUFFER
- RESET FUNCTION CLEARS DATA IN BUFFER
- REPEAT FUNCTION CAN PRODUCE MULTIPLE COPIES OF A DOCUMENT



SP120 SP110

NASHUA DISKETTES DEALS

5 1/4" SOFT SECTOR DS/DD WITH HUB RINGS

\$9.90 **69c ea** **59c ea**

BOX OF 10 BULK QTY 50 BULK QTY 250

NASHUA DISKETTES WERE JUDGED TO HAVE THE HIGHEST POLISH AND RECORDED AMPLITUDE OF ANY DISKETTES TESTED ACCORDING TO "COMPARING FLOPPY DISKS", BYTE 8/84

DISKETTES NASHUA 5 1/4"

N-MD2F	DS/DD SOFT	\$9.90
N-MD2P	DS/QUAD SOFT	\$34.95
N-MD2H	DS/HD FOR AT	\$49.95

NASHUA 8"

N-F01	SS/DD SOFT	\$27.95
N-F02D	DS/DD SOFT	\$34.95

NASHUA 3.5"

N-3.5SS	3.5" SS/DD FOR MAC	\$32.95
---------	--------------------	---------

VERBATIM 5 1/4"

V-MD1D	SS/DD SOFT	\$23.95
V-MD2D	DS/DD SOFT	\$29.95
V-MD110D	SS/DD TO SECTOR HARD	\$23.95

Sakata 120 CPS DOT MATRIX PRINTER



MODEL SP-1200 \$169.95

- EPSON/IBM COMPATIBLE
- 9-WIRE PRINTHEAD
- 120 CPS-BIDIRECTIONAL, 80 COL
- FRICTION AND TRACTOR FEED
- PROPORTIONAL SPACING
- CENTRONICS PARALLEL INTERFACE
- 8 CHARACTER SETS AND GRAPHICS

6 FOOT IBM PRINTER CABLE \$9.95

REPLACEMENT RIBBON CARTRIDGE \$11.95

5 1/4" FLOPPY DISK DRIVES

TEAC FD-55E 1/2 HT DS/DD FOR IBM	\$109.95
TEAC FD-55F 1/2 HT DS/QUAD FOR IBM	\$124.95
TEAC FD-55GV 1/2 HT DS/HD FOR IBM AT	\$154.95
TANDON TM100-2 DS/DD FOR IBM	\$99.95
TANDON TM50-2 1/2 HT DS/DD FOR IBM	\$85.95
NPI-842 DS/DD FOR IBM	\$89.95
QUME Q-142 1/2 HT DS/DD FOR IBM	\$79.95

8" FLOPPY DISK DRIVES

FD 100-8 SS/DD (5A-80) EOL/IV	\$119.00
FD 200-8 DS/DD (5A/85) R EOL/IV	\$159.00

DISK DRIVE ACCESSORIES

TEAC SPECIFICATION MANUAL	\$5.00
TEAC MAINTENANCE MANUAL	\$25.00
1/2 HT MOUNTING HARDWARE	\$2.50
MOUNTING RAILS FOR IBM AT	\$2.50
1/2" POWER CABLE FOR 5 1/4" FDDs	\$2.50
5/8" FDD POWER CONNECTORS	\$1.19



TEAC FD-55 TANDON TM100-2

DISK DRIVE ENCLOSURES

CAB-APPLE	APPLE TYPE CABINET W/OUT POWER SUPPLY	\$24.95
CAB-1FH5	FULL HT 5 1/4" BEIGE CABINET W/ POWER SUPPLY	\$69.95
CAB-2SV5	DUAL 5 1/4" SLIMLINE 5 1/4" CABINET W/ POWER SUPPLY	\$49.95
CAB-2SV9	VERTICAL DUAL 5 1/4" SLIMLINE 5 1/4" CABINET W/ POWER SUPPLY	\$209.95
CAB-2FH9	HORIZONTAL DUAL FULL HT 5 1/4" CABINET W/ POWER SUPPLY	\$219.95



CAB-2SV5 CAB-1FH5

TEST EQUIPMENT FROM JDR INSTRUMENTS

DIGITAL MULTIMETER PEN DPM-1000 \$54.95

- AUTO RANGING, POLARITY AND DECIMAL!
- LARGE 3.5 DIGIT DISPLAY
- DATA HOLD SWITCH FREEZES READING
- FAST, AUDIBLE CONTINUITY TEST
- LOW BATTERY INDICATOR
- OVERLOAD PROTECTION

20MHZ DUAL TRACE OSCILLOSCOPE MODEL 2000 \$389.00

35MHZ DUAL TRACE OSCILLOSCOPE MODEL 3500 \$549.00

FOR MORE INFORMATION ON THE OSCILLOSCOPES, CALL US FOR FREE PRODUCT BRIEF

CALL FOR VOLUME QUOTES © COPYRIGHT 1986 JDR MICRODEVICES

CIRCLE 181 ON FREE INFORMATION CARD

BUILD A COMPLETE 256K XT SYSTEM—\$717

SEAGATE ST-225 20MB HARD DISK SYSTEM

INCLUDES HALF LENGTH HD CONTROLLER, CABLES, MOUNTING HARDWARE AND INSTRUCTIONS. ALL DRIVES ARE PRE-TESTED AND COME WITH A ONE YEAR WARRANTY.

\$449.00

XT COMPATIBLE MOTHERBOARD

\$159.95

- 4.77 MHz 8088 CPU, OPTIONAL 8087 CO-PROCESSOR
 - 8 EXPANSION SLOTS
 - 0K RAM INSTALLED, EXPANDABLE TO 640K ON-BOARD MEMORY
 - ALL ICs SOCKETED HIGHEST QUALITY PC BOARD
 - ACCEPTS 2784 OR 27128 ROMs
- PRO-BIOS \$29.95**



IBM COMPATIBLE INTERFACE CARDS

ALL WITH A ONE YEAR WARRANTY

MULTI I/O FLOPPY CARD \$129.95

PERFECT FOR THE 840K MOTHERBOARD



- 2 DRIVE 1 FLOPPY DISK CONTROLLER
- 1 RS232 SERIAL PORT: OPTIONAL 2nd SERIAL PORT
- PARALLEL PRINTER PORT
- GAME PORT
- CLOCK/CALENDAR
- SOFTWARE CLOCK UTILITIES
- RAMDISK SPOOLER
- OPTIONAL SERIAL PORT \$15.00

MULTIFUNCTION CARD \$119.95

ALL THE FEATURES OF AST'S 6 PACK PLUS AT HALF THE PRICE



- CLOCK CALENDAR
- 0 384K RAM
- SERIAL PORT
- PARALLEL PORT
- GAME PORT
- SOFTWARE INCLUDED
- PRINTER CABLE \$9.95
- 64K RAM UPGRADE \$9.95/10.71

COLOR GRAPHICS ADAPTOR \$99.95

FULLY COMPATIBLE WITH IBM COLOR CARD



- 4 VIDEO INTERFACES: RGB, COMPOSITE COLOR, HI-RES, COMPOSITE MONOCHROME
- CONNECTOR FOR RF MODULATOR
- COLOR GRAPHICS MODE: 320 x 200
- MONO GRAPHICS MODE: 640 x 200
- LIGHT PEN INTERFACE

MONOCHROME GRAPHICS CARD \$119.95

FULLY COMPATIBLE WITH IBM MONOCHROME ADAPTOR & HERCULES GRAPHICS



- LOTUS COMPATIBLE
- TEXT MODE: 80 x 25
- GRAPHICS MODE: 720 x 348
- PARALLEL PRINTER INTERFACE
- OPTIONAL SERIAL PORT \$19.95

MONOCHROME ADAPTOR \$49.95

ANOTHER FANTASTIC VALUE FROM JDR!

- IBM COMPATIBLE TTL OUTPUT
 - 720 x 350 PIXEL DISPLAY
- PLEASE NOTE: THIS CARD WILL NOT RUN LOTUS GRAPHICS AND DOES NOT INCLUDE A PARALLEL PORT

FLOPPY DISK DRIVE ADAPTOR \$49.95



- INTERFACES UP TO 4 STANDARD FDDs TO IBM PC OR COMPATIBLES
- INCLUDES CABLE FOR TWO INTERNAL DRIVES
- STANDARD DB37 FOR EXTERNAL DRIVES
- RUNS QUAD DENSITY DRIVES WHEN USED WITH JFORMAT

EASYDATA 1200 BAUD MODEM FOR IBM

INCLUDES PC TALK III COMMUNICATIONS SOFTWARE

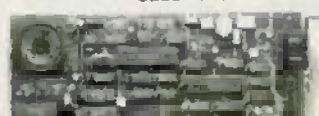

- NEW 10 INCH CARD
- Hayes COMPATIBLE
- AUTO DIAL / AUTO ANSWER
- AUTO RE DIAL ON BUSY
- INCLUDES SERIAL PORT
- ONE YEAR WARRANTY

\$169.95

CRT MONITORS FOR ALL APPLICATIONS



LUXOR HI-RES RGB MONITOR

MODEL 190-8570

- DIGITAL RGB IBM COMPATIBLE
- 14" SCREEN
- 16 TRUE COLORS
- 75 MHz BANDWIDTH
- RESOLUTION > 840 x 282
- 31mm DOT PITCH
- CABLE FOR IBM PC INCLUDED

\$299.95



SAKATA COMPOSITE COLOR

MODEL SC-100

- TOP RATED FOR APPLE
- 13" COMPOSITE VIDEO
- RESOLUTION 280H x 300V
- INTERNAL AUDIO AMP
- ONE YEAR WARRANTY

\$169.95



CENTER SYSTEMS MONOCHROME

MODEL KLM-1217

- IBM COMPATIBLE TTL INPUT
- 12" NON GLARE SCREEN
- P39 GREEN PHOSPHORUS
- VERY HIGH RESOLUTION
- 26 MHz BANDWIDTH
- 1100 LINE S CENTER

AMBI version \$100.00

\$99.95

BUILD YOUR OWN 256K XT COMPATIBLE SYSTEM

- XT MOTHERBOARD \$159.95
- PRO-BIOS \$29.95
- 256K RAM \$26.55
- 130 WATT POWER SUPPLY \$89.95
- FLIP-TOP CASE \$49.95
- OKM-2000 KEYBOARD \$79.95
- 1/2 HEIGHT QUME DRIVE \$79.95
- FLOPPY DISK CONTROLLER \$49.95
- MONOCHROME ADAPTOR \$49.95
- MONOCHROME MONITOR \$99.95

TOTAL: \$716.10

MONITOR STAND



TILTS AND SWIVELS
ONLY \$12.95

IBM PRINTER CABLE



• DIGS TO CENTRONICS SHIELDED CABLE
\$9.95

IBM STYLE COMPUTER CASE

AN ATTRACTIVE STEEL CASE WITH A HINGED LID FITS THE POPULAR PC/XT COMPATIBLE MOTHERBOARDS

- SWITCH CUT-OUT ON SIDE FOR PC/XT STYLE POWER SUPPLY
- CUT OUT FOR 8 EXPANSION SLOTS
- ALL HARDWARE INCLUDED

\$49.95



IBM COMPATIBLE KEYBOARDS

OKM-2000 \$79.95

IBM-5151 \$99.95



- "160" STYLE KEYBOARD
- FULLY IBM COMPATIBLE
- LED STATUS INDICATORS FOR CAPS & NUMBER LOCK
- 83 KEY — SAME LAYOUT AS IBM PC/XT KEYBOARD



- REPLACEMENT FOR KEYTRONICS KB 5151™
- SEPARATE CURSOR & NUMERIC KEYPAD
- CAPS LOCK & NUMBER LOCK INDICATORS
- IMPROVED KEYBOARD LAYOUT

POWER SUPPLY



NOW ONLY \$89.95

- FOR IBM PC-XT COMPATIBLE
- 135 WATTS
- +5V ● 15A, -12V ● 4.2A
- -5V ● 5A, -12V ● 5A

150 WATT MODEL \$99.95

DISK DRIVES

TANON TM50-2

\$89.95

- 1/2 HT DS/DD
- IBM COMPATIBLE
- EXTREMELY QUIET!

TEAC FD-55B	DS/DD	\$109.95
TEAC FD-55F	DS/QUAD	\$124.95
TEAC FD-55B	DS/HD	\$164.00
QUME QT-142	DS/DD	\$79.95
MOUNTING HARDWARE		\$2.95
AT/RAILS		\$4.95

JDR Microdevices

1224 S. Bascom Avenue, San Jose, CA 95128
Toll Free 800-538-5000 • (408) 995-5430 • FAX (408) 275-8415 • Telex 171-110

Radio Shack Parts Place™

THE BUILDER'S STORE! OVER 1000 COMPONENTS IN STOCK

Top-Quality Capacitors

Tantalums. IC pin spacing. 20% tolerance.

µF	WVDC	Cat. No.	Each
0.1	35	272-1432	49
0.47	35	272-1433	49
1.0	35	272-1434	49
2.2	35	272-1435	59
10	16	272-1436	69
22	16	272-1437	89

High-"Q" Ceramics. Moistureproof coating

pF	WVDC	Cat. No.	Pkg. of 2
4.7	50	272-120	39
47	50	272-121	39
100	50	272-123	39
220	50	272-124	39
470	50	272-125	39

µF	WVDC	Cat. No.	Pkg. of 2
001	500	272-126	49
005	500	272-130	49
01	500	272-131	49
05	50	272-134	49
1	50	272-135	49

4000-Series CMOS ICs

With Pin-Out, Specs



Description	Type	Cat. No.	Each
Quad 2-Input NOR Gate	4001	276-2401	79
Quad 2-Input NAND Gate	4011	276-2411	79
Dual Type-D Flip Flop	4013	276-2413	1.19
Decade Counter/Divider	4017	276-2417	1.49
Inverting Hex Buffer	4049	276-2449	99
Quad Bilateral Switch	4066	276-2466	1.19

7400-Series TTL ICs

All Include Pin-Out, Specs



Description	Type	Cat. No.	Each
Quad 2-Input NAND Gate	7400	276-1801	89
Hex Inverter	7404	276-1802	99
Quad 2-Input AND Gate	7408	276-1822	1.29
BCD to 7-Seg. Decoder/Driver	7447	276-1805	1.69
Div. by 2/5 BCD Counter	7490	276-1808	1.19

Power Supply Diodes

Micromini 1-Amp. 30-amp surge.

Type	PIV	Cat. No.	Pkg. of 2
1N4001	50	278-1101	49
1N4003	200	278-1102	59
1N4004	400	278-1103	69
1N4005	800	278-1104	79

3-Amp "Barrel". 200-amp surge.

Type	PIV	Cat. No.	Pkg. of 2
1N5400	50	278-1141	79
1N5402	200	278-1143	89
1N5404	400	278-1144	99

120 VAC Cooling Fan

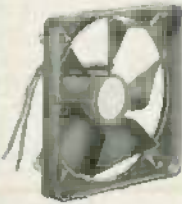

Cools Equipment For Longer Life and Better Performance

This whisper quiet fan delivers up to 65 cubic feet per minute. Features diecast venturi, leads for easy hookup. 11 watts. 4 1/2" x 4 1/2" x 2 1/2". UL recognized. #273-241 14.95

(1) Electronics Books (2) (3)



(1) **Semiconductor Reference Guide.** "Sub" listing plus data on Radio Shack devices. Illustrated. 254 pages. #276-4009 3.99

(2) **Getting Started in Electronics.** By Forrest Mims III. Easy-to-understand "hands on" intro! Learn as you build! 128 pages. #276-5003, 2.49

(3) **Timer IC Mini-Notebook.** By Mims. Learn to use 555/556 timer ICs. 32 pages. #276-5010, 99c
Op Amp Mini-Notebook. By Mims. Over 40 clever circuits using popular op amp ICs such as 741. #276-5011 1.49

NEW! REPLACE-A-CELLS™

Rechargeable Nickel-Cadmiums

The last way to replace defective cells in cordless tools, appliances and telephones



Now you don't have to pay sky-high prices and wait for "exact replacement" battery packs! These new Radio Shack ENERCELLS let you replace only the bad cells and use the good ones. They're available in two popular sizes and have solder tabs for easy connection. Also great for making your own rechargeable battery packs!

Type	Volts	Amp Hour	Cat. No.	Pkg. of 2
Sub C	1.25	1.1	23-190	5.99
AA	1.25	0.45	23-191	3.99

Speech Synthesis Chips



CTS256-AL2 **Text-to-Speech IC.** 40-pin device translates standard ASCII into control data for synthesizer below. With data. #276-1786, 16.95
 SPD256-AL2 **Speech Synthesis IC.** 28-pin MOS LSI device uses a stored program to produce natural speech. With detailed data. #276-1784 12.95

You Rang, Sir?



(4) **12 VDC Electronic Chime.** Melody-synthesizing IC and mini-speaker combo produce a distinctive "ding-dong" output at 75 dB. #273-071 6.95

(5) **Pulsing/Continuous Piezo Buzzer.** Great for alarms, vehicle backup alerts. Screwdriver terms. 90 dB output at 12 VDC, only 10 mA. Operates 4 to 28 VDC. With panel-mounting ring. #273-068 6.95

(6) Transient Protectors (7)

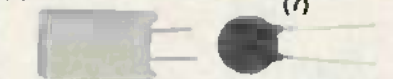

(6) **Gas Discharge Tube.** Fast-response 120 VAC line-spike protector. For use when repetitive surges are expected. #270-811 2.49

(7) **Heavy-Duty MOV.** Diverts AC-line voltage "spikes" before they can damage computers, other sensitive equipment. Easy to install. #276-568 1.69

Subminiature Switches

Low As 1.19



SPDT With 3/16" Lever Actuator. Requires 45 grams to operate. Rated 5 amps at 250 VAC. 3/16" x 1/8" x 3/16". #275-016 1.19

SPST PC-Mount Toggle. Rated 0.3 amp at 125 VAC. Body: 3/16" x 3/16" x 1/8". #275-645 1.49

Resistor Kit Bargains!



(8) **1/2-Watt, 5% tolerance.** 100-piece set includes 13 popular standard values ranging from 10 ohms to one megohm. #271-308 2.79

(9) **Precision Metal-Film.** 1/4-watt, 1% tolerance. 50 pieces with 12 popular standard values ranging from 10 ohms to one megohm. #271-309 2.49

Mini Printed Circuit Pots

Only 49¢ Each

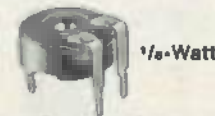

Sealed against noise-causing contaminants.

Ohms	Cat. No.	Each
1k	271-333	49
10k	271-335	49
25k	271-336	49
100k	271-338	49

Handy Test Probe Adapters

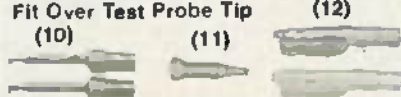

(10) **Mini-Hook Clip Adapters.** Adapt probes for testing on crowded boards. Spring-loaded for positive connection. #270-334 Pair/1.99

(11) **IC Probe Adapter.** Recessed design so you of touch only one IC pin at a time. #270-335, 99c

(12) **Insulated "Gator Clips."** Free hands. 2 1/2" long. One red, one black. #270-354, Pair/1.49

Panel Switch Values

(13) SPST Momentary. Rated 0.5 amp at 125 VAC. 3/16" button. 1/8" mtg hole

Contacts Normally	Cat. No.	Pkg. of 5
Open	275-1547	2.49
Closed	275-1548	2.69

(14) **"Jumbo" Illuminated SPST.** Versatile! Can be wired normally open, or normally closed. Rated 5 amp at 250 VAC. Lamp requires 12 volts. 1/8" mtg hole. #275-678 5.95



Over 1000 items in stock: Binding posts, Books, Breadboards, Buzzers, Capacitors, Chokes, Clips, Connectors, Fuses, Hardware, ICs, Jacks, Knobs, Lamps, Multitesters, PC Boards, Plugs, Rectifiers, Relays, Resistors, Switches, Tools, Transformers, Transistors, Wire, Zener Diodes, more!

Radio Shack®

A DIVISION OF TANDY CORPORATION
 Prices apply at participating Radio Shack stores and dealers

CIRCLE 78 ON FREE INFORMATION CARD

Why Pay Big Blue Prices?

Build your own IBM® PC/XT compatible & SAVE !!



XT Compatible Motherboard

- 100% IBM compatible
- 8088 CPU at 4.78 MHz
- Compatible to 640K
- 4 channel serial ports
- 4 expansion slots
- 3 game port connectors
- 3 floppy disk drives
- IBM PC/XT & Super XT
- Only 54 pins power consumption

\$149
Cat X-1001

BIOS for motherboard \$39.95
Cat X-1000

IBM PC/AT \$899
Cat X-1003

Multi-function Card

- Fully featured expansion card
- Compatible to 384K
- One 5.25" floppy disk
- One 800 baud modem
- One 800 baud printer
- One 800 baud scanner

\$119.95
Cat X-1005

Color Graphics Adapter Card

- 100% IBM compatible
- Compatible to 640K
- 4 channel serial ports
- 4 expansion slots
- 3 game port connectors
- 3 floppy disk drives
- IBM PC/XT & Super XT
- Only 54 pins power consumption

\$89.95
Cat X-1003

Floppy Disk Drive Adapter

- Works 2 internal 5.25" floppy disk drives
- Compatible to 640K
- 4 channel serial ports
- 4 expansion slots
- 3 game port connectors
- 3 floppy disk drives
- IBM PC/XT & Super XT
- Only 54 pins power consumption

\$44.95
Cat X-1008

Monochrome Graphics Printer Card

- 100% IBM compatible
- Compatible to 640K
- 4 channel serial ports
- 4 expansion slots
- 3 game port connectors
- 3 floppy disk drives
- IBM PC/XT & Super XT
- Only 54 pins power consumption

\$119.95
Cat X-1012

Multi I/O Card

- Fully featured expansion card
- Compatible to 384K
- One 5.25" floppy disk
- One 800 baud modem
- One 800 baud printer
- One 800 baud scanner

\$129.95
Cat X-1016

Winchester Disk Controller Card

- 100% IBM compatible
- Compatible to 640K
- 4 channel serial ports
- 4 expansion slots
- 3 game port connectors
- 3 floppy disk drives
- IBM PC/XT & Super XT
- Only 54 pins power consumption

\$174.95
Cat X-1018

SPECIAL DICK SMITH PACKAGE PRICE!

XT Motherboard	X-1001	\$149.00
BIOS for Motherboard	X-1000	\$39.95
84 x Ram	X-1017	\$149.00
Monochrome Graphics Card	X-1012	\$119.95
Printer Disk Controller	X-1008	\$44.95
100 Mega-Byte Hard Drive	X-1100	\$169.95
IBM PC/AT	X-1003	\$899.00
IBM compatible Micro Monitor	X-1132	\$149.95
48K Controller	X-1133	\$79.95

only \$659
Save \$129.95 on individual parts!

Every computer product comes with a 12-month warranty.



12" Monochrome Monitors

- IBM compatible
- Apple compatible
- 500 lines resolution
- 100% IBM compatible
- 4 channel serial ports
- 4 expansion slots
- 3 game port connectors
- 3 floppy disk drives
- IBM PC/XT & Super XT
- Only 54 pins power consumption

\$99.95
EACH

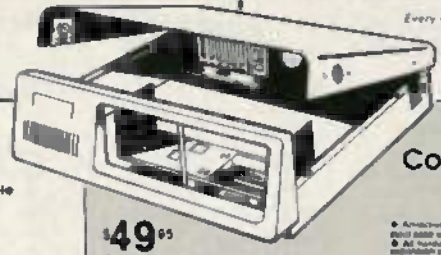

IBM PC/XT Compatible Case

\$49.95
Cat X-1120

- Attractive 19" wide heavy duty
- 100% IBM compatible
- 4 channel serial ports
- 4 expansion slots
- 3 game port connectors
- 3 floppy disk drives
- IBM PC/XT & Super XT
- Only 54 pins power consumption



130W Switching Regulated Power Supply

- 100% IBM compatible
- Compatible to 640K
- 4 channel serial ports
- 4 expansion slots
- 3 game port connectors
- 3 floppy disk drives
- IBM PC/XT & Super XT
- Only 54 pins power consumption

\$89.95
Cat X-1110



Joystick for IBM & Apple

- 100% IBM compatible
- Compatible to 640K
- 4 channel serial ports
- 4 expansion slots
- 3 game port connectors
- 3 floppy disk drives
- IBM PC/XT & Super XT
- Only 54 pins power consumption

\$19.95
Cat X-1138

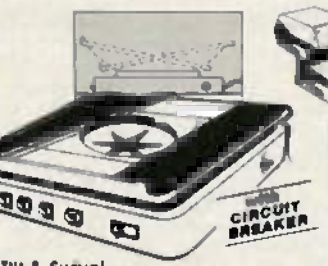

Disk Copy Holder

- 100% IBM compatible
- Compatible to 640K
- 4 channel serial ports
- 4 expansion slots
- 3 game port connectors
- 3 floppy disk drives
- IBM PC/XT & Super XT
- Only 54 pins power consumption

\$19.95
Cat X-1503



Tilt & Swivel Power Command Center

- 100% IBM compatible
- Compatible to 640K
- 4 channel serial ports
- 4 expansion slots
- 3 game port connectors
- 3 floppy disk drives
- IBM PC/XT & Super XT
- Only 54 pins power consumption

\$39.95
Cat X-1128

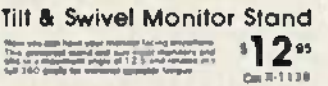

Tilt & Swivel Monitor Stand

- 100% IBM compatible
- Compatible to 640K
- 4 channel serial ports
- 4 expansion slots
- 3 game port connectors
- 3 floppy disk drives
- IBM PC/XT & Super XT
- Only 54 pins power consumption

\$12.95
Cat X-1138

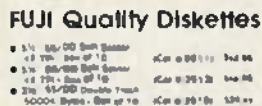

FUJI Quality Diskettes

- 5 1/4" 5.25" 800k 5 disk pack
- 5 1/4" 5.25" 100k 5 disk pack
- 5 1/4" 5.25" 100k 5 disk pack
- 5 1/4" 5.25" 100k 5 disk pack

\$49.95
Cat X-1011



Microcassette Cassettes

- 100% IBM compatible
- Compatible to 640K
- 4 channel serial ports
- 4 expansion slots
- 3 game port connectors
- 3 floppy disk drives
- IBM PC/XT & Super XT
- Only 54 pins power consumption

\$95.00
Cat X-1509

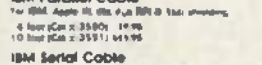

Printer Cables

- 100% IBM compatible
- Compatible to 640K
- 4 channel serial ports
- 4 expansion slots
- 3 game port connectors
- 3 floppy disk drives
- IBM PC/XT & Super XT
- Only 54 pins power consumption

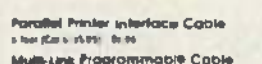

Parallel Printer Interface Cable

- 100% IBM compatible
- Compatible to 640K
- 4 channel serial ports
- 4 expansion slots
- 3 game port connectors
- 3 floppy disk drives
- IBM PC/XT & Super XT
- Only 54 pins power consumption

\$6.95
Cat X-1511

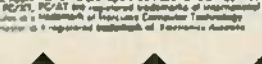

Multi-Line Programmable Cable

- 100% IBM compatible
- Compatible to 640K
- 4 channel serial ports
- 4 expansion slots
- 3 game port connectors
- 3 floppy disk drives
- IBM PC/XT & Super XT
- Only 54 pins power consumption

\$19.95
Cat X-1506

Disk Storage Files

- 100% IBM compatible
- Compatible to 640K
- 4 channel serial ports
- 4 expansion slots
- 3 game port connectors
- 3 floppy disk drives
- IBM PC/XT & Super XT
- Only 54 pins power consumption

\$49.95
Cat X-1120

High Quality Printed Circuit Board

- 100% IBM compatible
- Compatible to 640K
- 4 channel serial ports
- 4 expansion slots
- 3 game port connectors
- 3 floppy disk drives
- IBM PC/XT & Super XT
- Only 54 pins power consumption

\$149.95
Cat X-1001

Keyboards

- 100% IBM compatible
- Compatible to 640K
- 4 channel serial ports
- 4 expansion slots
- 3 game port connectors
- 3 floppy disk drives
- IBM PC/XT & Super XT
- Only 54 pins power consumption

\$79.95
Cat X-1172

100-Key Enhanced

- 100% IBM compatible
- Compatible to 640K
- 4 channel serial ports
- 4 expansion slots
- 3 game port connectors
- 3 floppy disk drives
- IBM PC/XT & Super XT
- Only 54 pins power consumption

\$99.95
Cat X-1124

Double Your Disk Capacity! Disk Notcher

- 100% IBM compatible
- Compatible to 640K
- 4 channel serial ports
- 4 expansion slots
- 3 game port connectors
- 3 floppy disk drives
- IBM PC/XT & Super XT
- Only 54 pins power consumption

\$7.95
Cat X-1504

DICK SMITH ELECTRONICS has been selling computers since 1977. Our experience & buying power assures you the best value. Watch our ads for more great computer accessories!

DISK DRIVES \$99.95 EACH

MODEL	X-1508	X-1507	X-1509
COMPATIBILITY	IBM PC/XT & compatibles	Apple IIc	Apple IIe & IIc
STORAGE CAPACITY	Double-sided Double-density 500 x Bytes 8.25 K Bytes 327.68 K Bytes 4096 Bytes 512 B/s 390 x B/s	Single-sided Double-density 125 x Bytes 3.125 K Bytes 27.68 K Bytes 125 x B/s	Single-sided Double-density 125 x Bytes 3.125 K Bytes 27.68 K Bytes 125 x B/s
Rotational Speed	5400 RPM	3600 RPM	3600 RPM
Access Time	10 ms	10 ms	10 ms
Seek Time	6 ms	6 ms	6 ms
Format Time	100 ms	100 ms	100 ms
Transfer Rate	300 K/s	300 K/s	300 K/s
Head Density	48 TP	48 TP	48 TP
Number of Tracks	30	30	30
Number of Cylinders	40	40	40
Number of Heads	2	2	2

10 Mega-Byte Hard Disk Drive \$389

- 100% IBM compatible
- Compatible to 640K
- 4 channel serial ports
- 4 expansion slots
- 3 game port connectors
- 3 floppy disk drives
- IBM PC/XT & Super XT
- Only 54 pins power consumption

\$389
Cat X-1510

Excellent REFERENCE Books

- IBM PC/XT Technical Service Data \$19.95
- IBM PC/XT Troubleshooting & Repair \$19.95
- Apple II/III & Technical Service Data \$19.95
- Apple II/III Technical Service Data \$19.95
- Apple Programmers Handbook \$19.95
- MAC Programming Handbook \$19.95
- Apple II Card & Description \$19.95
- Apple II Card Troubleshooting & Repair \$19.95
- Printer Connection Book \$19.95
- IBM Card to System \$19.95
- Microcomputer Troubleshooting \$19.95

80 Column/64K RAM \$49.95

- 100% IBM compatible
- Compatible to 640K
- 4 channel serial ports
- 4 expansion slots
- 3 game port connectors
- 3 floppy disk drives
- IBM PC/XT & Super XT
- Only 54 pins power consumption

\$49.95
Cat X-1017

\$12.95 Interfac Test Set

- 100% IBM compatible
- Compatible to 640K
- 4 channel serial ports
- 4 expansion slots
- 3 game port connectors
- 3 floppy disk drives
- IBM PC/XT & Super XT
- Only 54 pins power consumption

\$12.95
Cat X-1504

MODEM! VOYAGER 1200 \$169

- 100% IBM compatible
- Compatible to 640K
- 4 channel serial ports
- 4 expansion slots
- 3 game port connectors
- 3 floppy disk drives
- IBM PC/XT & Super XT
- Only 54 pins power consumption

\$169
Cat X-1100

CHALLENGER \$189

- 100% IBM compatible
- Compatible to 640K
- 4 channel serial ports
- 4 expansion slots
- 3 game port connectors
- 3 floppy disk drives
- IBM PC/XT & Super XT
- Only 54 pins power consumption

\$189
Cat X-1102

DISCOVERY \$39

- 100% IBM compatible
- Compatible to 640K
- 4 channel serial ports
- 4 expansion slots
- 3 game port connectors
- 3 floppy disk drives
- IBM PC/XT & Super XT
- Only 54 pins power consumption

\$39
Cat X-1112

MARK V ELECTRONICS INC.

248 EAST MAIN STREET, SUITE 100,
ALHAMBRA, CA 91801
TELEX 3716914 MARK 5

TOLL FREE FOR ORDERS PAID BY MASTER OR VISA CARD

PLEASE CALL 1-800-521-MARK
IN CALIFORNIA CALL: 1-818-282-1196
MAIL ORDERS P.O. BOX 7065 ALHAMBRA, CA 91807
INFORMATION 1-818-282-1130

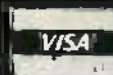

CALL OR WRITE FOR A FREE CATALOG — OVER 60 HOT & WELL-QUALIFIED ITEMS FOR YOUR SELECTION!

TR-100 0-15V 2A REGULATED DC POWER SUPPLY



- Output voltage is adjustable from 0-15v DC, has current limit range and available for selection: 200mA or 2A.
 - An elaborate protection system is specially designed, a "BB" sound and a positive light will appear when the output is overloaded or short-circuit.
 - High stability and reliable resulting from employing high quality voltage regulators IC.
 - Possessing long life meter makes the reading of voltage and current more clearly and accurately.
- A refined case, meter and all accessory are enclosed for both kit and assembly form. Most suitable for factory, probe amplifier even amplifier.

Kit \$59.50
Ass. with tested \$49.50

CORDLESS SOLDERING IRON RECHARGEABLE

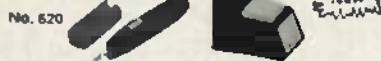

The most perfect handy, lightweight soldering iron for work shop, home, hobby & outdoor work...
Includes UL approval charger & cleaning sponge.
With built in solder point illumination.

Each set \$22.80

TALKING CLOCK



1. Talk, push button for 9999 announcement of time.
 2. Read out, twelve hours system display for hour, minute, second by using digital AM & PM.
 3. Display, three display modes of time, alarm time & date.
 4. Alarm, on off touch with thirty seconds alarm.
 5. Snooze, reminder voice alarm of thirty seconds after a minutes of first voice alarm.
 6. Volume, two level of voice output.
 7. Language available English, Mandarin.
- Mynah 8801 \$29.99 NOT A KIT

3 1/2 DIGITAL MULTIMETER

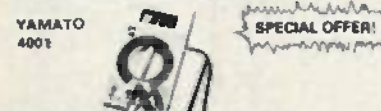

The YAMATO 4001 is a 3 1/2 DIGIT COMPACT DIGITAL MULTIMETER. It employs FE type LCD, with large figures. Its ADVANTAGES: High accuracy in measuring. High impedance assures dist. measuring error. One rotary switch allows fast & convenient operation. 20 measurement ranges enable wider application. Over-heat indication & low battery life appear on display. LED circuit test provides high reliability and durability. Measurement possible even under strong magnetic field.

Not a KIT, assembled with tested \$23.80

80W + 80W DC LOW TIM PRE-MAIN AMPLIFIER TA-800



Kit \$46.95
Metal Cabinet/X-Former (Optional) \$23.99/\$22.00

TA-1500 100W + 100W NEW CLASS 'A' DC STEREO PRE-MAIN AMPLIFIER



- Features:
1. Preamp employs three LOW NOISE Op Amps as IIAA equalizer and 20dB flat amplifier and tone control. It has very good transient response and low noise. It is easy to build up.
 2. Power Amp employs our powerful audio transistors and an advanced dynamic class 'A' circuit. The dissipation is extremely low and this makes the output stage of minimal switching distortion. It can reproduce high level bass faithfully.
 3. A specially designed delay system is included and the functions contains: (a) three seconds delay, (b) digital short circuit protection, (c) DC output protection. It also equipped with LED indicator of double display.
 4. It includes a microphone meter, so you can sing with those famous singers together. It can also be used as a Public Address Amplifier.

Kit \$67.00
Metal Cabinet/X-Former (Optional) \$23.99/\$22.00

10W AC/DC SHOULDER AMPLIFIER TA-008



TA-008 employs the most advanced LC, of TOSHIBA, as a main device, the sound is powerful, it can be supplied by only 4 pieces of 'UM-1' 1.5V battery or AC to DC 9V adapter. It is simple to operate, just 'press-to-test', and with ON/OFF power switch on the radio, speaker, while it is wrapped and with light weight, so it is convenient to bring along to both indoor and outdoor activities. Please Read our catalog for details.

Assembled with tested \$49.00

STEREO SIMULATOR TA-3000



Kit ONLY \$25.00 (Case included)

You can own a stereo TV from today! This simulator is a special design of using the most advanced monoisolated LSI. It produced a superior analog stereo effect since the LSI is equipped 80 pcs of LOW NOISE FET & TRANSISTOR. The simulator can even help you to promote your television from a normal one to a special one with a Hi-Fi STEREO function. Our simulator is also applicable to any other 'mono sources' by converting it to ANALOG STEREO. Undoubtedly, it is the most advanced equipment for every family, while it should contribute to your listening pleasure.

Ass. with tested \$30.00

COLOR LIGHT CONTROLLER TY-238



As a result of the advanced technology, this unit can control various colored light tubes, the visual effect of which is most available in places like party, disco, electronic game centre and also in lightings for advertisement. Total output power is 3000W (1000W/Ch) which means that it can control 30 pieces of 100W or 800 pieces of 5W color light which is enough for most usages.

Kit \$66.99
Ass. with tested \$76.80

TA-2400A ELECTRONIC ECHO AND REVERBERATION AMPLIFIER



This unit combines the most advanced VLSI technique with high quality, Japan made components & has the following FEATURES:

- It can generate various reflection and reverberation effects as those occurring in valleys and music halls. It has 3 special effect controls which include reverberation control, delay control and depth control. Special effect can be made in your record tapes by using this model. As kinds of infinite sound effect can be obtained by skilful use of this control. It has LED display to show reflection and reverberation.

Ass. with tested \$99.95

HIGH QUALITY MULTIPURPOSE PRE-AMPLIFIER TA-2500



This specially designed pre-amplifier includes a Professional GRAPHIC EQUALIZER tone control system and has a gain of ±12dB. Frequency response extends from 5Hz to 20KHz, so as to ensure best performance in whatever adverse condition. It can accept input from various magnetic cartridge, record deck, CD player and tuner; its output can be connected to all kinds of power amplifiers.

Assembled with tested \$82.80

120W MOSFET POWER AMPLIFIER TA-477



This amplifier consists of three super low TIM differential stages, and Hirsch 25.4dB 2SK 134 match pair 'MOSFET' as output component whose frequency is 100KHz and transient response is superior to the other power transistor. Therefore this amplifier has high-fidelity and superior analytic power over the entire Audio Spectrum. It is suitable for reproducing classic and modern music. Heavy Duty Heat Sink with 78 radial fins is included!

Kit \$59.00
Metal Cabinet/X-Former (Optional) \$23.99/\$22.80

Model No.	Description	Kit/Assembled	Unit Price	Model No.	Description	Kit/Assembled	Unit Price
TA-007	18V Mini-Amplifier	Kit	\$3.80	TR-355 A, B	3-BA REGULATED DC POWER SUPPLY	Kit	\$16.80
TA-008	8W Mini Amplifier	Kit	\$4.82	TR-903	0-50V 2A POWER SUPPLY WITH SHORT CIRCUIT BREAK & OVERLOAD PROTECTOR	Kit	\$12.30
TA-007	12W Stereo Power Booster	Kit	\$8.00	TR-100	0-15V 2A REGULATED DC POWER SUPPLY	Kit	\$12.30
TA-008	AC/DC SHOULDER AMPLIFIER	Ass.	\$48.00	TY-1A MK4	BATTERY FLUORESCENT LIGHT ELECTRONIC TOUCH SWITCH	Kit	\$9.50
TA-10	STEREO PRE-AMPLIFIER WITH MAGNETIC MIC AMP	Kit	\$6.00	TY-7	MULTI-FUNCTIONAL CONTROL RELAY	Kit	\$3.99
TA-50 A, B	MULTI-PURPOSE MELODY GENERATOR	Kit	\$10.78	TY-11A	DIGITAL CLOCK WITH TWO TIMER	Kit	\$19.80
TA-120	PURE CLASS 'A' MAIN POWER AMPLIFIER	Kit	\$25.00	TY-15	COLOR LED VU METER	Kit	\$3.80
TA-202	70W AC/DC STEREO AMPLIFIER	Ass.	\$80.00	TY-14	ELECTRONIC SHOCK	Kit	\$7.80
TA-300	300W Multi-Purpose Single Channel Amp	Kit	\$11.07	TY-18	HIGH PRECISION SOUND CONTROL SWITCH	Kit	\$19.50
TA-302	80W Stereo Power Booster	Ass.	\$50.00	TY-20	SUPER SENSITIVE AUDIO LEVEL INDICATOR	Kit	\$65.00
TA-322A	High Quality 20W+20W Stereo Amplifier	Kit	\$24.50	TY-73B	COLOR LIGHT CONTROLLER	Ass.	\$75.00
TA-322B	80W DC Stereo Pre-Amplifier & Power Amplifier	Kit	\$29.50	TY-75	SPEAKER PROTECTOR	Kit	\$7.80
TA-400	40W TRANSISTORIZED MONO AMPLIFIER	Kit	\$11.84	TY-35	FM WIRELESS MICROPHONE	Kit	\$16.82
TA-477	120W MOSFET POWER AMPLIFIER	Kit	\$55.00	TY-38	AC/DC QUARTZ DIGITAL CLOCK	Kit	\$10.00
TA-800	160W DC LOW TIM PRE-AMPLIFIER & POWER AMP	Kit	\$49.95	TY-39	SOUND OR TOUCH CONTROL SWITCH	Kit	\$25.00
TA-802	160W PURE DC ST. POWER AMP, W/SPK. PROTECTOR	Ass.	\$39.95	TY-41 MKIII	INFRARED REMOTE CONTROL UNIT	Ass.	\$30.00
TA-820A	120W 00L DC PRE-MAIN & STEREO AMPLIFIER	Kit	\$43.00	TY-42	BAR/DOOR LEVEL METER	Kit	\$21.00
TA-1000A	100W DYNAMIC CLASS 'A' MAIN POWER AMP (MONO)	Kit	\$45.50	TY-45	BAR/DOOR AUDIO LEVEL DISPLAY	Kit	\$34.95
TA-1500	200W NEW CLASS 'A' DC STEREO PRE-MAIN AMP	Kit	\$67.00	TY-47	SUPERIOR ELECTRONIC ROULETTE	Kit	\$16.82
TA-2400A	ELECTRONIC ECHO AND REVERBERATION AMP	Ass.	\$59.95	YAMATO 4001	3 1/2 DIGITAL MULTIMETER	Kit	\$23.80
TA-2800	HIGH QUALITY MULTI-PURPOSE PRE-AMPLIFIER	Ass.	\$82.00	T1	LCD THERMOMETER CLOCK WITH 8 OUT DOOR SENSOR	Kit	\$20.00
TA-2200	DC FET SUPER CLASS 'A' PRE-AMPLIFIER	Kit	\$38.00	T2	LCD THERMOMETER CLOCK WITH 8 C° MEASURING	Kit	\$19.00
TA-2800	NP-CR BIFET PRE-AMP WITH 2WAY TONE CONTROL	Ass.	\$36.80	8504	TALKING CLOCK MYNACH (GOLDEN OR BLACK)	Kit	\$28.00
TA-3000	STEREO SIMULATOR	Kit	\$25.00	NO. 620	CORDLESS SOLDERING IRON RECHARGEABLE	Kit	\$27.80
SM-43	3 1/2 MULTI-FUNCTIONAL LED D.P.M.	Kit	\$29.22				
SM-46	3 1/2 HI-PRECISION D.P.M.	Ass.	\$35.00				
SM-100	150MC UNIVERSAL DIGITAL FREQUENCY COUNTER	Kit	\$43.50				
TY-49	3 1/2 DIGITAL PANEL METER	Ass.	\$99.00				
		Kit	\$28.00				

TERMS: Minimum order: \$10.00. Charge card order \$20.00. No C.O.D. Money order, phone order accept. CA residents must include 6.5% sales tax. Prices are subject to change without notice. All merchandise subject to prior sale. Shipping & handling: Inside L.A. 5% of total order (Min \$1.50). Outside L.A. 10% of total order (Min \$2.50). Outside U.S.A. 20% of total order (Min \$5.00). Shipped by UPS ground.

HOURS: Mon-Fri 9:30 to 5:00, Sat 9:30 to 1:00 (PACIFIC TIME)
NATION-WIDE DISTRIBUTORS WANTED FOR OUR PRODUCTS. QUANTITY DISCOUNTS AVAILABLE!
CIRCLE 93 ON FREE INFORMATION CARD

7400

Part No.	Price	Part No.	Price
SN7400DN	19	SN7489N	55
SN7400FN	19	SN7489FN	35
SN7400FN	25	SN7489FN	1.80
SN7400FN	29	SN7489FN	30
SN7400FN	29	SN7489FN	30
SN7407N	20	SN74121N	20
SN7408N	25	SN74123N	40
SN7410N	18	SN74123N	40
SN7414N	40	SN74123N	40
SN7416N	30	SN74142N	3.95
SN7417N	30	SN74173N	1.20
SN7420N	18	SN74184N	1.25
SN7420N	19	SN74184N	1.30
SN7422N	20	SN74173N	.75
SN7428N	20	SN74173N	.75
SN7429N	45	SN74173N	.50
SN7445N	60	SN74173N	.50
SN7445N	70	SN74181N	1.95
SN7447N	70	SN74189N	1.95
SN7448N	70	SN74193N	.80
SN7479N	35	SN74198N	1.35
SN7479N	35	SN74221N	.80
SN7479N	35	SN74221N	1.95
SN7479N	30	SN74306N	.50
SN7479N	30	SN74306N	.50

74LS

74LS00	19	74LS195	.70
74LS02	19	74LS196	.80
74LS04	25	74LS173	.40
74LS05	25	74LS174	.30
74LS08	90	74LS174	.30
74LS07	90	74LS174	3.95
74LS08	19	74LS191	.60
74LS10	19	74LS193	.40
74LS14	30	74LS221	.50
74LS27	25	74LS240	.60
74LS30	19	74LS243	.60
74LS32	25	74LS244	.60
74LS42	30	74LS245	.70
74LS47	60	74LS290	1.19
74LS73	35	74LS273	.70
74LS74	25	74LS279	.70
74LS75	25	74LS322	2.90
74LS76	20	74LS365	.30
74LS86	40	74LS366	.30
74LS86	25	74LS367	.30
74LS90	30	74LS368	.30
74LS93	40	74LS374	.70
74LS123	40	74LS374	.70
74LS173	30	74LS303	.70
74LS138	30	74LS390	5.95
74LS138	30	74LS624	1.65
74LS184	40	74LS629	2.60
74LS197	35	74LS640	.80
74LS150	40	74LS645	.90
74LS183	40	74LS670	.90
74LS184	40	74LS688	1.95

74S/PROM

74S00	20	74S188	1.75
74S04	30	74S198	1.95
74S08	30	74S198	1.95
74S10	20	74S260	1.40
74S32	35	74S244	1.40
74S74	40	74S283	.70
74S86	1.40	74S287	1.60
74S86	30	74S287	1.60
74S124	2.70	74S373	1.60
74S174	70	74S374	1.60
74S175	70	74S374	3.40

74ALS

74ALS00	35	74ALS196	.80
74ALS02	35	74ALS174	.80
74ALS04	30	74ALS174	.80
74ALS08	35	74ALS240	1.70
74ALS10	30	74ALS244	1.70
74ALS27	30	74ALS244	2.40
74ALS30	35	74ALS279	1.95
74ALS32	39	74ALS374	1.95
74ALS74	55	74ALS873	1.95

74F

74F00	50	74F138	1.20
74F04	60	74F157	1.20
74F08	50	74F190	4.95
74F10	60	74F200	2.40
74F32	85	74F244	2.40
74F74	80	74F283	1.70
74F86	80	74F373	2.95
74F138	110	74F374	2.95

CD - CMOS

CD4001	10	CD4091	25
CD4011	19	CD4092	25
CD4013	30	CD4093	30
CD4018	20	CD4094	1.40
CD4017	40	CD40103	2.95
CD4018	80	CD4503	4.90
CD4020	50	CD4810	.80
CD4024	60	CD4511	.80
CD4027	30	CD4518	1.30
CD4030	30	CD4518	.70
CD4040	80	CD4520	.70
CD4048	20	CD4522	.70
CD4090	20	CD4530	.80
CD4091	20	CD4534	.80
CD4092	20	CD4534	.80
CD4093	20	CD4553	4.80
CD4094	3.40	CD4556	.80
CD4096	90	CD4566	1.95
CD4096	20	CD4563	1.10
CD4099	25	CD4564	.80
CD4099	20	CD4566	.80
CD4071	25	MC14411	0.95
CD4072	25	MC14409F	4.40
CD4075	80	MC14572	.80

CUSTOM COMMODORE CHIPS

For VIC-20, C-64 and C-128 Personal Computers

Part No.	Price	Part No.	Price	Part No.	Price
*8510CPU	4000- 9.95	*6560VIC-I	2000- 14.95	82S100PLA	82-86 19.95
*6525TM	2000- 9.95	*6567VIC-II	4000- 19.95	*8701 Clock Chip	19.95
*6526CIA	8000- 14.95	*6581SID	4000- 19.95	*8721	82-86 9.95

*Specs Available @ \$1.50 ea. NOTE: 82S100 = U17 IC-64

MOTOROLA MC68701-Microcomputer with EPROM

The MC68701 is an 8-bit single chip microcomputer unit (MPU) which significantly enhances the capabilities of the MC6800 family of parts. On-chip resources include 2048 bytes of EPROM, 128 bytes of RAM, Serial Communications interface (SCI), parallel I/O and a three function Programmable Timer.

MC68701 \$24.95

MICROPROCESSOR COMPONENTS

MICROPROCESSOR CHIPS		6800/6801/6808 Cost.		6800 SERIES Cost.	
Part No.	Price	Part No.	Price	Part No.	Price
D788AC	4.95	6843	9.95	8237-5	6.95
CDP1802CE	5.95	6845	4.95	8243	2.40
2601-3	6.95	6850	1.95	8250A	6.95
Z80	1.70	6852	4.75	8250B (For 6800)	7.25
Z80-CTC	1.70	6800LS	9.95	8281A	2.20
Z80-DART	4.95	6801	8.95	8223-5	2.20
Z80-PD	1.70	6808	9.95	8254	9.95
Z80A	1.95	6031	6.95	8254-2	11.95
Z80A-CTC	1.80	80C31B4	19.95	8256A-5	2.25
Z80A-DART	5.25	8035	1.95	8257-5	2.40
Z80A-PD	1.80	8073H	29.95	8258-5	2.40
Z80A-SIO	5.25	8080A	3.95	8272	4.95
Z80C	4.95	8085A	2.75	8279-5	2.95
Z80C-CTC	4.95	8086-2	10.95	8741	8.95
Z80B-RO	4.90	8088-2	12.95	8748	7.95
8500 6800/6808 SER.		8087 (3MHz)	190.95	8749	9.95
8802	2.75	8087-2 (3MHz)	190.95	8751	29.95
8820	2.95	8116	8.95	8755	14.95
8822	4.95	8188	2.75	ADDC80A	3.40
8832	8.40	8188-8	3.95	ADDC80B	6.95
8551	6.95	8150	2.75	ADDC80C	3.95
8800	1.95	8202	9.95	ADDC81B	14.95
8802	4.95	8203	9.95	ADDC82B	1.95
8810	1.95	8212	1.80	DAC100B	7.95
8821	1.95	8224	2.25	AY-3-1015D	4.95
8840	8.75	8228	3.40	AY-5-1013A	3.95

DYNAMIC RAMS

Part No.	Function	Price
4116N-15	16,384 x 1 (150ns)	.80
4128	131,072 x 1 (200ns)	5.95
4184N-15	65,536 x 1 (150ns)	1.25
4184N-200	65,536 x 1 (200ns)	1.15
TMS4418-12	16,384 x 4 (150ns)	4.90
NM5260	4096 x 1 (200ns) 2107	1.90
8118	16,384 x 1 (150ns) (+5V Only Required)	2.80
41256-180	262,144 x 1 (150ns)	2.80
50464-15	65,536 x 4 (150ns) (4464) (41464)	5.40

STATIC RAMS

TMS2016-12	2048 x 6 (125ns)	1.60
2102	1024 x 1 (250ns)	1.40
2102-2L	1024 x 1 (250ns) LP, 0V1LREQ	1.40
2114N	1024 x 4 (450ns)	1.00
2114N-L	1024 x 4 (450ns) LP	1.00
2114N-2	1024 x 4 (200ns) LP	1.05
2114N-2L	1024 x 4 (200ns) LP	1.40
21C14	1024 x 4 (200ns) (CMOS)	4.80
2149	1024 x 4 (40ns)	4.80
5101	256 x 4 (40ns) CMOS	3.95
HM6116P-3	2048 x 6 (150ns) CMOS	1.40
HM6164P-12	2048 x 6 (150ns) CMOS	4.00
HM6264LP-12	8192 x 6 (120ns) LP CMOS	4.20
HM6264P-15	8192 x 6 (150ns) CMOS	3.75
HM6264LP-15	8192 x 6 (150ns) LP CMOS	3.80
6514	1024 x 4 (350ns) CMOS (LIFO444C)	4.40

PROMS / EPROMS

1702A	256 x 8 (100ns)	5.95
TMS2516	4096 x 8 (450ns) 25V	4.95
TMS2532	4096 x 8 (450ns) 25V	5.95
TMS2564	8192 x 8 (450ns) 25V	9.90
2708	1024 x 8 (450ns)	3.90
TMS2716	2048 x 8 (450ns) 3 voltage	9.90
2718	2048 x 8 (450ns)	4.90
2716-1	2048 x 8 (350ns) 25V CMOS	5.95
27C16	2048 x 8 CMOS	9.90
2732	4096 x 8 (450ns)	4.75
2732A-20	4096 x 8 (200ns) 21V	4.90
2732A-25	4096 x 8 (200ns) 21V	4.40
2732A-45	4096 x 8 (450ns) 21V	4.25
27C32	4096 x 8 (450ns)	7.95
2758	1024 x 8 (450ns) Single +5V	5.95
2784-20	8192 x 8 (200ns) 21V	4.40
2784-25	8192 x 8 (250ns) 21V	4.25
2784A-25	8192 x 8 (250ns) 12.5V	4.40
2704-45	8192 x 8 (450ns) 21V	3.95
27C64	8192 x 8 (250ns) 21V	8.95
27128-25	16,384 x 8 (250ns) 12.5V	4.40
27128A-25	16,384 x 8 (250ns) 25V	5.95
27256-25	32,768 x 8 (250ns) 25V (12.5V)	7.95
27C256-25	32,768 x 8 (250ns) 25V (CMOS) (12.5V)	10.95
8875A	8192 x 8 (350ns) 25V	15.95
8876A	8192 x 8 (350ns) 25V	16.95
74S387	256 x 8 PROM O.C.	1.60
74S471	256 x 8 PROM T.S.	4.90
82S123	32 x 8 PROM T.S.	2.90
82S129	256 x 4 PROM T.S.	2.90

LOW PROFILE (TIN) SOCKETS

Part No.	1-8	10-99	100-ud
8 pin LP	.13	.12	.11
14 pin LP	.15	.13	.11
24 pin LP	.17	.15	.13
28 pin LP	.21	.20	.20
40 pin LP	.49	.46	.43

— SOLDERSHAW STANDARD (GOLD & TIN) AND HEADER PLUS SOCKETS ALSO AVAILABLE —

SATELLITE TV DESCRAMBLER

The MM5321 is a TV camera sync generator designed to supply the basic sync functions for either color or monochrome \$25 line/60Hz interlaced and camera video records applications. **COLOR BURST GATE & SYNC ALLOW STABLE COLOR OPERATION \$9.95!**

DIGITALKOR

DT1050 — Applications: Teaching aids, appliance clocks, automotive, telecommunications, language travel films, etc. The DT1050 is a standard DIGITALKOR bit encode with 137 separate and useful words, 2 tones, and 5 different sentence durations. The words and tones have been assigned discrete addresses, making it possible to output single word or word concatenated into phrases or even sentences. The "word" output of the DT1050 is a highly intelligible male voice. The DT1050 consists of a Speech Processor Chip 82S5411 (80-pin) and two (2) Speech ROMs 82S1645B1 or 82S21645B2 (24-pin) along with a Master Word list and recommended schematic diagram as an application sheet.

DT1050	Digitalkor	\$24.95
MM54104	Processor Chip	\$12.90

DT1057 — Expands the DT1050 vocabulary from 11 words to over 250 words. Includes two (2) ROMs and a DT1057. **\$11.95**

INTERSIL

Part No.	Price	Part No.	Price
FE0203D	12.95	7207AEV/KOL	6.0
FE0203D	12.95	7211PL (TLU)	7.5
7100CPD	8.95	7211NPL (Micro)	8.0
7108N	46.95	74HC274	1.10
7107OP	8.95	7221AFL	8.1
7107E	46.95	7224AFL	10.1
7207APD	5.95	7228AEV/KOL	9.1

74HC HI-SPEED CMOS

74HC00	35	74HC175	1.1
74HC02	30	74HC221	1.1
74HC04	30	74HC240	1.1
74HC08	30	74HC244	1.1
74HC10	30	74HC245	1.1
74HC14	50	74HC283	1.1
74HC30	30	74HC290	1.1
74HC32	40	74HC273	1.1
74HC74	40	74HC373	1.1
74HC75	60	74HC374	1.1
74HC86	60	74HC390	1.1
74HC85	1.10	74HC565	1.1
74HC86	50	74HC566	1.1
74HC123	1.10	74HC4040	1.1
74HC125	50	74HC4046	1.1
74HC13			

Worldwide • Since 1974

• QUALITY COMPONENTS • COMPETITIVE PRICING
• PROMPT DELIVERY

Mail Order Electronics Worldwide
Jameco
ELECTRONICS

COMMODORE™ COMPATIBLE ACCESSORIES

Now Compatible With C-128!
RS232 Adapter for VIC-20, C-64 and C-128

The RS232C adapter allows connection of standard serial RS232C inter-computer, modems, etc. to your VIC-20, C-64 (excluding the 584 Portable), and C-128. A 4-pin outlet allows the extension of the 4 control lines. Complete installation and operation instructions included.

Plugs into User Port - Provides Standard RS232C signal levels. Uses 6 signals (Transmit, Receive, Clear to Send, Request to Send, Data Terminal Ready, Data Set Ready).

E232CM \$39.95
Voice Synthesizer VIC-20 & C-64
Plug-In - Talking in Minutes!
E520CM \$99.95

300 Baud Auto Modem
Litey-MC (For C-64) \$69.95
Parallel Printer Interface
FREE 10K Buffer Included!
IW350 (For VIC-20, C-64 & C-128) \$69.95

TRS-80™ COMPATIBLE ACCESSORIES

E-X-P-A-N-D TRS-80 MEMORY
All kits come complete with documentation
TRS-80 MODEL I, III
TS-16K3 200ns (Model III) \$5.95
TS-16K4 250ns (Model I) \$5.95

TRS-80 COLOR AND COLOR II
TS-64K-2 \$11.95
New models only
TS-CoCo-Incl. 2-50464's (41684's) \$15.95

TRS-80 MODEL 4, 4P
TS-64K-2 \$11.95
pends Model 4 from 10K-64K or Model 4P from 64K-128K
TS-64K-2PAL \$29.95
pends Model 4 from 64K to 128K

RS-80 Model 100 • NEC • Olivetti
1008K \$29.95 ea. or 3 for \$79.95
2-80 Model 100 Expansion
EC2KR \$29.95 ea. or 3 for \$79.95
3C Model PC-8201A Expansion
M108K \$29.95 ea. or 3 for \$79.95
with Model M10 Expansion

TANDY 200
200R \$89.95 ea. or 2 for \$169.95
200 Model 200 Expansion

UV-EPROM ERASER

E-4 UV-EPROM Eraser \$74.95
VS-11EL Replacement Bulb \$17.95

Erases all EPROMs. Erases up to 8 chips within 21 minutes (chip in 15 minutes). Maintains constant exposure distance 1". Special conductive beam lens eliminates static build-up. 2" in safety lock to prevent UV exposure. Compact - 8.00" L, 1.70" W x 2.80" H. Complete with holding tray for 8 chips.

DATA BOOKS
1003 National Linear Data Book (82) \$18.95
1009 National Data Book (85) \$ 9.95
1013 Zilog Data Book (88) \$14.95
1022 Intel Logic Data Book (84) \$24.95
1030 Intel Memory Handbook (83/84) \$19.95
10843 Intel Microprocessors (82/84) \$19.95

PUFFIN/SPLIT-STYLE FANS

MUF60 (SPN3-16-7482) \$9.95
Howard Industries (4.60" dia., 60 cfm)
SU2C7 \$9.95
EG&G Robton (3.125" square, 20 cfm)

NEW PRODUCTS!

ZUCKERBOARD Expansion Memory Half Card and Clock/Calendar for the Tandy 1000

The Zuckerboard Expansion Memory Board allows you to expand the memory of your Tandy 1000 (128K Model) as much as 640K! 256K DRAM chips increase your computer's memory by either 256K or 512K, bringing your total system memory up to either 384K or 640K. The memory board also includes a DMA controller chip. Optional clock/calendar plugs directly onto the memory board. Manual included.

TAN-Clock Clock/Calendar Option (only) \$ 39.95
TAN-EM256K Includes 256K RAM \$ 99.95
TAN-EM512K Includes 512K RAM \$139.95

BIG BOARD 1M BYTE RAM CARD
for Apple II, II+ and IIe*

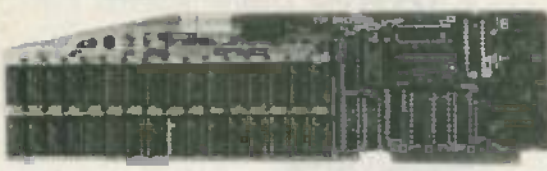

Introducing a third generation memory card that gives you both great expandability and great versatility at an extraordinary price. Versatility to users means that BIG BOARD is compatible with software written for the Symyx SSD (Flashcard) as well as for Jameco's JE868 128K RAM Card. Big Board makes available 426K of worksheet space, using the program THE Spreadsheet Version 2.0. It is compatible with PLUSWORKS XM for running Appletworks on the Apple II. Versatility also means that BIG BOARD comes complete with RAMDISK software for DOS 3.3, PRODOS, Pascal 1.2, and CP/M for Microsoft's BigCard. A separate driver is available for the AppleCard (StarCard).

BIG BOARD-256K 256K RAM \$224.95
BIG BOARD-512K 512K RAM \$269.95
BIG BOARD-1M 1Meg RAM \$299.95

1 Yr. Warranty! **External Power Supply for the Commodore 64**

eytes CPS-10 \$49.95
• Input: 117VAC @ 60Hz • Output: 5VDC @ 3 Amps, 10VAC @ 250mA • Short circuit protected and current limited • Transient spike suppression on two auxiliary 110VAC sockets • Switch on front serves as power switch for the computer and other peripherals • RFI/EMI filtered • Adjustable linear regulator • Has less than 50mV ripple rms at full load • 5 Amp primary fuse • Two conductor with ground line • Color - brown • Size 7 1/2" D x 5 1/4" W x 2 1/4" H • Weight: 5 lbs.

Serial to Parallel/Parallel to Serial Interface Converter

The ADAPTA™ Interface Converter performs either RS-232C serial to Centronics parallel port conversion or the reverse. An internal switch selects whether the device operates as a serial to parallel or parallel to serial converter. The basic module provides 2048 bytes of buffering. The buffer may be switched out if unbuffered operation is desired.

• Uses DTR and CTS to control the serial port data stream • Uses ACK and BUSY to control the parallel port data stream • 8 switch selectable baud rates: 110, 300, 600, 1200, 2400, 4800, 9600, 19200 • Switch selection allows 7 or 8 data bits, parity or non-parity and 1 or 2 stop bits • 8MNC adapter incl. • DB-25C serial and Centronics parallel connectors • Selectable control signal polarity • Size 5 1/4" L x 5 1/4" W x 1 1/4" H • Wt. 2 lbs. • Manual incl.

ADAPTA \$74.95

IBM™ COMPATIBLE ACCESSORIES

83-KEY KEYBOARD

Identical layout as original IBM PC Keyboard • Highly desirable case with palm rest • Complete with cable and data • JUST PLUG IN!

KB83 \$49.95
Build an IBM PC/XT™ Compatible!
IBM-64K 64K RAM Chips (18) \$ 24.98
KB-83 83-Key Keyboard \$ 49.95
IBM-FCC Floppy Controller Card \$ 54.95
IBM-Case Case \$ 49.95
IBM-MCC Monochrome Card \$ 89.95
IBM-PS Power Supply \$ 89.95
FD55B Disk Drive \$119.95
IBM-MON Monochrome Monitor \$109.95
IBM-MB Motherboard \$199.95

Regular List \$789.58
IBM™-Special (Over 9 items above) \$699.95

Additional Add-Ons Available!
IBM-KB 83-Key Keyboard \$ 79.95
IBM-ENH Enhanced Keyboard \$ 99.95
IBM-ICB Integrated Color Board \$109.95
IBM-E384K Multifunction Card \$169.95
IBM-20MBK 20MB Hard Disk Drive \$499.95

IBM is a registered trademark of IBM Computers

NEW! Universal NEW! 64K/256K Printer Buffer

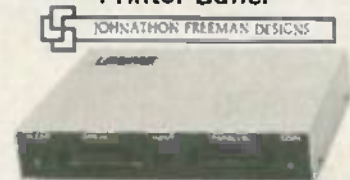

The UBUFFER Universal Printer Buffer is a hi-speed data buffer that accepts data at a high rate, and then outputs the data to your printer. You save valuable computer time. The UBUFFER can be connected to practically any computer or printer. There are four possible combinations: 1) Serial to Serial, 2) Serial to Parallel, 3) Parallel to Parallel, 4) Parallel to Serial. Manual included. Size 9-1/2" L x 4 1/4" W x 1 1/4" H.

UBUFFER-64K \$199.95
UBUFFER-256K \$229.95

IBM Compatible! DISK DRIVES
Documentation included

FD55B 5 1/4" 5 1/4" High \$119.95
SA455 5 1/4" 5 1/4" High \$139.95
TM100-2 Tandem 5 1/4" 5 1/4" High \$139.95

JMR 5 1/4" DISK DRIVE ENCLOSURES
Complete with power supply, switch, power cord, fuse-holder and connectors.

DDE-1FH Houses 1 Full Height 5 1/4" Floppy Drive \$69.95
ODE-2HH Houses 2 Half Height 5 1/4" Floppy Drives - Vertical \$79.95
HODE-1FH Houses 1 Hard Disk Drive \$199.95

\$20 Minimum Order - U.S. Funds Only
Shipping: Add 5% plus \$1.50 Insurance
California Residents: Add 6% or 6 1/2% Sales Tax
Spec. Sheets - 30c each
Prices Subject to Change

Send stamped, self-addressed envelope to receive a Quarterly Sales Flyer - FREE!
8/86
MasterCard
Jameco ELECTRONICS
VISA
Send \$1.00 Postage for a FREE 1986 JAMECO CATALOG
©1986 Jameco Electronics

1355 SHOREWAY ROAD, BELMONT, CA 94002 • PHONE ORDERS WELCOME 415-592-8097 Telex: 176043

CIRCLE 114 ON FREE INFORMATION CARD

TENMA

THE NAME YOU CAN TRUST IN ELECTRONIC TEST EQUIPMENT

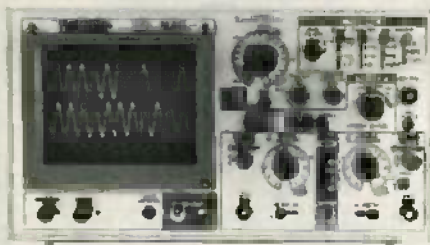

TENMA 35MHz Dual Trace Oscilloscope

- Two high quality 10:1 probes included
- For additional specification see MCM Catalog #12

#72-330
\$569⁹⁵ (ea.)

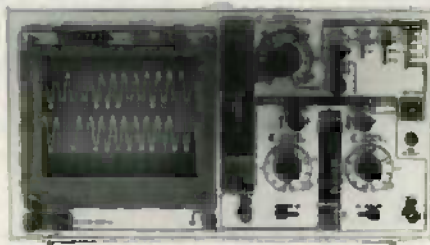

TENMA 20MHz Dual Trace Oscilloscope

- Two high quality 10:1 probes included
- For additional specification see MCM Catalog #12

#72-320
\$389⁹⁵ (ea.)

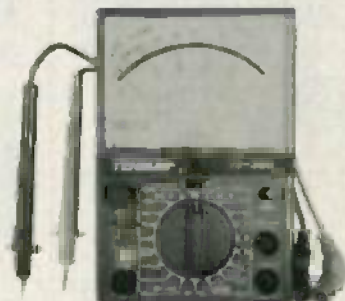

TENMA Analog Meter

- 3 1/2" mirrored scale
- Transistor good/bad and polarity checker
- Carrying case included

#72-385
\$21⁰⁰ (ea.)

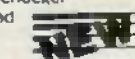

\$189⁵ (2-up)



TENMA 30A Power Supply

- Output voltage: 1-15VDC
- Lighted cross needle meter: Displays voltage, current and power simultaneously
- Output current: 30A, 22A continuous
- Fan cooled

#72-035
\$199⁰⁰ (ea.)

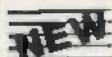

TENMA 0-18V 3A Power Supply

- Regulated Outputs — constant volt or constant current, both are continuously variable
- Can be connected in series or parallel for more voltage or current output
- Reverse polarity and overload protected
- Isolated output

#72-420
\$99⁵⁰ (ea.)

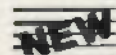

TENMA Digital LCR Meter

- Measures inductance, capacitance and resistance
- L = 1µH-200H, C = .1pF-200µF, R = .01ohm-20Mohm
- Carrying case included

#72-370
\$149⁹⁵ (ea.)



TENMA Combination Function Generator and Frequency Counter

- 6 digit display
- Output range: 2Hz-2MHz, seven ranges
- Counter range: .1Hz-10MHz
- 5-15V TTL and CMOS output
- Wave forms: sine, triangle, square, pulse, and ramp

#72-380
\$219⁹⁰ (ea.)

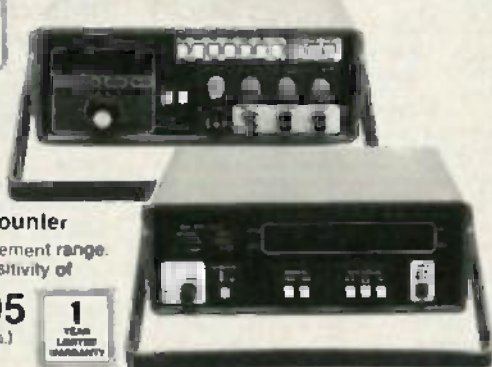

TENMA Frequency Counter

- 8 digit LED display
- Measurement range: 1Hz-120MHz
- High input sensitivity of 20mV RMS

#72-375
\$189⁹⁵ (ea.)



Be Sure To Call For Your FREE Catalog! Over 6,000 Items!

We also have ... a full line of test equipment, computer accessories, telephone accessories, speakers, television parts, flybacks, yokes, switches, fuses, lamps, capacitors, resistors, cartridges, stylus, wire, CATV equipment, the largest selection of original Japanese semiconductors in the country and more.



MCM ELECTRONICS
858 E. Congress Park Dr.
Centerville, Ohio 45458-4072
(513) 434-0031

SOURCE NO. RE-23

Terms:

- \$10 minimum order \$1.00 charge for orders under \$10
- \$20 minimum charge card order
- Orders shipped UPS C.O.D.
- Most orders shipped within 24 hours
- Sales office open 8:30 am to 7:00 pm Saturdays 10:00 am to 3 pm EST
- For prepaid orders add \$2.75 for shipping and handling
- Should shipping and handling charges exceed \$2.75 the balance due will be sent C.O.D.



CALL TOLL FREE 1-800-543-4330
In Ohio 1-800-762-4315 • In Alaska and Hawaii 1-800-858-1849

RAMSEY

THE FIRST NAME IN ELECTRONIC TEST GEAR

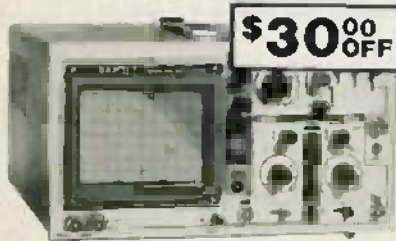

Save \$30 on the RAMSEY 20MHz Dual Trace Oscilloscope

Unsurpassed quality at an unbeatable price, the Ramsey oscilloscope compares to others costing hundreds more. Features include a component testing circuit for resistor,

capacitor, digital circuit and diode testing • TV video sync filter • wide bandwidth & high sensitivity • internal graticule • front panel trace rotator • Z axis • high sensitivity x-y mode • regulated power supply • built-in calibrator • rock solid triggering

Was \$399.95 NOW ONLY **\$369.95** high quality head on probes included

NEW 35 MHz DUAL TRACE OSCILLOSCOPE



A heavy duty and accurate scope for service as well as production use. Features include • wide frequency bandwidth • optimal sensitivity • extremely bright display • delayed triggering sweep • hold off • ALT trigger • single sweep • TV sync • 5X magnification • XY or XYZ operation • HFL/F noise reduction

3500 Dual Trace Oscilloscope **\$499.95** includes 2 high quality probes

ALL OSCILLOSCOPES INCLUDE 2 PROBES

NEW 15 MHz DUAL TRACE PORTABLE OSCILLOSCOPE



Ideal for field/bench applications, this scope can display up to 15 MHz signals. Internal battery pack allows up to 2 hours operation on a single charge. Features include • built-in battery charger • 5X horizontal magnification • high brightness CRT • front panel trace rotator • internal rechargeable battery pack

2500 Portable Oscilloscope **\$449.95** includes 2 high quality probes



NEW RAMSEY 1200 VOM MULTITESTER

Check transistors, diodes and LEDs with this Professional quality meter. Other features include: decimal scale • 20K volt metering system • 3 1/2" mirrored scale • polarity switch • 20 measuring ranges • safety probes • high impact plastic case

\$19.95 test leads and battery included



NEW RAMSEY D-4100 COMPACT DIGITAL MULTITESTER

Compact sized reliability and accuracy. This LCD digital multitester easily fits in your pocket, you can take it anywhere. It features full overload protection • 3 1/2 digit LCD readout • recessed input jacks • safety probes • diode check function • 2000 hours battery life

\$22.95 test leads and battery included

MINI KITS—EASY TO ASSEMBLE, FUN TO USE BEGINNERS & PROS WILL HAVE A GREAT TIME WITH THESE KITS

FM MINI MIKE



A super high performance FM wireless mini kit. Transmits a stable signal up to 300 yards with exceptional audio quality by means of its built in electret mike. Kit includes case, mike, on-off switch, antenna, battery and super instructions. This is the finest unit available.

FM-3 Kit **\$18.95**
FM-3 wired and tested **19.95**

Color Organ

See music come alive! 3 different lights flicker with music. One light each for, high, mid-range and bass. Each individually adjustable and drives up to 300 W! runs on 110VAC.

Complete kit, ML-1 **\$8.95**

Voice Modulator Kit

Converts any TV to voice modulator. Super stable, tunable over ch 4-8. Runs on 110V. accepts all video signals. Best unit on the market! Complete kit, VD-1 **\$9.95**

Super Stealth

A super sensitive amplifier which will pick up a pin drop at 15 feet! Great for monitoring baby's room or as general purpose amplifier. Full 7W rms output, runs on 6 to 15 volts, uses 8-45 ohm speaker. Complete kit, SV-9 **\$6.95**

CPO-1

Runs on 3-12 Vdc. I will out 1 KHz, good for CPO, Alarm, Audio Oscillator. Complete kit **\$2.95**

FM Wireless Mike Kit



Transmits up to 300 to any FM broadcast radio. Uses any type of mike. Runs on 3 to 9V Type FM-2 has added sensitive mike preamp stage.

FM-1 Kit **\$3.95** FM-7 Kit **\$4.95**

Whisper Light Kit

An interesting kit, small mike picks up sounds and converts them to light. The louder the sound, the brighter the light. Includes mike, controls up to 300 W! runs on 110 VAC. Complete kit, WL-1 **\$6.95**

Tone Decoder

A complete tone decoder on a single PC board. Features: 400-5000 Hz adjustable range w/ 20 turn pot, voltage regulation, 567 IC. Useful for touch-tone burst detection, FSK, etc. Can also be used as a stable tone encoder. Runs on 5 to 12 volts. Complete kit, TD-1 **\$5.95**

Steen Kit

Produces upward and downward well characteristic of a police siren. 5 W peak audio output runs on 3-15 volts, uses 3 ohm speaker. Complete kit, SM-3 **\$2.95**

Universal Tuner Kit

Provides the basic parts and PC board required to provide a source of precision timing and pulse generation. Uses 555 timer IC and includes a range of parts for most timing needs.

UT-5 Kit **\$8.95**

Mad Blaster Kit

Produces LOUD ear shattering and attention getting siren like sound. Gen supply up to 15 amps of obnoxious audio. Runs on 6-15 VDC.

MB-1 Kit **\$4.95**

30 Watt 2 mtr PWR AMP

Simple Class C Power amp features 8 times power gain. 1 W in for 8 out, 2 W in for 16 out, a 3 W in for 30 out. Max output of 35 W! Incredible value, complete with all parts, lens case and T-R relay.

PA-1, 30 W per amp kit **\$22.95**
1R-1, RF sensed T-R relay kit **6.95**

Power Supply Kit

Complete triple regulated power supply provides variable 1 to 16 volts at 200 ma and 5.81 5 Amp. Excellent load regulation, good filtering and small size. Less transformers, requires 6.3V @ 1 A and 24 VCT. Complete kit, PS-3LT **\$6.95**

CT-70 7 DIGIT 525 MHz COUNTER

Lab quality at a breakthrough price. Features • 3 frequency ranges each with presamp • dual selectable gate times • gate activity indicator • 50mV @ 150 kHz typical sensitivity • wide frequency range • 1 ppm accuracy

\$119.95 wired includes AC adapter
CT-70 kit **\$99.95**
BP-4 nicad pack **6.95**

CT-50 8 DIGIT 600 MHz COUNTER

CT-50 kit **\$129.95**
RA-1 receiver adapter kit **14.95**

CT-90 9 DIGIT 600 MHz COUNTER

The most versatile for less than \$300, features 3 selectable gate times • 9 digits • gate indicator • display hold • 25mV @ 150 MHz typical sensitivity • 10 MHz timebase for WWV calibration • 1 ppm accuracy

\$149.95 wired includes AC adapter
CT-90 kit **\$129.95**
OV-1 0.1 PPM oven (timebase) **\$9.95**
BP-4 nicad pack **6.95**

CT-125 9 DIGIT 1.2 GHz COUNTER

\$169.95 wired includes AC adapter
BP-4 nicad **\$8.95**

DM-700 DIGITAL MULTIMETER

Professional quality at a hobbyist price. Features include 28 different ranges and 8 functions • 3 1/2 digit, 1/2 inch LED display • automatic decimal placement • automatic polarity

\$119.95 wired includes AC adapter
DM-700 kit **\$99.95**
MP-1 probe set **6.95**

PR-2 COUNTER PREAMP

The PR-2 is ideal for measuring weak signals from 10 to 1,000 MHz • 20 dB gain • BNC connectors • great for measuring RF • ideal receiver/TV preamp

\$44.95 wired includes AC adapter
PR-2 kit **\$34.95**

PS-2 AUDIO MULTIPLIER

The PS-2 is handy for high resolution audio resolution measurements, multiplies up in frequency • great for RL tone measurements • multiplies by 10 or 100 • 0.01 Hz resolution & built-in signal preamp/conditioner

\$49.95 wired
PR-2 kit **\$39.95**

PS-10B 1.5 GHz PRESCALER

Extends the range of your present counter to 1.5 GHz • 2 stage preamp • divide by 1000 accurately • super sensitive (50 mV p-p) • BNC connectors • 1 GHz kit, 1 kHz out • drive any counter

\$79.95
PS-10-B prescaler **\$79.95**
also includes AC adapter

ACCESSORIES FOR RAMSEY COUNTERS

- Telescopic whip antenna—BNC plug .. **\$ 8.95**
- High impedance probe, light loading .. **18.95**
- Low pass probe, audio use .. **18.95**
- Direct probe, general purpose use .. **13.95**
- Tilt bail, for CT-70, 90, 125 .. **3.95**



PHONE ORDERS CALL **716-586-3950**

TELEX 468735 RAMSEY CI

TERMS • Satisfaction guaranteed • Exchange for 10 days. If not pleased, return in original form for refund • add 6% for shipping and insurance to a maximum of \$10.00 • overseas add 15% for surface mail • COD add \$2.00 (COD in USA only) • orders under \$15.00 add \$1.50 • NY residents add 7% sales tax • 90 day parts warranty on all kits • 1 year parts & labor warranty on all wired units



RAMSEY ELECTRONICS, INC.
2575 Baird Rd.
Penfield, N.Y. 14626

CIRCLE 70 ON FREE INFORMATION CARD

AUGUST 1986

ADVERTISING INDEX

RADIO-ELECTRONICS does not assume any responsibility for errors that may appear in the Index below.

Free Information Number	Page
81 A.I.S. Satellite	21
108 AMC Sales	30
76 AP Products	27
107 All Electronics	91
— Amazing Devices	90
77 B&K Precision	32
98.176 Beckman Industrial	9.22
85 Blue Star Industries	21
— BP	14.CV3
109 C & S Sales	38
— C.O.M.II.	12
— CIE	16
89 Cameo Enterprises	16
— Command Productions	72
79 Communications Electronics	3
— Coop's Satellite Digest	70
125 Copper Electronics	33
186 Crosley	21
127 Deco Industries	21
95 Dick Smith Electronics	100.101
82 Dig-Key	102
— Digital Research Computers	88
57 Digitron	88
124 Electronic Parts Outlet	108
— Electronic Technology Today	21.23
120 Elephant Electronics	21
184 Esoft Software	CD13
111,177 Etronix	16.84
100 FirestickII	74
121 Fluke Manufacturing	26
— Furdham Radio	13
— Grantham College of Engineering	25
— HW Sams	10
86 Heath	11
178 Hi-Shure	20
— ICS Computer Training	84
— ISET	90
65 J&W	92
59 JDR Instruments	CV4
113,179 JDR Microdevices	94.95
180,181 JDR Microdevices	96.97
182 JDR Microdevices	98
114 Jameco	104.105
104 Jan Crystals	30
87 MCM Electronics	106
93 Mark V. Electronics	103
187 Microprocessors Unltd.	CD13
117 Mouser	72
— NRI	34
110 Omnitron	28
— Pacific Cable	89
101 Pomona Electronics	7
126 RAG Electronics	5
78 Radio Shack	99
70 Ramsey	107
— RE Bookstore	83
183 Simpson	24
92 Tektronix	CV2
123 Test Probes	15
103 Wm B. Allen	31

SUB-MINIATURE D STYLE CONNECTORS

ORDER THE SUB-MINIATURE CONNECTORS FROM THE COMPUTER BOOKS BY:

Part No.	Price
88-A P100	\$4.00
88-B SOCKET	\$4.00
88-C P100	\$4.00
88-D SOCKET	\$4.00
88-E P100	\$4.00
88-F SOCKET	\$4.00
88-G P100	\$4.00
88-H SOCKET	\$4.00
88-I P100	\$4.00
88-J SOCKET	\$4.00
88-K P100	\$4.00
88-L SOCKET	\$4.00
88-M P100	\$4.00
88-N SOCKET	\$4.00
88-O P100	\$4.00
88-P SOCKET	\$4.00
88-Q P100	\$4.00
88-R SOCKET	\$4.00
88-S P100	\$4.00
88-T SOCKET	\$4.00
88-U P100	\$4.00
88-V SOCKET	\$4.00
88-W P100	\$4.00
88-X SOCKET	\$4.00
88-Y P100	\$4.00
88-Z SOCKET	\$4.00

CONNECTORS

I.C.E. STYLE CONNECTORS

Part No.	Price
88-25 P100	\$3.50
88-26 SOCKET	\$3.50
88-27 P100	\$3.50
88-28 SOCKET	\$3.50
88-29 P100	\$3.50
88-30 SOCKET	\$3.50
88-31 P100	\$3.50
88-32 SOCKET	\$3.50
88-33 P100	\$3.50
88-34 SOCKET	\$3.50
88-35 P100	\$3.50
88-36 SOCKET	\$3.50
88-37 P100	\$3.50
88-38 SOCKET	\$3.50
88-39 P100	\$3.50
88-40 SOCKET	\$3.50
88-41 P100	\$3.50
88-42 SOCKET	\$3.50
88-43 P100	\$3.50
88-44 SOCKET	\$3.50
88-45 P100	\$3.50
88-46 SOCKET	\$3.50
88-47 P100	\$3.50
88-48 SOCKET	\$3.50
88-49 P100	\$3.50
88-50 SOCKET	\$3.50
88-51 P100	\$3.50
88-52 SOCKET	\$3.50
88-53 P100	\$3.50
88-54 SOCKET	\$3.50
88-55 P100	\$3.50
88-56 SOCKET	\$3.50
88-57 P100	\$3.50
88-58 SOCKET	\$3.50
88-59 P100	\$3.50
88-60 SOCKET	\$3.50
88-61 P100	\$3.50
88-62 SOCKET	\$3.50
88-63 P100	\$3.50
88-64 SOCKET	\$3.50
88-65 P100	\$3.50
88-66 SOCKET	\$3.50
88-67 P100	\$3.50
88-68 SOCKET	\$3.50
88-69 P100	\$3.50
88-70 SOCKET	\$3.50
88-71 P100	\$3.50
88-72 SOCKET	\$3.50
88-73 P100	\$3.50
88-74 SOCKET	\$3.50
88-75 P100	\$3.50
88-76 SOCKET	\$3.50
88-77 P100	\$3.50
88-78 SOCKET	\$3.50
88-79 P100	\$3.50
88-80 SOCKET	\$3.50
88-81 P100	\$3.50
88-82 SOCKET	\$3.50
88-83 P100	\$3.50
88-84 SOCKET	\$3.50
88-85 P100	\$3.50
88-86 SOCKET	\$3.50
88-87 P100	\$3.50
88-88 SOCKET	\$3.50
88-89 P100	\$3.50
88-90 SOCKET	\$3.50
88-91 P100	\$3.50
88-92 SOCKET	\$3.50
88-93 P100	\$3.50
88-94 SOCKET	\$3.50
88-95 P100	\$3.50
88-96 SOCKET	\$3.50
88-97 P100	\$3.50
88-98 SOCKET	\$3.50
88-99 P100	\$3.50
88-100 SOCKET	\$3.50

RIBBON CABLE CONNECTORS

ORDER THE RIBBON CABLE CONNECTORS FROM THE COMPUTER BOOKS BY:

Part No.	Price
88-101	\$4.00
88-102	\$4.00
88-103	\$4.00
88-104	\$4.00
88-105	\$4.00
88-106	\$4.00
88-107	\$4.00
88-108	\$4.00
88-109	\$4.00
88-110	\$4.00
88-111	\$4.00
88-112	\$4.00
88-113	\$4.00
88-114	\$4.00
88-115	\$4.00
88-116	\$4.00
88-117	\$4.00
88-118	\$4.00
88-119	\$4.00
88-120	\$4.00
88-121	\$4.00
88-122	\$4.00
88-123	\$4.00
88-124	\$4.00
88-125	\$4.00
88-126	\$4.00
88-127	\$4.00
88-128	\$4.00
88-129	\$4.00
88-130	\$4.00
88-131	\$4.00
88-132	\$4.00
88-133	\$4.00
88-134	\$4.00
88-135	\$4.00
88-136	\$4.00
88-137	\$4.00
88-138	\$4.00
88-139	\$4.00
88-140	\$4.00
88-141	\$4.00
88-142	\$4.00
88-143	\$4.00
88-144	\$4.00
88-145	\$4.00
88-146	\$4.00
88-147	\$4.00
88-148	\$4.00
88-149	\$4.00
88-150	\$4.00

E-PROMS

Part No.	Price
2708 - 450ns	\$1.20
2716 - 450ns	\$1.50
2716 - 250ns	\$2.00
2732A - 450ns	\$3.00
2732B - 450ns	\$3.00
2732C - 250ns	\$3.00

RAMS

Part No.	Price
16K Dynamic - 200ns	\$1.20
16K Dynamic - 150ns	\$1.50
8K Dynamic - 200ns	\$1.50
256K Dynamic - 150ns	\$3.50
16K Static - 200ns	\$1.20
16K Static - 500ns	\$1.50
8K Static - 150ns	\$1.50
2114 1T09 Static	\$3.50

8000-810-8200 MEMORY IC's

Part No.	Price
8000-1	\$1.20
8000-2	\$1.50
8000-3	\$1.50
8000-4	\$1.50
8000-5	\$1.50
8000-6	\$1.50
8000-7	\$1.50
8000-8	\$1.50
8000-9	\$1.50
8000-10	\$1.50
8000-11	\$1.50
8000-12	\$1.50
8000-13	\$1.50
8000-14	\$1.50
8000-15	\$1.50
8000-16	\$1.50
8000-17	\$1.50
8000-18	\$1.50
8000-19	\$1.50
8000-20	\$1.50
8000-21	\$1.50
8000-22	\$1.50
8000-23	\$1.50
8000-24	\$1.50
8000-25	\$1.50
8000-26	\$1.50
8000-27	\$1.50
8000-28	\$1.50
8000-29	\$1.50
8000-30	\$1.50
8000-31	\$1.50
8000-32	\$1.50
8000-33	\$1.50
8000-34	\$1.50
8000-35	\$1.50
8000-36	\$1.50
8000-37	\$1.50
8000-38	\$1.50
8000-39	\$1.50
8000-40	\$1.50
8000-41	\$1.50
8000-42	\$1.50
8000-43	\$1.50
8000-44	\$1.50
8000-45	\$1.50
8000-46	\$1.50
8000-47	\$1.50
8000-48	\$1.50
8000-49	\$1.50
8000-50	\$1.50

ELECTRONIC PARTS OUTLET

2515 N. Scottsdale Road
Scottsdale, AZ 85257
(602) 941-9357
(602) 941-9377 (602) 941-9328, 9

(SEND FOR OUR FREE CATALOG)

MIN. ORDER \$20.00

Z80 SERIES SPECIALS

Part No.	Price
Z8000	\$1.50
Z8001	\$1.50
Z8002	\$1.50
Z8003	\$1.50
Z8004	\$1.50
Z8005	\$1.50
Z8006	\$1.50
Z8007	\$1.50
Z8008	\$1.50
Z8009	\$1.50
Z8010	\$1.50
Z8011	\$1.50
Z8012	\$1.50
Z8013	\$1.50
Z8014	\$1.50
Z8015	\$1.50
Z8016	\$1.50
Z8017	\$1.50
Z8018	\$1.50
Z8019	\$1.50
Z8020	\$1.50
Z8021	\$1.50
Z8022	\$1.50
Z8023	\$1.50
Z8024	\$1.50
Z8025	\$1.50
Z8026	\$1.50
Z8027	\$1.50
Z8028	\$1.50
Z8029	\$1.50
Z8030	\$1.50
Z8031	\$1.50
Z8032	\$1.50
Z8033	\$1.50
Z8034	\$1.50
Z8035	\$1.50
Z8036	\$1.50
Z8037	\$1.50
Z8038	\$1.50
Z8039	\$1.50
Z8040	\$1.50
Z8041	\$1.50
Z8042	\$1.50
Z8043	\$1.50
Z8044	\$1.50
Z8045	\$1.50
Z8046	\$1.50
Z8047	\$1.50
Z8048	\$1.50
Z8049	\$1.50
Z8050	\$1.50

GREAT PRICES! GUARANTEED 100%

Gernback Publications, Inc.
500-B Bi-County Blvd.
Farmingdale, NY 11735
(516) 293-3000
President: Larry Steckler
Vice President: Cathy Steckler

For Advertising ONLY 516-293-3000
Larry Steckler
publisher
Arline Fishman
advertising director
Shelli Weinman
advertising associate
Lisa Strassman
credit manager
Christina Estrada
advertising assistant

SALES OFFICES

EAST/SOUTHEAST

Stanley Levitan
Eastern Sales Manager
Radio-Electronics
259-23 57th Avenue
Little Neck, NY 11362
718-428-6037, 516-293-3000

MIDWEST/Texas/Arkansas/Okla

Ralph Bergen
Midwest Sales Manager
Radio-Electronics
540 Frontage Road—Suite 339
Northfield, IL 60093
312-446-1444

PACIFIC COAST/ Mountain States

Marvin Green
Pacific Sales Manager
Radio-Electronics
15335 Morrison St.—Suite 227
Sherman Oaks, CA 91403
818-966-2001

RADIO-ELECTRONICS

A Successful Union Of Traditional And Contemporary Design

The beauty, charm, simplicity of the Oak File Cabinet and the comfortable modern style of the Back Chair are more than just complementary pieces of furniture. They're handsome pieces which perform necessary functions in your home or business. Whether they stand united or alone they add a special dimension to your living area.

An Opulent Oak File

The two drawer oak file is made of solid wood with a beautifully polished oak veneer surface. Its pleasing simple lines blend with any interior bringing back the warmth and tradition of its early American counterparts. This handsome organizer has drawers which are 13 inches deep which fits standard files hanging from steel rails. Dimensions: 28-1/4"H x 16-1/4"W x 17"D.

Model **\$89⁹⁵**
CF-22



Discover The Comfort Of The Back Chair

Delight in the comfort and mobility of the Adjustable Back Chair with Casters. The Back Chair helps alleviate the discomfort of the conventional chair by changing the stress points on the body. Instead of forcing your lower back to support your weight by sitting at a 90° angle, the Back Chair balances your weight proportionally through your lower body and legs. In this new position your spine straightens naturally; you're able to relax and concentrate more efficiently. The Back Chair is user friendly and a viable alternative for those long hours at the computer, typewriter, desk or drawing board. The seat can be raised or lowered to accommodate each member of your household or business. Its handsome oak veneer finish allows it to blend with any decor.

Model CH-97
\$39⁹⁵

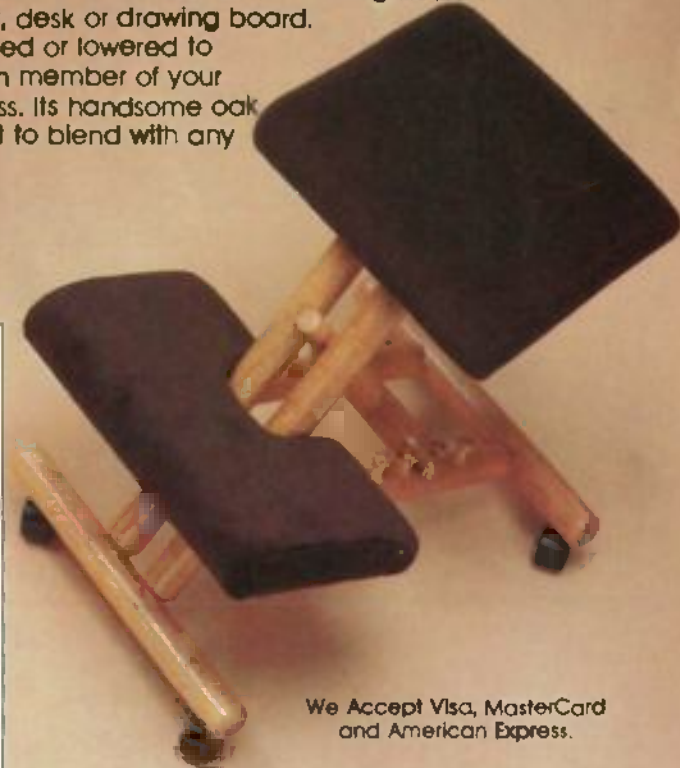

We Accept Visa, MasterCard
and American Express.

SEND
ORDER TO: **bp** 260 Motor Parkway, Hauppauge, NY 11788

Please send me _____ Back Chair(s) at \$39.95 ea.
Add \$5.50 shipping charge for each piece. Total _____

Please send me _____ Oak File(s) at \$89.95 ea.
Add \$10.50 shipping charge for each piece. Total _____

My Check or Money Order Is Enclosed.

Charge My Credit Card Visa MasterCard Amex

Card # _____

Signature _____ Exp. Date _____

Telephone: (_____) _____

Name _____

Address _____

City _____ State _____ Zip _____

Phone Orders Call Toll FREE out of state **800-645-9152**
NYS Toll FREE **800-832-1446 ext. 42**

PERFORMANCE

THAT IS OUT OF THIS WORLD...



\$389⁰⁰

**MODEL 2000 20MHz
DUAL TRACE**

\$549⁰⁰

**MODEL 3500 35MHz
DUAL TRACE DELAYED SWEEP**

...AT A DOWN TO EARTH PRICE

At last! Truly affordable test equipment with no compromise in design, and features you would expect to find only on oscilloscopes costing hundreds of dollars more! JDR Instruments presents two, new, high-performance models backed by a two year warranty and technical support which is only a phone call away. Perfect for the technician or advanced hobbyist, both models feature Dual Trace capability and a variety of operating and triggering modes, including CH-B Subtract and X-Y operation.

MODEL 2000 has a 20 MHz bandwidth and 20 calibrated sweeps ranging from .2s to .2 μ s. A convenient built-in component tester provides additional diagnostic power.

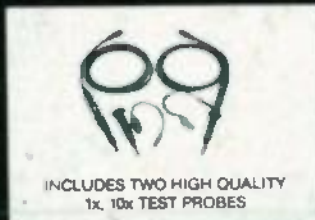

CIRCLE 59 ON FREE INFORMATION CARD

MODEL 3500 features a 35 MHz bandwidth and exceptional 1mV/DIV sensitivity. Delayed sweep and variable holdoff allow stable viewing of complex waveforms.

**ORDER TOLL FREE
800-538-5000
800-662-6279 (CA)**



JDR INSTRUMENTS

1224 South Bascom Avenue
San Jose, California 95128 (408) 995-5430

COPYRIGHT 1985 JDR INSTRUMENTS. EARTH PHOTO COURTESY OF NASA
THE JDR INSTRUMENTS LOGO IS A REGISTERED TRADEMARK OF JDR MICRODEVICES. JDR INSTRUMENTS IS A TRADEMARK OF JDR MICRODEVICES

www.americanradiohistory.com